

THE FAUNA OF BRITISH INDIA,

INCLUDING

CEYLON AND BURMA

*PUBLISHED UNDER THE AUTHORITY OF THE SECRETARY OF
STATE FOR INDIA IN COUNCIL.*

EDITED BY LT.-COL. R. B. S. SEWELL, C.I.E., Sc.D., F.R.S., I.M.S. (*ret.*)

NEMATODA.

VOL. I.

(ASCAROIDEA and STRONGYLOIDEA.)

BY

H. A. BAYLIS, M.A., D.Sc.,
*Assistant Keeper in the Department of Zoology,
British Museum (Natural History).*

L O N D O N :

TAYLOR AND FRANCIS, RED LION COURT, FLEET STREET.

March 23, 1936.

ALERE FLAMMAM.

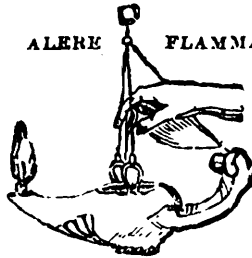

PRINTED BY TAYLOR AND FRANCIS

RED LION COURT, FLEET STREET.

CONTENTS.

	Page
AUTHOR'S PREFACE	v
REFERENCES	xi
SYSTEMATIC INDEX	xxxix
INTRODUCTION (GENERAL ACCOUNT OF THE CLASS NEMATODA)	1
GENERAL MORPHOLOGY	1
DEVELOPMENT	13
BIONOMICS AND LIFE-HISTORY	16
THE RELATIONSHIPS BETWEEN PARASITIC NEMA- TODES AND THEIR HOSTS	20
SPECIFICITY	23
TECHNIQUE	24
CLASSIFICATION	32
SYSTEMATIC ACCOUNT OF INDIAN NEMATODES	34
ALPHABETICAL INDEX	397

AUTHOR'S PREFACE.



IN the series of monographs published under the general title of 'The Fauna of British India,' the Nematoda have not hitherto found a place. Our knowledge of this group, as it occurs in India, Ceylon and Burma, is still rather scanty. Until recently almost the only observations on record were those made by British officials resident in India—usually members of the medical and veterinary services who, in the pursuit of their calling, were confronted with problems in which parasites played an important part. Thus it came about that a certain amount of information was accumulated concerning the Nematode parasites of man and the more important domestic animals. These parasites are, as might be expected, for the most part the same as those which occur in the same hosts in other parts of the world. Lists of records, principally based on material obtained from domestic animals in the Punjab, were published by Gaiger in 1910 and 1915.

From time to time material collected in India, Ceylon or Burma found its way into the hands of specialists such as Cobbold in England, Railliet in France, Parona in Italy and v. Linstow in Germany, and in this way a certain number of species new to science, from both domestic and wild animals, were described. The Museums at Calcutta and Colombo have played a valuable part in thus extending our knowledge, by forwarding material to European helminthologists for

determination. A few enthusiastic officers of the Indian Medical Service, such as Lt.-Col. F. H. Stewart and Lt.-Col. Clayton Lane, have taken up the study of Nematodes in India itself, working in more or less close conjunction with the Indian Museum.

The Zoological Survey of India, with its headquarters at the Indian Museum, has also done valuable work in preserving for study parasites obtained from animals that have been inmates of the Zoological Gardens, Calcutta, as well as those obtained by its own or other collectors from wild animals. Two considerable collections of material from these sources were entrusted to the writer by the late Dr. N. Annandale, then Director of the Zoological Survey of India, and were reported upon, in collaboration with Capt. R. Daubney, M.R.C.V.S., in 1922 and 1923. In these two reports a number of new species were added to the Indian fauna, and the known host-range of other species was extended. Since that time a fruitful collaboration has been established between the Zoological Gardens, Calcutta, and the Calcutta School of Tropical Medicine, whereby two helminthologists (Prof. A. C. Chandler and Dr. P. A. Maplestone), working successively in the latter institution, have been enabled to describe many new species and to extend still further our knowledge of the subject.

A few Indian zoologists are now taking up the study of helminthology, and a certain number of new forms of Nematodes have been described by them during the last decade. There is undoubtedly still room for a great deal of work of this kind, for the rich fauna of India still remains largely unexplored from the parasitological point of view.

Concerning Indian free-living Nematodes scarcely anything is yet known. H. J. Carter, an Assistant Surgeon in the Bombay Medical Establishment, appears to have been the first to devote any attention to them. Between the years 1855 and 1859 he described certain forms found in brackish

water or among algæ in open drains in Bombay, but unfortunately his descriptions are of little modern value. Nearly sixty years later Stewart described a few free-living species from Chilka Lake. Apart from these there are very few records, and there can be no doubt that the free-living Nematodes offer a very wide and almost untouched field for research. Little work, again, seems to have been done in India on the forms that attack crops. One species, the cause of the "ufra" disease of rice, was first discovered and described by Butler, working at the Agricultural Research Institute, Pusa.

Apart from the systematic aspect, much valuable work has been done in India on Nematodes of definite economic importance. Thus India has contributed a large share to the literature of ancylostomiasis, filariasis, dracontiasis and other human infestations, and species of importance in veterinary and agricultural science have received a considerable amount of attention.

From what has been said above it will be clear that the foundation for a systematic account of the Nematode fauna of India is as yet far from complete. The purpose of this book is simply to summarize, from the systematic point of view, the information at present available. The present volume deals only with the orders Ascaroidea and Strongyloidea (these terms being used in a wide sense). Some description is given of every species dealt with. In the majority of cases this is derived from the descriptions already available in the literature, and, when several descriptions of a species exist, an attempt has been made to combine them in such a way as to give the known extent of variation. A standardized order and style have been adopted in the descriptions, in order to facilitate reference and comparison. A brief summary of the life-history of the species, where this is known, is frequently added, and in some cases notes on its pathological and other aspects. No attempt, however, is made to deal fully with these matters, the scope of the work being primarily systematic.

It has not been found practicable to give satisfactory keys to the families and higher groups. Where keys to genera and species are given, it should be understood that they include only the genera or species of which descriptions follow, their sole purpose being to aid rapid reference to the descriptions. The keys themselves are of a purely artificial nature, and are not intended to indicate phylogenetic relationships.

It has been a somewhat difficult matter to decide what species should be regarded as falling within the scope of the work. Many parasites have been recorded outside India from animals of Indian origin, or animals known to occur in that country. Many species, on the other hand, have been recorded in India from animals imported from elsewhere and not indigenous. In either case the hosts have usually been kept in captivity, and the possibility cannot be excluded that their parasites may have been acquired after importation. Since some limit must be set to the extent of the work, it has seemed best, as a general rule, to ignore species not known to have been found in India, Ceylon or Burma, but to include those definitely recorded as occurring within these geographical boundaries, even when their hosts do not belong to the native fauna.

The names used for host-animals in this volume are for the most part those used in previously-published volumes of the 'Fauna of British India,' viz.,

Mammalia (First Edition), by W. T. Blanford (Part I, 1888; Part II, 1891).

Birds (Second Edition), by E. C. Stuart Baker (Synonymical Catalogue, Vols. VII and VIII, 1930).

Reptilia and Batrachia (First Edition), by G. A. Boulenger (1890).

Reptilia and Amphibia (Second Edition), by Malcolm A. Smith (Vol. I, Loricata, Testudines, 1931; Vol. II, Sauria, 1935).

Fishes (First Edition), by F. Day (Vols. I and II, 1889).

The writer desires to express his thanks to the numerous authors from whose descriptions material has been borrowed, and who have kindly allowed their illustrations to be copied, and in particular to Prof. C. L. Boulenger, Lt.-Col. Clayton Lane, Dr. P. A. Maplestone, D.S.O., and Prof. Warrington Yorke, F.R.S. Thanks are also due to the editors and publishers of the various journals and books from which illustrations have been borrowed for their permission to reproduce them; and in particular to the Government of India for permission to reproduce numerous figures from reports originally published in the Memoirs and Records of the Indian Museum, and to the Director of the Zoological Survey of India for the loan of the blocks.

To the Director of the Colombo Museum the author is indebted for enabling him to re-examine the type-specimens of certain species described by v. Linstow. This opportunity is also taken of expressing appreciation of the care and skill of Miss F. R. Mold in copying many of the illustrations, and finally of thanking the Editor for his valuable help and encouragement during the preparation of the work for publication.

H. A. BAYLIS.

*British Museum (Natural History),
London, S.W 7.*

March, 1936.

REFERENCES.

Note.—This list includes most of the more recent systematic literature covered by the volume, but only the more important of the older works. It does not, therefore, include the sources of all the names and synonyms mentioned in the systematic part. For these reference should be made to Stiles and Hassall's 'Index Catalogue of Medical and Veterinary Zoology': (1) "Authors"—'U.S. Dept. of Agriculture, Bureau of Animal Industry, Bulletin,' no. 39, parts 1-36, 1902-1912, and (2) "Subjects; Roundworms"—'U.S. Public Health Service, Hygienic Laboratory, Bulletin,' no. 114, 1920.

ACKERT, J. E.

1931. The Morphology and Life History of the Fowl Nematode *Ascaridia lineata* (Schneider). *Parasitol.* xxiii, pp. 360-379, pls. xiii, xiv.

ALESSANDRINI, G.

1905. Su di alcune Uncinariæ parassite dell'Uomo e di altri Vertebrati. *Boll. Soc. Zool. Ital.* xiv, pp. 23-48, pls. i-iv.
1909. Su di un raro Parassita dell'intestino del Majale e sul Genere *Globocephalus* Molin. *Arch. Parasitol.*, Paris, xiii, pp. 458-476.

BAER, J. G.

1930. Deux Helminthes nouveaux, parasites de *Uræotyphlus oxyurus* (Gray), Gymnophione de l'Inde méridionale. *Rev. Suisse Zool.* xxxvii, pp. 43-52.

BAIRD, W.

1853. *Catalogue of the Species of Entozoa, or intestinal Worms, contained in the Collection of the British Museum.* London.
1859, a. Description of a rare Entozoon from the Stomach of the Dugong. *Proc. Zool. Soc. Lond.* pp. 148-149, pl. lvi.
1859, b. Description of a new Species of Entozoon *Sclerostoma sipunculiforme*, from the intestines of the Elephant. *Proc. Zool. Soc. Lond.* pp. 425-427.

BASTIAN, H. C.

1865. Monograph on the Anguillulidæ, or free Nematoids, &c. *Trans. Linn. Soc. Lond.* xxv, pp. 73-184, pls. ix-xiii.

BAYLIS, H. A.

1920. On the Classification of the Ascaridæ.—I. The Systematic Value of certain Characters of the Alimentary Canal. *Parasitol.* xii, pp. 253–264.
1921. On the Classification of the Ascaridæ.—II. The *Polydelphis* group, &c. *Parasitol.* xii, pp. 411–426.
1923. On the Classification of the Ascaridæ.—III. A Revision of the Genus *Dujardinia* Gedoelst, with a Description of a new Genus of Anisakinæ from a Crocodile. *Parasitol.* xv, pp. 223–232.
1926. Some Parasitic Worms from Sarawak. *Sarawak Mus. Journ.* iii, pp. 303–322.
1927. On two new Species of *Oxysomatium* (Nematoda), with some Remarks on the Genus. *Ann. & Mag. Nat. Hist.* (9) xix, pp. 279–286.
1929. *A Manual of Helminthology, Medical and Veterinary.* London.
1932. A Comparison of certain Species of the Nematode Genus *Amidostomum*, with a Description of a new Species. *Ann. & Mag. Nat. Hist.* (10) x, pp. 281–286.
- 1933, a. On a Collection of Nematodes from Malayan Reptiles. *Ann. & Mag. Nat. Hist.* (10) xi, pp. 615–633.
- 1933, b. A new Species of the Nematode Genus *Uncinaria* from a Sea-lion, with some Observations on related Species. *Parasitol.* xxv, pp. 308–316.
1935. Two new Parasitic Nematodes from Ceylon. *Ann. & Mag. Nat. Hist.* (10) xvi, pp. 187–192.

BAYLIS, H. A., and DAUBNEY, R.

1922. Report on the Parasitic Nematodes in the Collection of the Zoological Survey of India. *Mem. Ind. Mus.*, Calcutta, vii, pp. 263–347.
- 1923, a. Preliminary Descriptions of three new parasitic Nematodes. *Ann. & Mag. Nat. Hist.* (9) xi, pp. 333–335.
- 1923, b. A further Report on parasitic Nematodes in the Collection of the Zoological Survey of India. *Rec. Ind. Mus.*, Calcutta, xxv, pp. 551–578.
1926. *A Synopsis of the Families and Genera of Nematoda.* London (British Museum (Nat. Hist.)).

BHALERAO, G. D.

1931. Two new Parasites from the King Cobra (*Naja hannah*). *Ann. & Mag. Nat. Hist.* (10) viii, pp. 102–109.
1932. On some Nematode Parasites of Goats and Sheep at Muktesar. *Ind. Journ. Vet. Sci. & Anim. Husb.* ii, pp. 242–254, pls. xvii–xx.
- 1933, a. On a few Nematodes parasitic in Goats at Muktesar. *Ind. Journ. Vet. Sci. & Anim. Husb.* iii, pp. 163–165, 1 pl.
- 1933, b. On two unrecorded Nematodes from the Abomasum of Cattle in India. *Ind. Journ. Vet. Sci. & Anim. Husb.* iii, pp. 166–173, 5 pls.
1934. On the Nematode causing Stomach Tumours of the Indian Crocodile, *Crocodilus palustris*. *Ind. Journ. Vet. Sci. & Anim. Husb.* iv, pp. 247–252.

BHALERAO, G. D. (*cont.*).

- 1935, *a.* Helminth Parasites of the Indian Elephant from the Andamans and Burma. *Ind. Journ. Vet. Sci. & Anim. Husb.* v, pp. 1-14.
- 1935, *b.* Helminth Parasites of the Domesticated Animals in India. *Imp. Council of Agric. Res., Delhi, Sci. Monogr.* No. 6, pp. 1-365.

BLOCH, M. E.

1782. *Abhandlung von der Erzeugung der Eingeweidewürmer und den Mitteln wider dieselben.* Berlin.

BOULENGER, C. L.

1916. Sclerostome Parasites of the Horse in England.—I. The Genera *Triodontophorus* and *Æsophagodontus*. *Parasitol.* viii, pp. 420-439, pl. xxii.
1917. Sclerostome Parasites of the Horse in England.—II. New Species of the Genus *Cylichnostomum*. *Parasitol.* ix, pp. 203-212.
1920. Intestinal Helminths in Indians in Mesopotamia. *Parasitol.* xii, pp. 95-97.
- 1921, *a.* Strongylid Parasites of Horses in the Punjab. *Parasitol.* xiii, pp. 315-326.
- 1921, *b.* On some Nematode Parasites of the Camel in India. *Parasitol.* xiii, pp. 311-314.
1922. On *Ascaris vitulorum* Goeze. *Parasitol.* xiv, pp. 87-92.
1926. Report on a Collection of Parasitic Nematodes, mainly from Egypt.—Part IV. Trichostrongylidæ and Strongylidæ. *Parasitol.* xviii, pp. 86-100.

BUTLER, E. J.

1913. Diseases of Rice. *Agric. Res. Inst., Pusa, Bull.* No. 34, 37 pp., pls. i-iii.
1919. The Rice Worm (*Tylenchus angustus*) and its Control. *Mem. Dept. Agric. India, Botanical Series*, x, 1, pp. 1-37.

CAMERON, T. W. M.

- 1924, *a.* On *Gaigeria pachyscelis* Railliet & Henry, 1910, a Nematode Parasite of Ruminants. *Journ. Helminthol.* ii, pp. 41-45.
- 1924, *b.* On the Nematode Genus *Globocephalus* Molin, 1861. *Journ. Helminthol.* ii, pp. 65-76.
1925. Some recent Advances in Veterinary Helminthology. *Ann. Rep., Nat. Vet. Med. Assoc. Gt. Britain & Ireland*, 1925, pp. 161-183.
1927. Studies on three new Genera and some little-known Species of the Nematode Family *Protostrongylidæ* Leiper, 1926. *Journ. Helminthol.* v, pp. 1-24.

CARTER, H. J.

1855. Note on *Dracunculus* in the Island of Bombay. *Tr. M. & Phys. Soc. Bombay* (1853-54) n. s. (2), pp. 45-46, pl. i, figs. 1-9.

CARTER, H. J. (*cont.*).

1858. Observations on *Dracunculus* in island of Bombay. *Ann. & Mag. Nat. Hist.* (3) i, pp. 410-414.
- 1859, *a.* Further observations on *Dracunculus* in the island of Bombay. [Same as 1858.] *Tr. M. & Phys. Soc. Bombay* (1857-58), n. s. (4), pp. 215-220.
- 1859, *b.* On *Dracunculus* and microscopic Filaridæ in the island of Bombay. *Ann. & Mag. Nat. Hist.* (3) iv, pp. 28-44, 98-116, pls. i-iii.

CHANDLER, A. C.

- 1925, *a.* The Species of *Strongyloides* (Nematoda). *Parasitol.* xvii, pp. 426-433.
- 1925, *b.* The Helminthic Parasites of Cats in Calcutta and the Relation of Cats to human helminthic Infections. *Ind. Journ. Med. Res.* xiii, pp. 213-227, pls. v-vi.
1926. New Heterakids from Indian Galliform Birds. *Ind. Journ. Med. Res.* xiii, pp. 617-623, pls. xxxi-xxxii.
- 1926-1928. The Prevalence and Epidemiology of Hookworm and other Helminthic Infections in India. *Ind. Journ. Med. Res.*
- | | | |
|------|-------|--|
| Part | I. | Vol. xiv, pp. 185-194 (1926). |
| | II. | „ xiv, pp. 195-218 (1926). |
| | III. | „ xiv, pp. 451-480 (1926). |
| | IV. | „ xiv, pp. 481-492 (1926). |
| | V. | „ xiv, pp. 493-504 (1926). |
| | VI. | „ xiv, pp. 733-744 + map (1927). |
| | VII. | „ xiv, pp. 745-759 (1927). |
| | VIII. | „ xiv, pp. 761-773 + 2 maps (1927). |
| | IX. | „ xiv, pp. 955-971 (1927). |
| | X. | „ xv, pp. 143-157 + tables & map (1927). |
| | XI. | „ xv, pp. 159-179 + tables & map (1927). |
| | XII. | „ xv, pp. 695-743 + 3 maps (1928). |
1931. New Genera and Species of Nematode Worms. *Proc. U.S. Nat. Mus.* lxxviii, Art. 23, pp. 1-11, incl. pls. i & ii.

CHATTERJI, R. C.

1933. On a new Nematode, *Parapharyngodon maplestoni*, gen. nov., sp. nov., from a Burmese Lizard. *Ann. Trop. Med. & Parasitol.*, Liverpool, xxvii, pp. 131-134.
1935. Nematodes from a common Indian Lizard (*Uromastix hardwicki*) with Remarks on *Kalicephalus parvus* Maplestone, 1932. *Rec. Ind. Mus.*, Calcutta, xxxvii, pp. 29-36.

CHITWOOD, B. G.

1930. The Structure of the Esophagus in the Trichuroidea. *Journ. Parasitol.* xvii, pp. 35-42, pls. v, vi.
1932. A new Species of Hookworm from a Philippine Civet. *Philippine Journ. Sci.* xlvii, pp. 259-263, pl. i.

CHITWOOD, B. G., and CHITWOOD, M. B.

1934. Somatic Musculature in Nematodes. *Proc. Helminthol. Soc. Washington*, i, pp. 9-10.

COBB, N. A.

1891. *Onyx* and *Dipeltis*: new Nematode Genera, with a Note on *Dorylaimus*. *Proc. Linn. Soc. N.S.W.*, Sydney, (2) vi, pp. 143-158.
1893. Nematodes, mostly Australian and Fijian. *Macleay Mem. Vol.*, *Linn. Soc. N.S.W.*, Sydney, pp. 252-308, pls. xxxvi-xlii.
1894. *Tricoma* and other new Nematode Genera. *Proc. Linn. Soc. N.S.W.*, Sydney, (2) viii, pp. 389-421.
1898. Extract from MS. Report on the Parasites of Stock. *Agric. Gaz. N.S.W.*, Sydney, ix, pp. 419-454.
1913. New Nematode Genera found inhabiting Fresh Water and non-brackish Soils. *Journ. Washington Acad. Sci.* iii, pp. 432-444.

COBBOLD, T. S.

1876. Notes on Entozoa.—Part 4. *Proc. Zool. Soc. Lond.* pp. 294-298, pl. xxi.
1879. *Parasites; a Treatise on the Entozoa of Man and Animals*. London.
1882. The Parasites of Elephants. *Trans. Linn. Soc. Lond.*, Zool. (2) ii, pp. 223-258, pls. xxiii, xxiv.
1884. New Parasites from the Horse and Ass. *Veterinarian*, London, lvii, pp. 4-7.

CONNAL, A.

1912. Some Nematode Worms from Lagos. *Journ. Lond. Sch. Trop. Med.* i, 3, pp. 229-237.

CREPLIN, F. C. H.

1845. Nachträge zu Gurlt's Verzeichniss der Thiere, bei welchen Entozoen gefunden worden sind. *Arch. f. Naturg.* xi, i, pp. 325-336.

DAUBNEY, R.

1923. The Kidney-Worm of Swine; a short Redescription of *Stephanurus dentatus* Diesing, 1839. *Journ. Comp. Pathol. & Therap.* xxxvi, pp. 97-103.

DESLONGCHAMPS, E. E.

1824. Art. "Ascaride." *Encycl. méthodique*, Paris, ii, pp. 83-112.

DIESING, K. M.

1839. Neue Gattungen von Binnenwürmern, &c. *Ann. Wien. Mus. Naturg.* ii, pp. 219-242, pls. xiv-xx.
1851. *Systema Helminthum*.—II. Vindobonæ.
1857. Sechzehn Arten von Nematoiden. *Denkschr. K. Akad. Wiss. Wien, Math.-Naturw. Cl.* xiii, 1 Abt., pp. 6-26, pls. i-iv.

DRASCHE, R. VON

1883. Revision der in der Nematoden-Sammlung des k.k. zoologischen Hofcabinetes befindlichen Original-Exemplare Diesing's und Molin's. *Verh. der k.-k. Zool.-bot. Ges.*, Wien, xxxii, (1882) pp. 117-138, pls. vii-x.

DUBINI, A.

1843. Nuovo verme intestinale umano (*Agchylostoma duodenale*), &c. *Ann. Univ. Med.*, Milano, cvi, pp. 5-13, pls. i, ii.

DUJARDIN, F.

1842. Mémoire sur les *Gordius* et les *Mermis*. *Compt. rend. Acad. Sci.*, Paris, xv, pp. 117-119.
1845. *Histoire naturelle des Helminthes*. Paris.

ERCOLANI, G. B.

1859. *Nuovi Elementi teorico-pratici di Medicina Veterinaria*. Bologna.

EVANS, G. H., and RENNIE, T.

1908. Notes on some Parasites in Burmah.—II. *Journ. Trop. Vet. Sci.*, Calcutta, iv, pp. 134-143, pls. v-viii.
1910. Notes on some Parasites in Burmah.—III. A few common parasites of Elephants. *Journ. Trop. Vet. Sci.*, Calcutta, v, pp. 240-250.

FAUST, E. C.

1933. Experimental Studies on Human and Primate Species of *Strongyloides*.—II. The Development of *Strongyloides* in the Experimental Host. *Amer. Journ. Hyg.* xviii, pp. 114-132.

FRÖLICH, J. A. VON

1802. Beiträge zur Naturgeschichte der Eingeweidewürmer. *Naturforscher*, Halle, xxix, pp. 5-96.

GAIGER, S. H.

1910. A Preliminary Check List of the Parasites of Indian Domesticated Animals. *Journ. Trop. Vet. Sci.*, Calcutta, v, pp. 65-71.
1915. A Revised Check List of the Animal Parasites of Domesticated Animals in India. *Journ. Comp. Pathol. & Therap.* xxviii, pp. 67-76.

GEBAUER, O.

1932. Zur Kenntnis der Parasitenfauna der Gemse. *Zeitschr. f. Parasitenk.*, Berlin, iv, pp. 147-219.

GEDOELST, L.

1916. Notes sur la Faune parasitaire du Congo belge. *Rev. Zool. Africaine*, v, Fasc. 1.

GENDRE, E.

1911. Sur quelques espèces d'Hétérakis du Dahomey. *Proc.-verb. Soc. Linn. Bordeaux*, lxxv, pp. 68-78.

GILES, G. M.

- 1892, a. On a new Sclerostome from the large intestine of Mules. *Scient. Mem. Med. Off. Army of India*, Calcutta, pt. 7, pp. 25-30, 1 pl.

GILES, G. M. (*cont.*).

- 1892 *b*. A Description of two new Nematode Parasites found in Sheep. *Sci. Mem. Med. Off. Army of India*, pt. 7, pp. 45-49. [Also *addendum* appended to the reprint.]

GMELIN, J. F.

1790. *Caroli à Linné Systema naturæ, &c. Editio decima tertia. Part 6*, pp. 3021-3910.

GODFREY, G. H.

1931. The Host Plants of the "Burrowing" Nematode, *Tylenchus similis*. *Phytopathology*, xxi, pp. 315-322.

GOEZE, J. A. E.

1782. *Versuch einer Naturgeschichte der Eingeweidewürmer thierischer Körper*. Blankenburg.

GOMEZ DE FARIA.

1910. Contribuição para a Sistemática helmintológica brasileira.— III. *Ankylostomum braziliense*, n. sp., Parasito dos Gatos e Cais. *Mem. Inst. Oswaldo Cruz*, Rio de Janeiro, ii, pp. 286-293, pl. xxii.

GOODEY, T.

1924. Oesophagostomes of Goats, Sheep and Cattle. *Journ. Helminthol.* ii, pp. 97-110.
1925. *Oesophagostomum longicaudum* n. sp. from the Pig in New Guinea. *Journ. Helminthol.* iii, pp. 45-50.
- 1932, *a*. On the Nomenclature of the Root-gall Nematodes. *Journ. Helminthol.* x, pp. 21-28.
- 1932, *b*. The Genus *Anguillulina* Gerv. & v. Ben., 1859, vel *Tylenchus* Bastian, 1865. *Journ. Helminthol.* x, pp. 75-180.
1933. *Plant Parasitic Nematodes and the Diseases they cause*. London.
1934. *Anguillulina cecidoplastes* n. sp., a Nematode causing Galls on the Grass, *Andropogon pertusus* Willd. *Journ. Helminthol.* xii, pp. 225-236.

HALL, M. C.

1916. Nematode Parasites of Mammals of the Orders Rodentia, Lagomorpha, and Hyracoidea. *Proc. U.S. Nat. Mus.*, Washington, 1, pp. 1-258, pl. i.
1921. Two new Genera of Nematodes, with a Note on a neglected Nematode Structure. *Proc. U.S. Nat. Mus.* lix, pp. 541-546.
1922. *Oxyuris compar* Leidy, 1856, a synonym of *Oxyuris ambigua* Rudolphi, 1819. *Journ. Parasitol.* ix, p. 44.

Hsü, H. F.

1933. Some Species of *Porrocaecum* (Nematoda) from Birds in China. *Journ. Parasitol.* xix, pp. 280-286, pls. ii, iii.

IHLE, J. E. W.

1919. Ueber *Ancylostoma perniciosum* v. Linst. und die Strongyliden des Elefanten. *Bijdragen tot de Dierk.* Afl. xxi, pp. 97-103.

NEM.

b

IHLE, J. E. W. (*cont.*).

1919. Notiz zu meinem Aufsatz "Ueber *Ancylostoma perniciosum* von Linstow und die Strongyliden des Elefanten." *Centralbl. f. Bakt. &c.*, 1 Abt., Orig., lxxxiii, p. 550.
1922. The Adult Strongylids (Sclerostomes) inhabiting the Large Intestine of the Horse. *Report of the Commission appointed to inquire into the Sclerostomiasis in Holland.—I.* Zoological Part. Vol. I. The Hague (National Printing Office). 118 pp.

IMPERIAL BUREAU OF AGRICULTURAL PARASITOLOGY.

1931. The Root-infesting Eelworms of the Genus *Heterodera*. A Bibliography and Host List, pp. viii + 99, 2 pls.

ISSHIKI, O.

1933. On a Nematode (*Hæmonchus similis* Travassos, 1914) from Corean Calves. *Journ. Jap. Soc. Vet. Sci.* xii, pp. 251–263, pls. xix, xx.

IYENGAR, M. O. T.

1929. Parasitic Nematodes of *Anopheles* in Bengal. *Trans. Far East. Ass. Trop. Med.*, 7th Congr., India, (Dec. 1927) iii, pp. 128–135, pl. vii.

JACKSON, J. B. S.

1847. *A descriptive Catalogue of the Anatomical Museum of the Boston Society for Medical Improvement.* Boston.

KAMENSKY, S. M.

1905. [The Systematic Position of the Genera *Metastrongylus*, Wost. and *Protostrongylus* g. n. among the other Strongylidæ.] *Sborn. Trud. Kharkov. Vet. Inst.* [N.V.]

KARVE, J. N.

- 1927, a. A new Nematode from a Burmese Tortoise (*Testudo emys*). *Ann. Trop. Med. & Parasitol.*, Liverpool, xxi, pp. 343–350.
- 1927, b. A Redescription of the Species *Oxysomatium macintoshii* (Stewart, 1914) (Nematoda). *Ann. & Mag. Nat. Hist.* (9) xx, pp. 620–628.
1930. Some Parasitic Nematodes of Frogs and Toads. *Ann. Trop. Med. & Parasitol.*, Liverpool, xxiv, pp. 481–491.

KENDRICK, J. F.

1929. The Correlation between the Size of Hookworm Egg-counts and the Degree of Anæmia in two Groups in Southern India. *Trans. Far East. Ass. Trop. Med.*, 7th Congr., India, (Dec. 1927) iii, pp. 216–238.

KHALIL, M.

- 1922, a. A Preliminary Note on some new Nematode Parasites from the Elephant. *Ann. & Mag. Nat. Hist.* (9) ix, pp. 212–216.
- 1922, b. A Revision of the Nematode Parasites of Elephants, with a Description of four new Species. *Proc. Zool. Soc. Lond.*, pt. ii, pp. 205–279.

KORKE, V. T.

1926. Observations on Ankylostomiasis in some Areas in British India.—Part III. Ankylostomiasis in the Bihar Area. *Ind. Journ. Med. Res.* xiv, 2, pp. 383–407, 1 sketch map.

KREIS, H. A.

1932. Studies on the Genus *Strongyloides* (Nematodes). *Amer. Journ. Hyg.* xvi, pp. 450–491.

LANE, C.

- 1913, a. *Agchylostoma ceylanicum*, a new Human Parasite. *Ind. Med. Gaz.* xlvi, pp. 216–218, 1 pl.
- 1913, b. *Trichostrongylus colubriformis* (Giles, 1892), a Human Parasite. *Ind. Med. Gaz.* xlvi, (4) 1 pl.
- 1914, a. Bursate Nematodes from the Indian Elephant. *Ind. Journ. Med. Res.* ii, pp. 380–398, pls. xlix–lx.
- 1914, b. Suckered Round-worms from India and Ceylon. *Ind. Journ. Med. Res.* ii, 2, pp. 655–669, pls. lxxiv–lxxxii.
- 1915, a. A further Note on Bursate Nematodes from the Indian Elephant. *Ind. Journ. Med. Res.* iii, pp. 105–108.
- 1915, b. *Falcaustra falcata*. An Investigation of *Oxysoma falcatum* von Linstow, 1906. *Ind. Journ. Med. Res.* iii, pp. 109–115, pls. iv, v.
1916. The Genus *Ancylostoma* in India and Ceylon. *Ind. Journ. Med. Res.* iv, pp. 74–92, pls. i–iii.
- 1917, a. *Bunostomum kashinathi* and the Ancylostomidae. *Ind. Journ. Med. Res.* iv, pp. 414–439, pls. xxxii–xxxv.
- 1917, b. *Gireterakis girardi* (n. g., n. sp.) and other Suckered Nematodes. *Ind. Journ. Med. Res.* iv, pp. 754–765, pls. xliii–xlvi.
- 1917, c. *Ancylostoma duodenale* as a Parasite of *Felis tigris*. *Ind. Journ. Med. Res.* v, pp. 210–216, pl. xxxi.
1921. Some Bursate Nematodes from Indian and African Elephants. *Ind. Journ. Med. Res.* ix, pp. 163–173, pls. xi–xvi.
- 1922, a. *Ancylostoma braziliense*. *Ann. Trop. Med. & Parasitol.*, Liverpool, xvi, pp. 347–352.
- 1922, b. A Preliminary Note on two Strongylata from Swine in the Pacific. *Ann. & Mag. Nat. Hist.* (9) ix, pp. 683–685.
1923. Some Strongylata. *Parasitol.* xv, pp. 348–364.

LEIDY, J.

1891. Notices of Entozoa. *Proc. Acad. Nat. Sci. Philadelphia*, (1890) pp. 410–418.

LEIPER, R. T.

1907. Two new Genera of Nematodes occasionally parasitic in Man. *Brit. Med. Journ.*, June 1st.

LEWIS, E. A.

1926. Observations on the Incidence of *Metastrongylus brevivaginat* and *Metastrongylus elongatus* in Pigs in Central Wales. *Journ. Helminthol.* iv, pp. 123–126.

LINSTOW, O. VON

1879. Helminthologische Studien. *Arch. f. Naturg.* xlv, i, pp. 165–188, pls. xi–xii.
1884. Helminthologisches. *Arch. f. Naturg.* l, i, pp. 125–145, pls. vii–x.
1885. Beobachtungen an bekannten und neuen Nematoden und Trematoden. *Arch. f. Naturg.* li, i, pp. 235–255, pls. xiii–xv.
1899. Nematoden aus der Berliner Zoologischen Sammlung. *Mitt. Zool. Mus. Berlin*, i, pp. 1–28, pls. i–vi.
1901. Helminthen von den Ufern des Nyassa-Sees, ein Beitrag zur Helminthen-Fauna von Süd-Afrika. *Jena. Zeitschr. f. Naturw.* xxxv. (n. F. xxviii), pp. 409–428, pls. xiii, xiv.
1902. Beobachtungen an neuen und bekannten Nemathelminthen. *Arch. f. mikr. Anat.* lx, pp. 217–232, pl. xiii.
- 1903, a. Parasiten, meistens Helminthen, aus Siam. *Arch. f. mikr. Anat.* lxii, pp. 108–121, pl. v.
- 1903, b. Entozoa des zoologischen Museums der Kaiserlichen Akademie der Wissenschaften zu St. Petersburg. 2. *Ann. Mus. Zool. Acad. Imp. d. Sc. de St.-Pétersb.* viii, pp. 265–294, pls. xvii–xix.
1904. Nematoda in the Collection of the Colombo Museum. *Spolia Zeylanica* i, pp. 91–104, pls. i, ii.
- 1905, a. Helminthen aus Ceylon und aus arktischen Breiten. *Zeitschr. f. wiss. Zool.* lxxxii, pp. 182–193, pl. xiii.
- 1905, b. Neue Helminthen. *Arch. f. Naturg.* lxxi, i, pp. 267–276, pl. x.
- 1906, a. Nematoden des zoologischen Museums in Königsberg. *Arch. f. Naturg.* lxxii, i, pp. 249–258.
- 1906, b. *Ascaris halicoris* Baird. *Journ. & Proc. Asiat. Soc. Bengal*, Calcutta, i, pp. 258–260, pl. xi.
- 1906, c. Parasites from the Gharial (*Gavialis gangeticus*, Geoffr.). *Journ. & Proc. Asiat. Soc. Bengal*, Calcutta, ii, pp. 269–271, pl. iii.
- 1906, d. Helminths from the Collection of the Colombo Museum. *Spolia Zeylanica* iii, pp. 163–188, pls. i–iii.
- 1907, a. Nematoden aus dem Königlichen zoologischen Museum in Berlin. *Mitt. Zool. Mus. Berlin*, iii, pp. 249–259, pls. vi, vii.
- 1907, b. The Fauna of Brackish Ponds at Port Canning, Lower Bengal.—Part II. A new Nematode of the Genus *Oncholaimus*. *Rec. Ind. Mus.*, Calcutta, i, pp. 45–46.
- 1907, c. *Ascaris lobulata*, Schneider, ein Parasit des Darms von *Platanista gangetica*. *Journ. & Proc. Asiat. Soc. Bengal*, Calcutta, iii, pp. 37–38.
1908. Recent Additions to the Collection of Entozoa in the Indian Museum. *Rec. Ind. Mus.*, Calcutta, ii, pp. 108–109.

Looss, A.

1900. Die Sclerostomen der Pferde und Esel in Egypten. *Centralbl. f. Bakt., &c.*, 1 Abt., xxvii, pp. 150–160, 184–192.
1902. The Sclerostomidae of Horses and Donkeys in Egypt. *Rec. Egypt. Govt. School. Med.*, Cairo, i, pp. 25–139, pls. i–xiii.
- 1905, a. Das Genus *Trichostrongylus*, n. g., mit zwei neuen gelegentlichen Parasiten des Menschen. *Centralbl. f. Bakt., &c.*, 1 Abt., Orig., xxxix, pp. 409–422, pls. i, ii.

LOOSS, A. (*cont.*).

- 1905, *b.* The Anatomy and Life History of *Agchylostoma duodenale* Dub. *Rec. Egypt. Govt. Sch. Med.*, Cairo, iii, pp. 1-158, pls. i-ix.
1911. The Anatomy and Life History of *Agchylostoma duodenale* Dub.—II. The Development in the free State. *Rec. Egypt. Govt. Sch. Med.*, Cairo, iv, pp. 159-613, pls. xi-xix.

LUCET, A., and HENRY, A.

1911. La Typhlite verruqueuse des Faisans et son Parasite (*Heterakis isolonche* v. Linstow). *Bull. Soc. centr. Méd. vét.* July 30, 1911.

LUNDAHL, C.

1848. Bemerkungen über zwei neue *Strongylus*-Arten. *Notis. Sällsk. pro Fauna et Flora Fenn. Förh.*, Helsingfors, 1 Häft., pp. 283-287.

MACFIE, J. W. S.

1922. The *Ascaris* of Cattle. *Ann. Trop. Med. & Parasitol.*, Liverpool, xvi, pp. 311-313.

MAPLESTONE, P. A.

- 1929, *a.* Two new Species of Nematodes from Indian Hosts. *Rec. Ind. Mus.*, Calcutta, xxxi, pp. 87-92.
- 1929, *b.* The Species Distribution of Hookworms in India. *Ind. Med. Gaz.* lxiv, pp. 159-164.
- 1930, *a.* Nematode Parasites of Pigs in Bengal. *Rec. Ind. Mus.*, Calcutta, xxxii, pp. 77-105.
- 1930, *b.* Parasitic Nematodes obtained from Animals dying in the Calcutta Zoological Gardens.—Parts 1-3. *Rec. Ind. Mus.*, Calcutta, xxxii, pp. 385-412.
1931. Parasitic Nematodes obtained from Animals dying in the Calcutta Zoological Gardens.—Parts 4-8. *Rec. Ind. Mus.*, Calcutta, xxxiii, pp. 71-171.
- 1932, *a.* The Genera *Heterakis* and *Pseudaspidodera* in Indian Hosts. *Ind. Journ. Med. Res.* xx, pp. 403-420, pls. xii-xiv.
- 1932, *b.* Parasitic Nematodes obtained from Animals dying in the Calcutta Zoological Gardens.—Parts 9-11. *Rec. Ind. Mus.*, Calcutta, xxxiv, pp. 229-261.

MAUPAS, E., and SEURAT, L. G.

1912. Sur un Nématode de l'intestin grêle du Dromadaire. *Compt. rend. Soc. Biol.*, Paris, lxxiii, pp. 628-632.

MAYNE, W. W., and SUBRAMHANYAM, V. K.

1933. Nematode Worms in Relation to the Cockchafer and Mealy Bug Problem in Coorg. *Mysore Coffee Exper. Stat., Dept. Agric.*, Bull. 11, 34 pp.

MEYER, A.

1896. Neue ceylonische Nematoden aus Säugetieren (*Filaria*, *Strongylus*) und aus *Julus (Oxyuris)*. Anatomisch-histologische Untersuchungen. *Arch. f. Naturg.* lxii, i, pp. 54-82 pls. iv, v.

MHASKAR, K. S.

1924. Report of the Ankylostomiasis Inquiry in Madras. *Indian Med. Res. Memoirs* [Supplementary Series to *Ind. Journ. Med. Res.*], No. 1, pp. i-vi, 1-95.

MIRZA, M. B., and SINGH, S. N.

1934. *Syphacia sciuri*, n. sp., a new Oxyurid-Worm from *Sciuris palmarum*. *Current Science* ii, pp. 345-346.

MITTER, S. N.

1912. Some Entozoa of Indian Elephants. *Journ. Comp. Pathol. & Therap.* xxv, pp. 111-115, 1 pl.

MOLIN, R.

1858. Prospectus helminthum, quæ in prodromo faunæ helminthologicae Venetiæ continentur. *Sitz. k. Akad. Wiss.*, Wien, xxx, pp. 127-158.
1860. Trenta specie di Nematoidi. *Sitz. k. Akad. Wiss.*, Wien, xl, pp. 331-358.
1861. Il Sottordine degli Acrofalli, &c. *Mem. R. Ist. Veneto* ix, (1860) pp. 427-633, pls. xxv-xxxiii.

MÖNNIG, H. O.

1931. Wild Antelopes as Carriers of Nematode Parasites of Domestic Ruminants.—Part I. *17th Rep. Dir. Vet. Serv.*, Pretoria, pt. i, sect. iv, pp. 233-254.
- 1932, a. The Genus *Agriostomum* with a Description of *A. cursoni* n. sp. *Journ. S. Afric. Vet. Med. Ass.* (1) iii, pp. 16-21.
- 1932, b. *Syngamus indicus*: A new Nematode from the Indian Elephant. *18th Rep. Dir. Vet. Serv. & Anim. Indust.*, Union of S. Africa, pp. 173-175.

MONTAGU, G.

1811. Account of a Species of *Fasciola* which infests the Trachea of Poultry, with a Mode of Cure. *Mem. Werner. Nat. Hist. Soc.*, Edinburgh, i, pp. 194-198, pl. vii.

MONTGOMERY, R. E.

1906. Observations on Bilharziosis among Animals in India. *Journ. Trop. Vet. Sci.*, Calcutta, i, pp. 15-46, 2 pls.

MORGAN, D. O.

1932. *Oxyuris stroma* Linstow, 1884. *Journ. Helminthol.* x, pp. 15-20.

MÜLLER, A.

1897. Helminthologische Mitteilungen. *Arch. f. Naturg.* lxxiii, i, pp. 1-26, pls. i-iii.

NAGATY, H. F.

1932. The Genus *Trichostrongylus* Looss, 1905. *Ann. Trop. Med. & Parasitol.*, Liverpool, xxvi, pp. 457-518.

OLT, A.

1932. Das Aneurysma verminosum des Pferdes und seine unbekanntenen Beziehungen zur Kolik. *Deutsch. Tierärztl. Wochenschr.* xl, pp. 326-332.

ORLOFF, I. W.

1933. Sur la reconstruction de la systématique du genre *Ostertagia* Ransom, 1907. *Ann. Parasitol.*, Paris, xi, pp. 96-114.

ORTLEPP, R. J.

1923. Observations on the Nematode Genera *Kalicephalus*, *Diaphanocephalus*, and *Occipitodontus* g. n., and on the Larval Development of *Kalicephalus philodryadus*, sp. n. *Journ. Helminthol.* i, pp. 165-189.

OWEN, R.

1833. *Descriptive and illustrated Catalogue of the Physiological Series of Comparative Anatomy contained in the Museum of the Royal College of Surgeons in London.* Vol. I. London.

PARONA, C.

- 1889, *a.* Intorno all'*Ascaris halicoris* Owen, ed a qualche altro Nematode raccolti in Assab dal Dott. V. Ragazzi. *Ann. Mus. Civ. Stor. Nat. Genova*, (2) vii (xxvii), pp. 751-764, pl. xiii.
- 1889, *b.* Sopra alcuni Elminti di Vertebrati Birmani raccolti da Leonardo Fea. *Ann. Mus. Civ. Stor. Nat. Genova*, (2) vii (xxvii), pp. 765-780, pl. iii.
1896. Di alcuni Nematodi dei Diplopodi. *Atti Soc. Ligust. Sci. Nat.*, Genova, vii, pp. 108-113, pl. i.
1898. Elminti raccolti dal Dott. Elio Modigliani alle Isole Mentawai, Engano e Sumatra. *Ann. Mus. Civ. Stor. Nat. Genova* xxxix, pp. 102-124, pl. i.

PATWARDHAN, S. S.

- 1935, *a.* On a new Oxyurid from a Squirrel. *Rec. Ind. Mus.*, Calcutta, xxxvii, pp. 11-13.
- 1935, *b.* Nematodes from the common Wall Lizard *Hemidactylus flavoviridis* (Ruppel). *Proc. Indian Acad. Sci.* i, pp. 376-380.

PIANA, G. P., and STAZZI, P.

1900. Elminti intestinali di una Elefantessa. *Arch. Parasitol.*, Paris, iii, pp. 509-529.

PRICE, E. W.

1930. *Wellcomia compar* (Leidy) the correct name for *Oxyuris compar* Leidy, 1856. *Journ. Parasitol.* xvi, p. 159.

QUIEL, G.

1919. *Poteriostomum* n. g., eine neue, beim Perde parasitierende Nematodengattung. *Centralbl. f. Bakt., &c.*, I Abt., Orig., lxxxiii, pp. 466-472.

RAILLIET, A.

1885. *Éléments de Zoologie médicale et agricole.* Paris.
1896. Sur les variations morphologiques des Strongles de l'appareil digestif, et sur un nouveau Strongle du Dromadaire. *Compt. rend. Soc. Biol.*, Paris, xlviii, pp. 540-542.

RAILLIET, A. (*cont.*).

1899. Syngamé laryngien du Bœuf. *Compt. rend. Soc. Biol.*, Paris, li, pp. 174-176.
1902. Sur quelques Scélérostomiens parasites des Ruminants et des Porcins. *Compt. rend. Soc. Biol.*, Paris, liv, pp. 107-110.
1918. Sur un Strongylidé vivant dans des kystes intestinaux chez les grands Félidés. *Bull. Soc. Path. exot.*, Paris, xi, pp. 93-98.
1923. Les Strongyles (anciens Sclerostomes) et les Strongyloses proprement dites. *Rec. Méd. Vét.*, Paris, xcix, pp. 377-396.

RAILLIET, A., and HENRY, A.

1902. Sur les Scélérostomiens des Équidés. *Compt. rend. Soc. Biol.*, Paris, liv, pp. 110-112.
1907. Sur les Variations des Strongyles de l'appareil respiratoire des Mammifères. *Compt. rend. Soc. Biol.*, Paris, lxiii, pp. 751-753.
- 1909, a. Sur la classification des Strongylidæ.—I. *Metastrongylinæ*. *Compt. rend. Soc. Biol.*, Paris, lxvi, pp. 85-88.
- 1909, b. Sur la classification des Strongylidæ.—II. *Ankylostominæ*. *Compt. rend. Soc. Biol.*, Paris, lxvi, pp. 168-171.
- 1910, a. Sur quelques helminthes du "Python sebæ" (Gmelin). *Bull. Soc. Path. exot.*, Paris, iii, pp. 94-98.
- 1910, b. Quelques Helminthes nouveaux ou peu connus du groupe des Bunostomiens. *Bull. Soc. Path. exot.*, Paris, iii, pp. 311-315.
1911. Recherches sur les Ascarides des Carnivores. *Compt. rend. Soc. Biol.*, Paris, lxx, pp. 12-15.
- 1912, a. Observations sur les Strongylidés du Genre *Nematodirus*. *Bull. Soc. Path. exot.*, Paris, v, pp. 35-39.
- 1912, b. Quelques Nématodes parasites des Reptiles. *Bull. Soc. Path. exot.*, Paris, v, pp. 251-259.
- 1912, c. Les Œsophagostomiens parasites de l'Homme. *Arch. Parasitol.*, Paris, xiv, pp. 562-583, pls. xxii-xxiv.
1913. Sur les Œsophagostomiens des Ruminants. *Bull. Soc. Path. exot.*, Paris, vi, pp. 506-511.

RAILLIET, A., HENRY, A., and BAUCHE, J.

1914. Sur les Helminthes de l'Eléphant d'Asie.—II-III. *Bull. Soc. Path. exot.*, Paris, vii, pp. 129-131, 207-210.
1915. Sur les Helminthes de l'Eléphant d'Asie. Note complémentaire. *Bull. Soc. Path. exot.*, Paris, viii, pp. 117-119.
1919. Un nouveau Strongylidé du Porc. *Bull. Soc. Path. exot.*, Paris, xii, pp. 324-332.

RAILLIET, A., HENRY, A., and JOYEUX, C.

1913. Un nouveau Strongylidé des Singes. *Bull. Soc. Path. exot.*, Paris, vi, pp. 264-267.

RANSOM, B. H.

1907. Notes on Parasitic Nematodes, including Descriptions of new Genera and Species, and Observations on Life Histories. *U.S. Dept. Agric., Bur. Anim. Indust., Circular 116*, 7 pp.

RANSOM, B. H. (cont.).

1911. The Nematodes parasitic in the Alimentary Tract of Cattle, Sheep, and other Ruminants. *U.S. Dept. Agric., Bur. Anim. Indust., Bull.* 127, pp. 1-132.

RAUTHER, M.

1918. Mitteilungen zur Nematodenkunde. *Zool. Jahrb., Anat. u. Ontog.*, xl, pp. 441-514, pls. xx-xxiv.
1930. Vierte Klasse des Cladus Nemathelminthes. Nematodes. Nematodea = Fadenwürmer: in Kükenthal and Krumbach, *Handbuch der Zoologie*, Berlin and Leipzig, ii, Lief. 8, pp. 249-402.

RUDOLPHI, C. A.

- 1808-1810. *Entozoorum sive Vermium intestinalium Historia naturalis*. Vols. I, II. Amstelædami.
1819. *Entozoorum Synopsis*. Berlin.

SANDGROUND, J. H.

1929. Some new parasitic Nematodes from Yucatan (Mexico), including a new Genus of Strongyle from Cattle. *Bull. Mus. Comp. Zool. Harvard Coll.* lxix, pp. 515-524, pls. i, ii.

SCHNEIDER, A.

1866. *Monographie der Nematoden*. Berlin.

SCHULTZ, O.

1899. Über das Austreten einer bisher unbekanntes *Mermis*-Art (*Mermis indica* nov. spec.) aus einem exotischen Dutenfalter. *Illust. Zeitschr. f. Entom.*, Neudamm, iv, pp. 132-133.

SCHWARTZ, B.

1928. Two new Nematodes of the Family Strongylidæ, parasitic in the intestines of Mammals. *Proc. U.S. Nat. Mus.* lxxiii, Art. 2, pp. 1-5, pls. i, ii.
1931. Nodular Worm Infestation of Domestic Swine. *Vet. Med.*, Chicago, xxvi, No. 11.

SCHWARTZ, B., and ALICATA, J. E.

1930. Two new Species of Nodular Worms (*Æsophagostomum*) parasitic in the Intestine of Domestic Swine. *Journ. Agric. Res.*, Washington, xl, pp. 517-522.

SEURAT, L. G.

1916. Sur les *Oxyures* des Mammifères. *Compt. rend. Soc. Biol.*, Paris, lxxix, pp. 64-68.

SHEATHER, A. L.

1919. A new Nematode causing Parasitic Gastritis in Calves. *Agric. Res. Inst., Pusa, Bull.*, Calcutta, No. 86, pp. 1-5, pls. i-v.

SHEATHER, A. L., and SHILSTON, A. W.

1920. *Syngamus laryngeus* in Cattle and Buffaloes in India. *Agric. Res. Inst., Pusa, Bull.*, Calcutta, No. 92, pp. 1-8, 8 pls.

SHIPLEY, A. E., and HORNEILL, J.

1904. The Parasites of the Pearl Oyster; in Herdman, W. A. *Roy. Soc. Rep. Pearl Fisheries*, pt. ii, pp. 77-106, pls. i-iv.

SIEBOLD, C. VON

1836. Helminthologische Beiträge. Zweiter Beitrag. *Syngamus trachealis*. Ein doppelreihiger Eingeweidewurm. *Arch. f. Naturg.* ii, i, pp. 105-116, pl. iii.

SKRJABIN, K. I.

1916. Nématodes des Oiseaux du Turkestan russe. *Ann. Mus. Zool. Petrograd*, xx, pp. 457-557, pl. viii.
 — Parassitische Trematoden und Nematoden, &c. *Scientific Results of the Zoological Exp. to Brit. E. Africa and Uganda made by Prof. V. Dogiel and I. Sokolow in the Year 1914*: Petrograd. Vol. I, No. 4. Russian, pp. 1-98. English translation, pp. 99-157, pls. i-x.
 1933. Sur la Position systématique des Nématodes du Genre *Oslerus* Hall, 1921. *Bull. Soc. Zool. France*, lviii, pp. 87-89.

SMIDT, H.

1906. Ueber einen neuen, beim Gibbon gefundenen *Strongylus* (*Strongylus ovatus* v. Linstow). *Centralbl. f. Bakt., &c.*, 1 Abt., Orig., xli, pp. 646-651.

SMITH, A. J., FOX, H., and WHITE, C. Y

1908. Contributions to Systematic Helminthology. *Univ. Pennsylv. Med. Bull.* xx, 12, pp. 283-294, pls. i-x (preceding text).

SPREHN, C.

1931. *Ascaridia lineata* (Schneider, 1866) der häufigste Spulwurm der Hühner. *Berl. tierärztl. Wochenschr.* xlvii, pp. 229-230.

STADELMANN, H.

1894. Ueber *Strongylus circumcinctus*, einen neuen Parasiten aus dem Labmagen des Schafes. *Sitz. Ges. Naturf. Fr. Berlin*, pp. 142-146.

STEKHOVEN, J. H. SCHUURMANS, Jr.

1928. Ueber *Strongyloides stercoralis* Bavay. *Tijdschr. Ned. Dierk. Ver.*, Leiden, (3) i, pp. 48-49.

STEWART, F. H.

- 1914, a. Studies in Indian Helminthology.—No. 1. *Rec. Ind. Mus.*, Calcutta, x, pp. 165-193, pls. xviii-xxiii.
 1914, b. Report on a Collection of free-living Nematodes from the Chilka Lake on the East Coast of India. *Rec. Ind. Mus.*, Calcutta, x, pp. 245-254, pls. xxx-xxxii.

STILES, C. W.

1902. A new Species of Hookworm (*Uncinaria americana*) parasitic in Man. *Amer. Med.*, Philadelphia, iii, pp. 777-778.

STILES, C. W. (*cont.*).

1903. Clinical Diagnosis of Intestinal Parasites. *Journ. Amer. Med. Ass.*, Chicago, xli, pp. 310-313.

STILES, C. W., and HASSALL, A.

1905. The Determination of Generic Types, and a List of Roundworm Genera, with their Original and Type Species. *U.S. Dept. Agric., Bureau of Animal Industry, Bull. No. 79*, 150 pp.

STOSSICH, M.

1896. Ricerche elmintologiche. *Boll. Soc. Adriat. Sci. Nat. Trieste* xvii, pp. 121-136, pls. iii, iv.
1899. Strongylidæ. Lavoro monografico. *Boll. Soc. Adriat. Sci. Nat. Trieste* xix, pp. 55-152.

SWEET, W. C.

1929. A Survey of Mysore State for Enlarged Spleens and for Hookworm and other Helminthic Infections. *Mysore Dept. Health, Bull. No. 7*, 53 pp.

TAYLOR, E. L.

1924. On the Ascarids of the Dog and Cat. *Ann. Trop. Med. & Parasitol.*, Liverpool, xviii, pp. 243-251.
- 1925, a. The Genus *Kiluluma*. *Ann. Trop. Med. & Parasitol.*, Liverpool, xix, pp. 53-55.
- 1925, b. Notes on some Nematodes in the Museum of the Liverpool School of Tropical Medicine.—II. *Ann. Trop. Med. & Parasitol.*, Liverpool, xix, pp. 57-69.

THAPAR, G. S.

1925. Studies on the Oxyurid Parasites of Reptiles. *Journ. Helminthol.* iii, pp. 83-150.
1929. Preliminary Observations on Ankylostomiasis in Pariah Dogs. *Trans. Far East. Ass. Trop. Med.*, 7th Congr., India, iii, pp. 265-267.

THEILER, GERTRUD.

1923. *The Strongylids and other Nematodes parasitic in the Intestinal Tract of South African Equines*. Pretoria: Govt. Printing and Stationery Office, pp. 1-175. [Also 9th and 10th Rep. Dir. Vet. Educ. and Res., Union of S. Africa (1924), pp. 601-773.]

THOMAS, L. J.

1924. Studies on the Life History of *Trichosomoides crassicauda* (Bellingham). *Journ. Parasitol.* x, pp. 105-136, pls. xiv-xviii.

THORNTON, H.

1924. A Review of the Oesophagostomes in the Collection of the Liverpool School of Tropical Medicine. *Ann. Trop. Med. & Parasitol.*, Liverpool, xviii, pp. 393-408.

THWAITE, J. W.

1927. On a Collection of Nematodes from Ceylon. *Ann. Trop. Med. & Parasitol.*, Liverpool, xxi, pp. 225-244.

TRAVASSOS, L.

- 1914, a. Trichostrongylinae brazileiras. (Nota prévia.) *Brazil Medico* No. 17.
- 1914, b. Trichostrongylinae brazileiras. (2 a. Nota prévia.) "Hæmonchus similis," n. sp. *Brazil Medico* No. 19.
1917. Trichostrongylinae brazileiras. (5 a. Nota prévia.) *Brazil Medico* xxxi, No. 9.
1921. Contribuições para o conhecimento da Fauna helmintologica brasileira.—XIII. Ensaio monografico da Familia Trichostrongylidæ Leiper, 1909. *Mem. Inst. Oswaldo Cruz*, Rio de Janeiro, xiii, pp. 5-135, pls. i-lvi.
1927. Nota sobre o *Ascaris vitulorum*. *Bol. Biol.*, S. Paulo, Fasc. 5, p. 22.
1933. Contribuição ao conhecimento do "*Deletrocephalus dimidiatus* Diesing," 1851, parasito da "*Rhea american*" Lath. *Arch. Esc. Sup. Agric. e Med. Vet.*, Rio de Janeiro, x, pp. 89-97, pls. xxii-xxvii.

TRAVASSOS, L., and VOGELSANG, E.

1932. Pesquisas helminthologicas realizadas em Hamburgo.—X. Contribuição ao conhecimento das espécies de *Æsophagostomum* dos Primatas. *Mem. Inst. Oswaldo Cruz*, Rio de Janeiro, xxvi, pp. 251-328, pls. lv-xci.

VEVERS, G. M.

1920. Report on Entozoa collected from Animals which died in the Zoological Gardens of London during eight months of 1919-1920. *Proc. Zool. Soc. Lond.*, pp. 405-410.

VOGEL, R.

1925. Zur Kenntnis der Fortpflanzung, Eireifung, Befruchtung und Furchung von *Oxyuris obvelata* Bremser. *Zool. Jahrb.*, Allg. Zool., &c., xlii, pp. 243-271, pl. i.

WALTON, A. C.

1923. Some new and little known Nematodes. *Journ. Parasitol.* x, pp. 59-70, pls. vi, vii.

WARE, F.

1924. Two Bursate Nematodes from the Indian Elephant. *Journ. Comp. Pathol. & Therap.* xxxvii, pp. 278-286.
1925. Two uncommon Parasites of Cattle. *Journ. Comp. Pathol. & Therap.* xxxviii, pp. 83-89.

WEDL, K.

1862. Zur Helminthenfauna Ägyptens. *Sitz. k. Akad. Wiss.*, Wien, xlv, Abth. i, pp. 463-482, pls. i-iii.

WITENBERG, G.

1925. Notes on Strongylidæ of Elephants. *Parasitol.* xvii, pp. 284-294.

YORKE, W., and MACFIE, J. W. S.

1918. Strongylidæ in Horses. *Ann. Trop. Med. & Parasitol.*, Liverpool, xi, pp. 399-416.

- 1919, a. Strongylidæ in Horses.—VI. *Cylicostomum pseudo-catinatum* sp. n. *Ann. Trop. Med. & Parasitol.*, Liverpool, xii, pp. 273-278.

- 1919, b. Strongylidæ in Horses.—VII. *Cylicostomum pateratum* sp. n. *Ann. Trop. Med. & Parasitol.*, Liverpool, xiii, pp. 57-62.

YORKE, W., and MAPLESTONE, P. A.

1926. *The Nematode Parasites of Vertebrates.* London.

ZEDER, J. G. H.

1800. *Erster Nachtrag zur Naturgeschichte der Eingeweidewürmer, &c.* Leipzig.

SYSTEMATIC INDEX.

	Page		Page
Order ASCAROIDEA <i>Railliet & Henry</i>	34	3. Gen. Porrocæcum <i>Railliet & Henry</i>	69
1. Fam. Ascaridæ <i>Cobbold</i>	34	1. <i>crassum</i> (<i>Deslongchamps</i>)	69
Subfam. ASCARINÆ <i>Travassos</i>	35	2. <i>depressum</i> (<i>Zeder</i>) .	70
1. Gen. Ascaris <i>Linnæus</i>	35	3. <i>angusticolle</i> (<i>Molin</i>)	71
1. <i>lumbricoides</i> <i>Linnæus</i>	36	4. <i>ardeæ</i> (<i>Frölich</i>)	73
2. <i>equorum</i> <i>Goeze</i>	39	5. <i>reticulatum</i> (<i>v. Linstow</i>).	74
3. <i>vitulorum</i> <i>Goeze</i>	41	6. <i>pristis</i> <i>Baylis & Daubney</i>	75
4. <i>sp.</i>	43	7. <i>galeocerdonis</i> <i>Thwaite</i>	77
2. Gen. Ophidascaris <i>Baylis</i>	44	8. <i>sp.</i>	78
1. <i>filaria</i> (<i>Dujardin</i>)	44	9. [<i>Ascaris</i>] <i>quadrata</i> <i>v. Linstow</i>	78
2. <i>gestri</i> (<i>Parona</i>)	46	4. Gen. Contracæcum <i>Railliet & Henry</i>	79
3. <i>naïæ</i> (<i>Gedoelst</i>)	46	1. <i>spiculigerum</i> (<i>Rudolphi</i>).	79
3. Gen. Polydelphis <i>Dujardin</i> .	48	2. <i>microcephalum</i> (<i>Rudolphi</i>)	81
1. <i>anoura</i> <i>Dujardin</i> .	49	3. <i>rosarium</i> (<i>Connal</i>)	82
2. <i>attenuata</i> (<i>Molin</i>) .	51	4. <i>haliaëti</i> <i>Baylis & Daubney</i>	83
3. <i>oculata</i> (<i>v. Linstow</i>) . .	52	5. <i>tricuspe</i> (<i>Gedoelst</i>)	84
4. <i>brachycheilos</i> (<i>v. Linstow</i>)	52	6. <i>engonium</i> <i>Baylis & Daubney</i>	85
5. <i>sewelli</i> <i>Baylis & Daubney</i>	54	7. <i>lobulatum</i> (<i>Schneider</i>)	87
6. <i>rotundicaudata</i> (<i>v. Linstow</i>)	56	8. <i>incurvum</i> (<i>Rudolphi</i>) .	88
7. <i>sp.</i>	58	9. <i>plagiostomorum</i> (<i>v. Linstow</i>)	90
8. <i>sp.</i>	58	10. <i>trichiuri</i> <i>Thwaite</i> . .	91
4. Gen. Toxocara <i>Stiles</i>	58	11. <i>balistis</i> (<i>v. Linstow</i>)	92
1. <i>canis</i> (<i>Werner</i>)	59	[larval forms]	92
2. <i>mystax</i> (<i>Zeder</i>)	60	5. Gen. Paranisakis <i>Baylis</i> .	92
3. <i>elephantis</i> (<i>Rudolphi</i>)	60	1. <i>pastinacæ</i> (<i>Rudolphi</i>).	92
5. Gen. Toxascaris <i>Leiper</i>	62	2. [<i>Ascaris</i>] <i>meleagrinae</i> <i>v. Linstow</i>	94
1. <i>leonina</i> (<i>v. Linstow</i>) .	62	3. [<i>Ascaris</i>] <i>balisticola</i> <i>v. Linstow</i>	95
2. <i>transfuga</i> (<i>Rudolphi</i>)	63	6. Gen. Dujardinia <i>Gedoelst</i>	95
Subfam. ANISAKINÆ <i>Railliet & Henry</i>	66	1. <i>helicina</i> (<i>Molin</i>)	96
1. Gen. Belanisakis <i>Maplestone</i> .	66	2. <i>woodlandi</i> <i>Baylis</i>	97
1. <i>ibidis</i> <i>Maplestone</i>	67	3. <i>halicoris</i> (<i>Owen</i>) . .	99
2. Gen. Raphidascaris <i>Railliet & Henry</i> . .	67	7. Gen. Multicæcum <i>Baylis</i>	100
1. <i>diadonis</i> <i>Thwaite</i>	68	1. <i>agile</i> (<i>Wedl</i>)	100

	Page		Page
8. Gen. Polycæcum <i>Maplestone</i>	102	Subfam. SUBULURINÆ <i>Travassos</i>	150
1. gangeticum <i>Maplestone</i>	102	1. Gen. Subulura <i>Molin</i>	150
9. Gen. Typhlophoros <i>v. Linstow</i>	104	1. andersoni (<i>Cobbold</i>)	151
1. lamellaris <i>v. Linstow</i>	104	2. sarasinorum (<i>Meyer</i>)	153
10. Gen. Amplicæcum <i>Baylis</i>	105	3. galloperdicis <i>Baylis & Daubney</i>	153
1. varani <i>Baylis & Daubney</i>	105	4. turnicis <i>Maplestone</i>	154
11. Gen. Goezia <i>Zeder</i>	107	5. multipapillata (<i>Chandler</i>)	156
1. gavialidis <i>Maplestone</i>	107	3. Fam. Kathlaniidæ <i>Travassos</i>	158
Appendix to Fam. Ascaridæ	108	1. Gen. Kathlania <i>Lane</i>	158
1. "Ascaris" cynonycteridis <i>Parona</i>	108	1. leptura (<i>Rudolphi</i>)	159
2. "Ascaris" brachyura <i>v. Linstow</i>	109	2. chiloscyllii <i>Thwaite</i>	160
3. "Ascaris" tigridis <i>Gmelin</i>	109	2. Gen. Tonaudia <i>Travassos</i>	162
2. Fam. Heterakidæ <i>Railliet & Henry</i>	110	1. tonaudia (<i>Lane</i>)	162
Subfam. HETERAKINÆ <i>Railliet & Henry</i>	110	3. Gen. Spironoura <i>Leidy</i>	163
1. Gen. Heterakis <i>Dujardin</i>	111	1. testudinis (<i>Baylis & Daubney</i>)	164
1. gallinæ (<i>Gmelin</i>)	112	2. barbi (<i>Baylis & Daubney</i>)	165
2. indica <i>Maplestone</i>	115	3. leptcephala (<i>Baylis & Daubney</i>)	167
3. pavonis <i>Maplestone</i>	115	4. falcata (<i>v. Linstow</i>)	168
4. pusilla <i>v. Linstow</i>	116	5. brevispiculata <i>Baylis</i>	170
5. bosia <i>Lane</i>	116	6. stewarti (<i>Baylis & Daubney</i>)	171
6. vulvolabiata <i>Chandler</i>	118	7. onama <i>Karve</i>	173
7. parva <i>Maplestone</i>	118	4. Gen. Zanclophorus <i>Baylis & Daubney</i>	174
8. isolonche <i>v. Linstow</i>	119	1. annandalei <i>Baylis & Daubney</i>	174
9. papillosa (<i>Bloch</i>)	121	2. kempfi <i>Baylis & Daubney</i>	177
10. beramporia <i>Lane</i>	122	3. [Heterakis] feæ <i>Parona</i>	179
11. hamulus <i>v. Linstow</i>	123	5. Gen. Cruzia <i>Travassos</i>	179
12. spumosa <i>Schneider</i>	123	1. orientalis <i>Maplestone</i>	180
13. girardi (<i>Lane</i>)	125	6. Gen. Cissophyllus <i>Railliet & Henry</i>	181
14. govindi (<i>Karve</i>)	126	1. laverani <i>Railliet & Henry</i>	181
2. Gen. Pseudaspidodera <i>Baylis & Daubney</i>	127	7. Gen. Probstmayria <i>Ransom</i>	182
1. pavonis <i>Baylis & Daubney</i>	128	1. simiæ <i>Maplestone</i>	183
2. voluptuosa <i>Chandler</i>	131	4. Fam. Oxyuridæ <i>Cobbold</i>	184
3. spinosa <i>Maplestone</i>	132	Subfam. OXYURINÆ <i>Hall</i>	184
3. Gen. Ascaridia <i>Dujardin</i>	133	1. Gen. Oxyuris <i>Rudolphi</i>	185
1. galli (<i>Schrank</i>)	133	1. equi (<i>Schrank</i>)	185
2. compar (<i>Schrank</i>)	136	2. poculum <i>v. Linstow</i>	188
3. columbæ (<i>Gmelin</i>)	137	2. Gen. Enterobius <i>Leach</i>	188
4. cristata (<i>v. Linstow</i>)	139	1. vermicularis (<i>Linnæus</i>)	189
5. stroma (<i>v. Linstow</i>)	140	2. anthropopithecii (<i>Geddes</i>)	191
6. trilabium (<i>v. Linstow</i>)	141	3. Gen. Thelandros <i>Wedl</i>	192
4. Gen. Strongyluris <i>Müller</i>	142	1. micruris <i>Rauther</i>	192
1. chamæleonis <i>Baylis & Daubney</i>	142	2. baylisi <i>Chatterji</i>	194
2. calotis <i>Baylis & Daubney</i>	145	3. taylori <i>Chatterji</i>	194
5. Gen. Spinicauda <i>Travassos</i>	147	4. kasauli <i>Chatterji</i>	195
1. cophotis <i>Baylis</i>	147	5. maplestoni (<i>Chatterji</i>)	195
6. Gen. Africana <i>Travassos</i>	149		
1. varani <i>Maplestone</i>	149		

	Page		Page
6. hemidactylus <i>Patwardhan</i>	196	8. Fam. Anguillulini <i>Baylis & Daubney</i>	225
7. "Oxyuris" megaloon <i>v. Linstow</i>	197	Subfam. ANGUILLULININÆ	
4. Gen. <i>Syphacia</i> <i>Seurat</i>	198	<i>Baylis & Daubney</i>	225
1. <i>sciuri</i> <i>Mirza & Singh</i>	198	1. Gen. <i>Anguillulina</i> <i>Gervais & v. Beneden</i>	226
2. spp.	199	1. <i>tritici</i> (<i>Steinbuch</i>)	226
Subfam. COSMOCERCINÆ		2. <i>similis</i> (<i>Cobb</i>)	228
<i>Railliet</i>	200	3. <i>angusta</i> (<i>Butler</i>)	229
1. Gen. <i>Oxysomatium</i> <i>Railliet & Henry</i>	200	4. <i>pratensis</i> (<i>de Man</i>)	230
1. <i>macintoshii</i> (<i>Stewart</i>)	201	5. <i>cecidoplastes</i> <i>Goodey</i>	231
2. Gen. <i>Syphaciella</i> <i>Mönnig</i>	202	2. Gen. <i>Heterodera</i> <i>Schmidt</i>	231
1. <i>indica</i> <i>Maplestone</i>	203	1. <i>marioni</i> (<i>Cornu</i>)	232
Oxyuridæ of uncertain position ("Oxyuris" <i>sens. lat.</i>)	204	Subfam. DORYLAIMINÆ <i>Baylis & Daubney</i>	233
1. <i>Oxyuris sciuri</i> <i>Hall</i>	204	1. Gen. <i>Dorylaimus</i> <i>Dujardin</i>	234
2. <i>Oxyuris longicaudata</i> <i>Meyer</i>	205	1. <i>palustris</i> (<i>Carter</i>)	234
3. <i>Oxyuris</i> sp.	205	2. sp.	234
4. <i>Oxyuris</i> sp.	205	2. Gen. <i>Hoplolaimus</i> <i>Daday</i>	235
Appendix to Fam. Oxyuridæ.	205	1. <i>squamosus</i> (<i>Cobb</i>)	235
1. <i>Oxyuris compar</i> <i>Leidy</i>	205	9. Fam. Trilobidæ <i>Micoletzky</i>	236
5. Fam. Atractidæ <i>Travassos</i>	206	1. Gen. <i>Monhystera</i> <i>Bastian</i>	236
1. Gen. <i>Atractis</i> <i>Dujardin</i>	207	1. <i>megalaima</i> <i>Stewart</i>	237
1. <i>granulosa</i> (<i>Railliet & Henry</i>)	207	2. <i>uria</i> <i>Stewart</i>	237
2. <i>opeatura</i> <i>Leidy</i>	208	2. Gen. <i>Fimbrilla</i> <i>Cobb</i>	238
2. Gen. <i>Crossocephalus</i> <i>Railliet</i>	209	1. <i>tenuis</i> (<i>Cobb</i>)	238
1. <i>brevicaudatus</i> <i>Baylis & Daubney</i>	210	3. Gen. <i>Symplocostoma</i> <i>Bastian</i>	239
3. Gen. <i>Monhysterides</i> <i>Baylis & Daubney</i>	210	1. <i>barbatum</i> (<i>Carter</i>)	239
1. <i>piscicola</i> <i>Baylis & Daubney</i>	211	10. Fam. Alaimidæ <i>Micoletzky</i>	240
2. <i>kachugæ</i> (<i>Stewart</i>)	213	1. Gen. <i>Diplopeltis</i> <i>Cobb</i>	240
6. Fam. Rhabditidæ <i>Micoletzky</i>	214	1. <i>minor</i> (<i>Cobb</i>)	240
Subfam. RHABDITINÆ <i>Micoletzky</i>	214	11. Fam. Oncholaimidæ <i>Baylis & Daubney</i>	241
1. Gen. <i>Rhabdias</i> <i>Stiles & Hassall</i>	214	Subfam. ONCHOLAIMINÆ	
1. <i>escheri</i> <i>Baer</i>	215	<i>Micoletzky</i>	241
2. Gen. <i>Strongyloides</i> <i>Grassi</i>	215	1. Gen. <i>Oncholaimus</i> <i>Dujardin</i>	241
1. <i>stercoralis</i> (<i>Bavay</i>)	216	1. <i>indicus</i> <i>v. Linstow</i>	242
2. <i>felis</i> <i>Chandler</i>	219	2. <i>chilkensis</i> <i>Stewart</i>	243
3. <i>papillosus</i> (<i>Wedl</i>)	220	2. Gen. <i>Chromadora</i> <i>Bastian</i>	243
7. Fam. Mermithidæ <i>Braun</i>	221	1. <i>ocellata</i> (<i>Carter</i>)	244
1. Gen. <i>Mermis</i> <i>Dujardin</i>	222	Subfam. DESMODORINÆ <i>Baylis & Daubney</i>	244
1. <i>nigrescens</i> <i>Dujardin</i>	222	1. Gen. <i>Thoracostoma</i> <i>Marion</i>	244
2. sp.	224	1. <i>indicum</i> (<i>Stewart</i>)	245
3. <i>indica</i> <i>v. Linstow</i>	225	Order STRONGYLOIDEA	
NEM.		<i>Weinland</i>	246
		12. Fam. Strongylidæ <i>Baird</i>	246
		Subfam. STRONGYLINÆ <i>Railliet</i>	247
		1. Gen. <i>Strongylus</i> <i>Müller</i>	247

	Page		Page
Subgen. <i>Strongylus</i> <i>Railliet</i>	248	2. <i>falcifera</i> (<i>Cobbold</i>)	280
1. <i>equinus</i> <i>Müller</i> ..	248	3. <i>indica</i> (<i>Ware</i>)	281
Subgen. <i>Alfortia</i> <i>Railliet</i>	250	4. Gen. <i>Khalilia</i> <i>Neveu-Lemaire</i> .	282
2. <i>edentatus</i> (<i>Looss</i>) ...	250	1. <i>pileata</i> (<i>Railliet, Henry</i>	282
Subgen. <i>Delafondia</i> <i>Railliet</i>	251	& <i>Bauche</i>)	284
3. <i>vulgaris</i> (<i>Looss</i>)	251	5. Gen. <i>Quilonia</i> <i>Lane</i> .	284
Subgen. <i>Decrusia</i> <i>Lane</i> .	251	1. <i>renniei</i> (<i>Railliet</i> &	284
4. <i>additicius</i> <i>Railliet, Henry</i>	252	<i>Henry</i>) . . .	286
& <i>Bauche</i> .	252	2. <i>travancra</i> <i>Lane</i> ..	286
2. Gen. <i>Triodontophorus</i> <i>Looss</i> .	253	6. Gen. <i>Kiluluma</i> <i>Skrjabin</i>	286
1. <i>minor</i> <i>Looss</i>	254	1. <i>stylosa</i> (<i>v. Linstow</i>) .	287
2. <i>serratus</i> (<i>Looss</i>) .	254	7. Gen. <i>Bourgelatia</i> <i>Railliet,</i>	288
3. <i>brevicauda</i> <i>Boulenger</i> .	255	<i>Henry & Bauche</i> .	288
3. Gen. <i>Œsophagodontus</i> <i>Rail-</i>	256	1. <i>diducta</i> <i>Railliet, Henry</i>	288
<i>liet & Henry</i>	256	& <i>Bauche</i>	288
1. <i>robustus</i> (<i>Giles</i>)	256		
4. Gen. <i>Equinurbia</i> <i>Lane</i> ..	258	Subfam. ŒSOPHAGOSTOMINÆ	
1. <i>sipunculiformis</i> (<i>Baird</i>).	258	<i>Railliet</i>	290
5. Gen. <i>Choniangium</i> <i>Railliet,</i>	259		
<i>Henry & Bauche</i>	259	1. Gen. <i>Œsophagostomum</i>	
1. <i>epistomum</i> (<i>Piana</i>)	260	<i>Molin</i>	290
2. <i>sp.</i>	261	1. <i>dentatum</i> (<i>Rudolphi</i>)	292
6. Gen. <i>Deletrocephalus</i>		2. <i>quadrispinulatum</i> (<i>Mar-</i>	294
<i>Diesing</i>	261	<i>cone</i>)	294
1. <i>dimidiatus</i> <i>Diesing</i> .	262	3. <i>brevicaudum</i> <i>Schwartz &</i>	294
		<i>Alicata</i>	294
Subfam. TRICHONEMINÆ		4. <i>maplestonei</i> <i>Schwartz</i>	295
<i>Railliet</i>	264	5. <i>venulosum</i> (<i>Rudolphi</i>)	296
1. Gen. <i>Trichonema</i> <i>Cobbold</i> . . .	264	6. <i>asperum</i> <i>Railliet &</i>	297
Subgen. <i>Trichonema</i> <i>Cobbold</i> .	265	<i>Henry</i>	297
1. <i>longibursatum</i> (<i>Yorke &</i>	265	7. <i>columbianum</i> (<i>Curtice</i>)	297
<i>Macfie</i>)	265	8. <i>indicum</i> <i>Maplestone</i> .	299
2. <i>calicatum</i> (<i>Looss</i>)	267	9. <i>blanchardi</i> <i>Railliet &</i>	300
3. <i>minutum</i> (<i>Yorke & Mac-</i>	267	<i>Henry</i>	302
<i>fie</i>) ..	267	10. <i>ovatum</i> (<i>v. Linstow</i>) .	302
4. <i>poculatum</i> (<i>Looss</i>) ..	268	11. <i>tridentatum</i> <i>Maple-</i>	303
Subgen. <i>Cylicostomum</i> <i>Ihle</i>	268	<i>stone</i>	304
5. <i>ægyptiacum</i> <i>Railliet</i>	269	12. <i>traguli</i> (<i>Maplestone</i>) .	304
6. <i>coronatum</i> (<i>Looss</i>)	270	2. Gen. <i>Bosicola</i> <i>Sandground</i>	305
7. <i>labiatum</i> (<i>Looss</i>) ..	270	1. <i>radiatus</i> (<i>Rudolphi</i>)	306
Subgen. <i>Cylicocyclus</i> <i>Ihle</i>	271	2. <i>curvatus</i> (<i>Maplestone</i>)	307
8. <i>insigne</i> (<i>Boulenger</i>)	271	3. <i>traguli</i> (<i>Chandler</i>) .	307
9. <i>nassatum</i> (<i>Looss</i>) ..	272	3. Gen. <i>Chabertia</i> <i>Railliet &</i>	308
9 a. var. <i>parvum</i> <i>Yorke &</i>	272	<i>Henry</i>	308
<i>Macfie</i>	272	1. <i>ovina</i> (<i>Gmelin</i>)	308
Subgen. <i>Cylicocercus</i> <i>Ihle</i>	272		
10. <i>catinatum</i> (<i>Looss</i>) ..	273	Subfam. STEPHANURINÆ	
10 a. var. <i>pseudo-catina-</i>		<i>Railliet, Henry &</i>	309
<i>tatum</i> (<i>Yorke & Mac-</i>		<i>Bauche</i>	309
<i>fie</i>) ..	274		
11. <i>goldi</i> (<i>Boulenger</i>)	274	1. Gen. <i>Stephanurus</i> <i>Diesing</i>	309
12. <i>pateratum</i> (<i>Yorke &</i>	275	1. <i>dentatus</i> <i>Diesing</i>	310
<i>Macfie</i>)	275		
2. Gen. <i>Poteriostomum</i> <i>Quiel</i>	276	Subfam. SYNGAMINÆ <i>Baylis</i>	
1. <i>imparidentatum</i> <i>Quiel</i> .	276	& <i>Daubney</i>	312
3. Gen. <i>Murshidia</i> <i>Lane</i> .	278		
1. <i>murshida</i> <i>Lane</i>	278	1. Gen. <i>Syngamus</i> <i>v. Siebold</i>	312
		1. <i>trachea</i> (<i>Montagu</i>)	312

	Page		Page
2. laryngeus <i>Railliet</i>	315	2. indicus <i>Ortlepp</i>	347
3. indicus <i>Monnig</i>	315	3. longior <i>Maplestone</i> .	348
13. Fam. Ancylostomidæ (<i>Looss</i>)		4. elongatus <i>Maplestone</i> .	349
<i>Lane</i> ..	317	5. brachycephalus <i>Maple-</i>	
Subfam. ANCYLOSTOMINÆ		<i>stone</i>	350
(<i>Looss</i>) <i>Stephens</i> .	317	6. minutus (<i>Baylis & Daub-</i>	
1. Gen. <i>Ancylostoma</i> (<i>Dubini</i>)		<i>ney</i>)	351
<i>Creplin</i>	317	7. fimbriatus (<i>Ortlepp</i>)	354
1. duodenale (<i>Dubini</i>)	318	8. ersiliae (<i>Stossich</i>).	355
2. caninum (<i>Ercolani</i>) .	320	9. sp.	356
3. minimum (<i>v. Linstow</i>) .	321		
4. braziliense (<i>Gomez de</i>		15. Amidostomidæ <i>Baylis &</i>	
<i>Faria</i>)	321	<i>Daubney</i>	356
5. malayanum (<i>Alessan-</i>		1. Gen. <i>Amidostomum</i> <i>Railliet</i>	
<i>drini</i>)	322	& <i>Henry</i>	356
2. Gen. <i>Galoncus</i> <i>Railliet</i> . . .	323	1. skrjabini <i>Boulenger</i>	357
1. perniciosus (<i>v. Linstow</i>).	323	2. Gen. <i>Pseudamidostomum</i>	
3. Gen. <i>Agriostomum</i> <i>Railliet</i> .	324	<i>Boulenger</i>	359
1. vryburgi <i>Railliet</i>	324	1. bouleñgeri <i>Maplestone</i> .	359
Subfam. NECATORINÆ <i>Lane</i> .	326	3. Gen. <i>Epomidiostomum</i>	
1. Gen. <i>Necator</i> <i>Stiles</i> . . .	326	<i>Skrjabin</i>	360
1. americanus (<i>Stiles</i>) .	327	1. uncinatum (<i>Lundahl</i>)	360
2. Gen. <i>Globocephalus</i> <i>Molin</i>	328		
1. urosubulatus (<i>Alessan-</i>		16. Fam. Trichostrongylidæ	
<i>drini</i>)	328	<i>Leiper</i>	361
2. connorfilii <i>Lane</i>	329	Subfam. TRICHOSTRONGYLINÆ	
3. samoensis <i>Lane</i>	330	<i>Leiper</i>	361
3. Gen. <i>Bunostomum</i> <i>Railliet</i> .	331	1. Gen. <i>Trichostrongylus</i> <i>Looss</i> .	362
1. trigonocephalum (<i>Rudol-</i>		1. colubriformis (<i>Giles</i>)	362
<i>phi</i>)	331	2. probolurus (<i>Railliet</i>) .	364
2. cobii <i>Maplestone</i>	333	3. pigmentatus (<i>v. Linstow</i>)	365
3. bovis <i>Maplestone</i>	334	2. Gen. <i>Ostertagia</i> <i>Ransom</i>	366
4. phlebotomum (<i>Railliet</i>)	334	1. ostertagi (<i>Stiles</i>)	366
4. Gen. <i>Gaigeria</i> <i>Railliet &</i>		2. circumcincta (<i>Stadel-</i>	
<i>Henry</i>	335	<i>mann</i>)	367
1. pachyscelis <i>Railliet &</i>		3. marshalli <i>Ransom</i>	369
<i>Henry</i>	335	4. occidentalis <i>Ransom</i> .	370
5. Gen. <i>Uncinaria</i> <i>Frölich</i> . .	336	5. mentulata <i>Railliet &</i>	
1. stenocephala (<i>Railliet</i>).	337	<i>Henry</i>	372
2. longespiculum <i>Maple-</i>		3. Gen. <i>Ornithostrongylus</i> <i>Tra-</i>	
<i>stone</i>	338	<i>vassos</i>	372
6. Gen. <i>Tetragomphius</i> <i>Baylis</i>		1. travassosi <i>Maplestone</i>	373
& <i>Daubney</i>	339	4. Gen. <i>Hæmonchus</i> <i>Cobb</i> .	373
1. procyonis <i>Baylis &</i>		1. contortus (<i>Rudolphi</i>)	374
<i>Daubney</i>	339	2. similis <i>Travassos</i> . .	378
7. Gen. <i>Grammocephalus</i> <i>Rail-</i>		3. longistipes <i>Railliet &</i>	
<i>liet & Henry</i>	341	<i>Henry</i>	378
1. varedatus <i>Lane</i>	341	5. Gen. <i>Nematodirus</i> <i>Ransom</i> .	379
8. Gen. <i>Bathmostomum</i> <i>Railliet</i>		1. filicollis (<i>Rudolphi</i>)	380
& <i>Henry</i>	343	2. mauritanicus <i>Maupas &</i>	
1. sangeri (<i>Cobbold</i>)	343	<i>Seurat</i>	381
14. Fam. Diaphanocephalidæ		6. Gen. <i>Mecistocirrus</i> <i>Railliet &</i>	
<i>Travassos</i>	344	<i>Henry</i>	382
1. Gen. <i>Kalicephalus</i> <i>Molin</i>	344	1. digitatus (<i>v. Linstow</i>)	382
1. willeyi <i>v. Linstow</i>	345		

	Page		Page
7. Gen. <i>Oswaldocruzia</i> <i>Travassos</i> . . .	384	2. Gen. <i>Dictyocaulus</i> <i>Railliet & Henry</i>	389
1. <i>filiformis</i> (<i>Goeze</i>).	384	1. <i>filaria</i> (<i>Rudolphi</i>)	389
Appendix to Subfam. <i>Trichostrongylinæ</i>	385	2. <i>unequalis</i> <i>Bhalerao</i>	391
" <i>Strongylus</i> " <i>costatus</i> <i>Meyer</i> .	385	3. <i>viviparus</i> (<i>Bloch</i>)	391
		4. <i>arnfieldi</i> (<i>Cobbold</i>) . . .	392
17. Fam. <i>Metastrongylidæ</i>		3. Gen. <i>Varestrongylus</i> <i>Bhalerao</i>	392
<i>Leiper</i>	386	1. <i>pneumonicus</i> <i>Bhalerao</i>	393
1. Gen. <i>Metastrongylus</i> <i>Molin</i> .	387	4. Gen. <i>Protostrongylus</i> <i>Kamen-sky</i>	394
1. <i>elongatus</i> (<i>Dujardin</i>)	387	1. <i>rufescens</i> (<i>Leuckart</i>).	394
		5. Gen. <i>Oslerus</i> <i>Hall</i> .	395
		1. <i>osleri</i> (<i>Cobbold</i>)	396

INTRODUCTION.

GENERAL ACCOUNT OF THE CLASS NEMATODA.

THE Nematodes or Threadworms are a group of animals whose relationships to the rest of the animal kingdom are extremely obscure. In text-books of zoology the group is commonly treated as part of a phylum NEMATHELMINTHES, along with the ACANTHOCEPHALA and the NEMATOMORPHA or GORDIACEA. There is, however, no real evidence that the Nematodes are at all closely related to these groups, from which, in structure and in development, they differ widely. Certain arguments have been advanced in favour of considering them remotely related to the ARTHROPODA *, but it must be admitted that the evidence is very unconvincing. In short, no useful purpose seems to be served by speculation concerning the origin or affinities of the group, and the only course open to us at present is to regard them as an independent class of animals.

GENERAL MORPHOLOGY.

Body-wall.

A typical Nematode is a cylindrical or spindle-shaped, more or less elongate, unsegmented animal, tapering somewhat towards each end. The body is covered externally with a tough, resistant cuticle, which is elastic and flexible, but only to a very small degree extensible. This cuticle can generally be seen to be composed of two or more layers, and is almost invariably marked throughout the body with a regular series of annular grooves, known as striations. In a living Nematode the cuticle is usually firm and taut, but in some species it may show a certain amount of transverse wrinkling, allowing of additional flexibility. The cuticle may form local excrescences of very various kinds, such as bristles, spines, scales or bosses. Bristles are most frequently present in free-living forms, in which they occur chiefly at or near the extremities, and generally appear to be sensory

* For a discussion of this question see Baylis, 1924, *Ann. & Mag. Nat. Hist.* (9) xiii, p. 165.

organs, connected with fine nerve-terminations. Spines or scales, almost always arranged in transverse rings, occur on the cuticle of many parasitic species, belonging to various families, and probably serve either as clinging organs or as aids in creeping or burrowing. At the sides of the body the cuticle is often raised into a pair of longitudinal ridges or flanges, termed lateral alæ. These probably serve as "fins," and assist in the eel-like swimming type of locomotion. Frequently the alæ are confined to the anterior region of the body, or become much narrower posteriorly. When conspicuous only in the "neck" region they are often called cervical alæ. Occasionally an ala is present on one side only, or one is more highly developed than the other. Multiple longitudinal ridges or crests occur on the cuticle of certain forms, particularly among the Trichostrongylidæ, in addition to, or instead of, lateral alæ. In the males of many Nematodes there are special lateral expansions of the cuticle near the posterior end of the body, known as caudal alæ. These assist in copulation, being applied to or wrapped round the body of the female. In the STRONGYLOIDEA the caudal alæ assume a highly specialized form, being developed into a more or less bell-shaped expansion which surrounds the posterior extremity and is called the bursa.

The cuticle is the product of the secretion of the subcuticular layer. This is a syncytium, or sheet of nucleated protoplasm without definite cell-boundaries. Immediately below this is the main musculature of the body. This consists of a single layer of muscle-cells whose contractile fibres are arranged longitudinally, in such a way as to produce, by their contraction, dorso-ventral bending of the body. Locomotion is effected in all Nematodes by successive undulations, the worms "swimming" in the surrounding liquid or semi-liquid medium in a manner suggestive of that of eels or snakes, but differing from it in that their undulations are always in an "up-and-down" and not in a lateral direction. When placed in a drop of liquid on a flat surface, a living Nematode invariably lies on its side, and after death its body almost always assumes the same position. The muscle-cells take various forms and show various types of arrangement. Fundamentally each individual cell consists of a contractile portion and a non-contractile protoplasmic portion. Schneider, in 1860, distinguished two main types, which he named "platymyarian" and "cœlomyarian." In the former the contractile substance forms a flat, rhomboidal sheet on the surface of the cell nearest to the subcuticular layer. In the latter the non-contractile or medullary protoplasm of the cell is partly enclosed in the contractile substance, which forms a spindle-shaped tube or groove, allowing the medullary protoplasm to project only

in the middle, where the nucleus is also situated. In both types of muscle-cell the medullary portion may give off processes which connect it with neighbouring cells or run obliquely or transversely to be inserted into the body-wall at the mid-dorsal or mid-ventral line, where they are possibly connected with one of the main longitudinal nerves. Schneider, in later publications, replaced the terms platymyarian and cœlomyarian by others, and attempted to use the types of musculature as a basis of classification. In his 'Monographie der Nematoden' (1866) he recognized three types. The first, "polymyarian," corresponds with the former cœlomyarian type, and is that familiar in *Ascaris*, where the muscle-cells are numerous and irregularly arranged. The second, or "meromyarian," corresponds with the platymyarian type. Here the musculature is composed of a small number (at most eight) of longitudinal rows of flattened, rhomboidal cells. In the third, or "holomyarian," type the muscles were said by Schneider to be undivided, or divided only longitudinally.

As a systematic basis Schneider's types of musculature have proved unsatisfactory, and have now been generally discarded. The forms placed by him in the "holomyarian" group have been found to show in reality modifications of the polymyarian arrangement, while the polymyarian and meromyarian types are found to occur in closely-related forms or even together in a single species. There is, however, some reason for regarding these two types of musculature as stages in evolutionary development, as has been suggested by Rauther (1930) and by Chitwood and Chitwood (1934). Some species which are cœlomyarian (polymyarian) as adults have been found to be platymyarian (meromyarian) as larvæ, and this fact agrees with the supposition that the platymyarian type is the more primitive.

The musculature of the body-wall is divided, in almost all Nematodes, into four sectors by four longitudinal "chords" or internal thickenings of the subcuticular layer. Two of these thickenings, known as the lateral fields, run along the sides of the body, and are usually well developed, broad and prominent. The others, situated in the mid-dorsal and mid-ventral lines, are narrow and less conspicuous. In a few forms there are eight muscle-sectors and eight "chords."

The musculature encloses a body-cavity, filled with fluid, which is traversed by the alimentary canal and contains also the reproductive organs. The body-cavity is not a completely clear space, but is crossed in places by strands of a kind of fibrous connective tissue, and by some muscle-fibres connecting parts of the alimentary canal and other organs with the body-wall. The connective or "mesenteric" tissue

covers the musculature internally and the outer surface of the alimentary canal and other organs in the body-cavity, which are thus supported and kept in place by it.

Alimentary Canal.

The mouth is situated at the anterior end of the body, terminally or subterminally, and may or may not be surrounded by lip-like structures. It appears probable that the most primitive types are those in which three lips are present, one being dorsal and two subventral. Triradial symmetry, of which the three-lipped condition is an expression, is a feature constantly appearing in the morphology of the group. It is, in all existing forms, combined with a bilateral symmetry, and it seems possible that the latter was, at some remote ancestral period, superimposed upon it. It has even been suggested that the Nematodes are the descendants of a sessile type of organism, the habit possessed by many free-living forms of anchoring themselves by the tail, by means of a sticky secretion, being regarded as a survival of an ancestral mode of life. When three lips are present, each usually carries on its outer surface two of the six sensory papillæ with which the heads of almost all Nematodes are provided. In other forms the three lips are replaced by a pair of lateral lips, each carrying three papillæ. In others, again, the lips have disappeared, but the papillæ are still present on the surface of the cuticle surrounding the mouth. In some forms secondary lip-like structures, independent of the papillæ, have been developed.

The mouth may lead directly into the œsophagus, or anterior portion of the alimentary canal. Frequently, however, it does so indirectly, through a special cavity or vestibule, which may have thickened cuticular or chitinous walls, and in which various kinds of tooth-like projections or other elaborations of structure may be present. When this vestibule is a cuticular structure without a surrounding muscular coat, it is conveniently termed a "buccal capsule." It may, however, be of the nature of a modified portion of the œsophagus itself, and be enclosed in part of the œsophageal musculature. In such cases it is convenient to refer to it as a "pharynx." An œsophagus is present in all Nematodes, and in the majority of them this organ, or at least its anterior portion, is provided with powerful muscular walls, surrounding a three-sided cuticular tube. This tube is a stomodæum—*i. e.*, is continuous with the external integument—and is moulted with the latter at each of the larval ecdyses. The muscles of the œsophagus are so arranged that when they contract the lumen of the organ is dilated. The œsophagus thus acts as a suction-pump for taking in liquid food. The

walls of the œsophagus commonly contain three glands, one dorsal and two subventral. The dorsal gland usually opens close to the mouth or within the vestibule, the others into the lumen of the œsophagus further back. Each of these glands, as a rule, contains a single nucleus. In exceptional cases, however, the glands may be multinucleate, or the three glands may be fused into a syncytial mass.

In some forms there are also cephalic glands, lying mainly free in the body-cavity and opening into the buccal cavity. In blood-sucking species such as the members of the family *Ancylostomidæ*, in which they are often highly developed, these glands appear to produce a hæmolytic or anticoagulant secretion. Similar functions are usually attributed to the œsophageal glands. It has also been suggested that in some cases their secretion has an "extra-intestinal" digestive action.

In some Nematodes there is at the posterior end of the œsophagus a muscular "bulb" containing a three-sided valvular structure. In others there may be a specialized, nearly solid, posterior portion of the œsophagus, of a non-muscular and possibly glandular structure, which it is convenient to distinguish as a "ventriculus." This ventriculus may give off one or more blind processes or appendices of similar histological appearance to itself. In the *Ascaridæ*, when a ventriculus is present, it usually contains the nuclei of the œsophageal glands. When, however, a single appendix is present, this contains the nucleus of the dorsal gland.

The œsophagus assumes unusual forms in certain groups. In the *TRICHINELLOIDEA*, for example, only its anterior portion is of the ordinary type, and for the greater part of its length it is a very narrow tube embedded, or partly embedded, eccentrically in a chain of peculiar cells (the "cell-body"). According to the observations of Thomas (1924), and of Chitwood (1930), however, even in its narrow portion the œsophageal tube still possesses a muscular wall and a triradiate lumen, and is not, as usually described, a mere cuticular tube forming the lumen of a series of "drain-pipe" cells. In adult *Mermithidæ* the œsophagus is represented by a slender cuticular tube, and has lost its connection posteriorly with the intestine, which is modified in this group into a solid "fat-body."

The œsophagus is connected posteriorly with the intestine, into which it commonly opens by means of a "valve" composed of three semicircular flaps. The intestine is, in almost all Nematodes, a straight or slightly sinuous tube, with simple or more or less folded walls. In rare cases it is considerably longer than the body, and therefore is disposed in loops. The walls of the intestine consist of a single layer of columnar

cells, whose inner ends frequently, if not always, have a "Stäbchensaum" or striated border. This border may assume the appearance of a bunch of cilia, and it has been thought by some observers that a ciliated epithelium actually occurs in the intestine of certain species. No movement of the supposed cilia, however, seems to have been observed. At the posterior end of the alimentary canal there is a "proctodæum" (*i. e.* an invagination of the external cuticle). This takes the form, in the female, of a relatively short rectum, and in the male of a cloaca, or common atrium into which open both the intestine and the ejaculatory duct, or terminal portion of the genital tube. The posterior opening of the alimentary canal is usually referred to as the anus in the female and as the cloacal aperture in the male. In the majority of Nematodes there is a postanal or postcloacal prolongation of the body, commonly called the tail. In the males of the STRONGYLOIDEA the bursa projects beyond the posterior end of the body, and there is no tail. In certain other forms the anus or cloacal aperture is terminal, so that in these again a tail is absent.

Caudal Glands.

In many free-living Nematodes the cavity of the tail contains three unicellular glands whose ducts open at the tip, often through a specially developed tube, which has been called by Bastian the "caudal sucker" and by Cobb the "spinneret." The function of these glands is to produce a sticky secretion, which may become solidified in the form of a thread on contact with water, and serves to attach the animal to solid objects. This habit of anchoring themselves by the tail is particularly common among species which live in streams or on the sea-shore. Some forms have been observed to progress somewhat after the manner of a "looper" caterpillar, by attaching themselves alternately by the mouth and tail to the substratum. In some parasitic genera (e. g. *Physaloptera*, and certain Heterakidæ and Oxyuridæ) a single caudal gland has been described, opening by a subterminal ventral pore.

Nervous System.

The nervous system is entirely enclosed in tissue belonging to the subcuticular layer. Its main centre is in the form of a ring of fibres (the "nerve-ring") surrounding the œsophagus and connected with a number of ganglia from which longitudinal nerve-cords are given off. Six such nerves run anteriorly to the sense-organs of the head. The number of nerve-cords given off posteriorly seems to be subject to some variation in different groups. In *Ascaris*, in which the nervous system is best known, there are eight posterior cords—a median ventral

(which is the largest), a median dorsal (the next in size), two lateral and four sublateral. These longitudinal nerves are connected at intervals by a number of asymmetrically-arranged transverse commissures. The median and sublateral nerves are probably mainly motor in function, the lateral nerves purely sensory. The latter send branches to the cervical papillæ, and are connected with the same ganglia as the two lateral anterior nerves, which supply the lateral cephalic sensory organs.

In the male there is a special development of the nervous system at the posterior end of the body, in connection with the copulatory apparatus and its associated sense-organs. The ventral nerve-cord is here connected with special ganglia and with a secondary nerve-ring surrounding, or partially surrounding, the cloaca. The lateral and sublateral nerve-cords of each side combine to form a large "bursal nerve," which is connected by a number of commissures with the ventral nerve and gives off a branch to each of the preanal and postanal papillæ.

A "sympathetic" nervous system has been described in certain forms (*e. g.* *Ascaris*, *Oxyuris*, and *Ancylostoma*). This is situated in the œsophagus, and consists of three longitudinal nerves lying in the three sectors of the œsophageal wall, connected by one or more transverse commissures, and giving off a network of fine fibres by which the œsophageal muscles are innervated.

The only sense-organs universally present are apparently of a tactile nature, and are in the form of papillæ (or, in many free-living forms, prominent bristle-like cuticular structures), situated chiefly towards the two extremities of the body and each supplied with a fine nerve-ending. The cephalic sense-organs are typically six in number, but may be more numerous and arranged in several rings. A pair of lateral sense-organs is almost invariably distinguishable by some peculiarity of structure from the rest. When papilla-like these lateral organs are usually larger than the others, which, in the majority of parasitic forms at least, are situated subdorsally and subventrally. Often, however, the lateral organs are pore-like rather than papilla-like, and in free-living genera they are commonly very highly specialized, and appear to consist essentially of tubular channels in the cuticle. These may assume a variety of forms, being sometimes straight, sometimes spiral, or of various intermediate types. These lateral cephalic organs of free-living Nematodes have been termed by Cobb the "amphids," to distinguish them from the other cephalic organs. The lateral organs of some parasitic forms, especially in their free-living larval stages, closely resemble them, and it may probably be assumed that the

lateral organs or lateral cephalic papillæ are holomogous throughout the group, though their function may not in all cases be identical.

In almost all parasitic Nematodes there is a pair of cervical papillæ (the "deirids" of Cobb), situated in or near the lateral lines in the œsophageal region. In some forms there is also a pair of lateral or subdorsal papillæ in the middle region of the body, called by Seurat the "intestinal papillæ." Exceptionally the cervical papillæ may be multiplied so as to form two extensive series, or there may be numerous papillæ arranged in more or less regular longitudinal rows throughout almost the whole length of the body. The tail, in both sexes, usually bears a pair of lateral sense-organs which are often rather pore-like than papilla-like, and have been called by Seurat the "caudal pores," and by Cobb the "phasmids." In addition to these, the caudal end of the male is usually provided with special papillæ, doubtless concerned in copulation. These vary greatly in number in different genera, but their number is more or less constant for a given species. They are mainly arranged in bilaterally symmetrical pairs and subventral or sublateral in position, but median ventral papillæ are also sometimes present in the vicinity of the cloacal aperture. In the males of the STRONGYLOIDEA the papillæ are limited to about six or seven pairs, and form the terminations of the rays of the bursa. Some of them may be situated on the inside and some on the outside of the bursal membrane. Frequently there is an additional pair of "prebursal" papillæ just in front of the bursa, or within the bursa just behind its attachment to the body. In the females of some Nematodes there is a pair of papillæ in the neighbourhood of the vulva.

In many free-living Nematodes "eye-spots," or ocelli, are present. These consist of masses of pigment within the body-cavity, in intimate connection with the œsophagus, and sometimes surmounted by a hyaline body acting as a lens. Such organs are unknown among the parasitic forms.

Excretory System.

In its simplest form the excretory apparatus consists of a single unicellular gland-like organ, termed by Cobb the "renette," usually situated in the œsophageal region, and connected with the exterior by a very narrow ventral duct. Such a simple excretory cell occurs not only in many free-living forms, but also in some of the more primitive parasitic genera, and even in the larvæ of some of the more highly specialized forms. In the majority of the latter, when adult, there is a pair of lateral excretory canals, embedded in or

closely connected with the lateral fields. These canals run throughout almost the entire length of the body, and are connected in the œsophageal region by a transverse ventral "bridge," to open into a narrow ventral duct leading to a small excretory pore. In some forms (*e. g.* some of the Oxyuridæ) there is a relatively large bladder-like expansion connected with the terminal excretory duct. In some cases the canal of one side (usually the left) is larger than that of the other, while in certain highly specialized forms (the Anisakinæ and some Anguillulinidæ) only one canal is normally developed. In the Anisakinæ the canal of the right side is more or less rudimentary or absent, while that of the left side is partly modified into a ribbon-like "gland," and the pore is situated very far forward, sometimes actually between the bases of the subventral lips. Both canals appear to be absent in the DIOCTOPHYMOIDEA and TRICHINELLOIDEA, and occasionally in other groups *

In certain Rhabditidæ additional lateral canals have been described in the posterior part of the body, opening by separate pores and sometimes having contractile ampullæ at their blind ends.

The protoplasmic covering of the whole canal system almost invariably contains only three nuclei. Two of these are connected with the terminal duct, while the third belongs to the two lateral canals, and, when these are paired, is situated asymmetrically (usually on the left side) near the opening. The excretory system appears to contain no cilia or flame-cells.

"Phagocytic organs," in the form either of giant cells or of branching plasmodia projecting from the lateral fields into the body-cavity, have been described in certain species, particularly among the Ascaridæ. These organs are said to act as filters for the removal of bacteria or other foreign particles from the fluid of the body-cavity.

Respiration.

Special circulatory and respiratory systems are entirely lacking in the Nematodes. The fluid of the body-cavity may possibly carry oxygen to the organs bathed in it, but the oxygen requirements of most parasitic species (or at least of those which live in the lumen of the intestine) appear to be almost negligible.

* A system of classification, based on the presence or absence of the excretory canals, was proposed by von Linstow (1905), but has not been generally adopted. He divided the Nematodes into three groups: Secernentes, having canals in the lateral fields; Resorbentes, having lateral fields without canals; and Pleuromyarii, in which lateral fields were absent.

Reproductive System.

With few exceptions, the sexes are separate among the Nematodes. Hermaphroditism and parthenogenesis, however, occur in certain genera. In the bisexual forms the males are almost invariably smaller and less numerous than the females. In many cases the difference in size is so pronounced that the males are liable to be overlooked in collecting, or mistaken for immature forms. The habits and habitats of the sexes, among parasitic species, may also be different. The female may live almost completely buried in the wall of an organ, such as the crop of a bird, while the male does not burrow, but wanders freely in the lumen.

The reproductive glands in both sexes are elongate and often much convoluted tubular or sac-like organs, closed at the free end and continuous at the other end with the ducts by which their products reach the exterior. In the males of some forms which may probably be regarded as primitive (chiefly among free-living genera) there is a pair of testes, running in opposite directions or parallel, but both connected with a common duct. In the majority of Nematodes, however, the testis is single. At the free end of the testis the cells destined to give rise to spermatozoa usually form a solid column. Towards the other end spermatocytes in successive stages of development are found, attached, in most families, to a central axis, or rhachis. The spermatozoa are only exceptionally elongate and tailed, like those of most other groups of animals. More commonly they are rounded, conical or rod-like cells, usually with some power of amoeboid movement. Specialized regions of the male duct may often be distinguished, and are sometimes referred to as a vas deferens, a seminal vesicle and an ejaculatory duct, the latter being a muscular posterior portion opening into the cloaca. A pair of "cement glands" is sometimes present, opening into the ejaculatory duct, and producing a substance which serves to attach the male firmly to the female during copulation. This "cement" often remains for some time after copulation as a kind of operculum over the vulva of the female, or even as a complete ring surrounding the body.

In connection with the cloaca there is usually a sheath, or a pair of such sheaths, containing a copulatory spicule or spicules. These are chitinous structures, varying greatly in form in different families and genera, and serving as intromittent organs, though not directly connected with the ejaculatory duct. Their chief function is probably that of "holdfasts" during copulation, or instruments for expanding the lumen of the vagina. In many cases they probably act as "gutters" for the conveyance of the sperm, while it has been suggested that they are also used as organs of excitation.

Their extrusion and retraction are brought about by special extensor and retractor muscles connected with the sheaths. In many genera the two spicules are equal in length and similar in form. They may, however, be of different shapes though of approximately equal length, while in many cases (particularly among the *FILARIOIDEA*) they show a more or less pronounced inequality in size and at the same time a marked dissimilarity in shape. As a rule in the *FILARIOIDEA* the left spicule is the longer. In the family *Heterakidæ*, on the other hand, when the spicules are unequal, the right spicule is usually longer than the left. In some families and genera there is only one spicule, or spicules are entirely lacking.

In the males of many genera there is, in addition to the spicules, another chitinous structure (or one or more pairs of such structures) formed as a thickening of the dorsal wall of the cloaca, and often appearing to serve as a guide for the spicules. This structure is usually called an "accessory piece" or "gubernaculum." A further chitinous supporting structure is sometimes developed in connection with the ventral wall of the cloaca, especially in the *STRONGYLOIDEA*, and has been named by Hall the "telamon." Unfortunately there has been a good deal of confusion in the application of these terms, and the structures for which different authors have used the same name are clearly not always homologous. It seems best, therefore, in most cases to retain the old term "accessory piece."

In some free-living forms there are modified preanal or postanal papillæ on the ventral surface of the male (usually in a median row), having frequently a more or less complex chitinous framework. These are probably clinging organs, assisting in copulation, and are commonly referred to as "supplementary organs." Of a somewhat similar nature is the preanal sucker or sucker-like organ met with in the *Heterakidæ* and *Kathlaniidæ*, and occasionally in other groups of parasitic Nematodes. This is a depression in the cuticle supplied with special muscles, and provided, in the *Heterakinæ*, with a well-defined ring-like supporting structure of thickened cuticle.

The genital tubes of the female are, in the majority of cases, paired. Generally speaking, there is a muscular vagina, leading into an undivided portion (often called the "common trunk") of the uterus, and the latter divides to form two branches, each ending in a separate ovary. In what may be considered the more primitive types, the vulva (which is always ventral) is situated in the middle region of the body, and the two genital tubes, communicating with it by a short vagina, extend towards the opposite ends of the body. The position of the vulva, however, has been shifted, in various

groups, towards one or other of the extremities, and this has led to many modifications in the arrangement of the genital tubes. It is, of course, obvious that a number of arrangements are possible. The two tubes may, as already described, diverge, more or less at right angles to the vagina, in opposite directions. In this case they are commonly spoken of as being "opposed," or by Railliet and some other authors as "divergent." On the other hand, they may be connected with the vagina in such a way as to run, parallel to each other, towards the anterior or posterior end of the body. In this case they are usually said to be "parallel."* Each of these two main types of arrangement is susceptible of various modifications, for which Seurat has elaborated a system of terminology. The opposed type he names "amphidelphy," and forms in which it occurs are called "amphidelphs." The condition in which the genital tubes are parallel is termed "opisthodelphy" or "prodelphy," according to whether the tubes run backward or forward from their junction with the vagina. Seurat considers that "prodelphy" is the primitive condition, and that it has been preserved in such forms as *Heterodera* and the majority of Oxyuridæ. In certain other groups, in his view, "prodelphy" has been secondarily acquired (presumably by way of "amphidelphy"). Whatever their arrangement, the female genital tubes, like those of the male, show a differentiation into various regions. At the distal end of each is an ovary, which varies in form from a relatively short cone to an enormously long and coiled thread. In the ovary the oocytes are formed in the same manner as the spermatozoa in the testis. There is a distal germinative zone in which the cells are packed together in a solid mass, or in a single row, and a proximal zone of growth in which they are usually attached for some time to a central rhachis. Passing further along the ovarian tube, the germinal cells become free. Ultimately they pass through an oviduct (often of narrower calibre) into the uterine branch. At the distal end of this there is sometimes a specialized receptaculum seminis, in passing through which the ova are fertilized. In any case, fertilization takes place in the uterus, and after this, as a rule, a firm shell of a chitinous substance is secreted round the egg.

The wall of the ovary is composed of an outer membrane (tunica propria) and an epithelium of elongate, spindle-shaped cells. The walls of the oviduct and uterus are provided, in addition, with a layer of transverse muscle-fibres between the outer membrane and the lining epithelium.

* The term "convergent," sometimes used in this sense, seems unfortunate and liable to be misleading.

The lining of the uterus sometimes consists of very large, elongate, flattened cells with several nuclei. The uterine branches, and their ovaries, are occasionally more than two in number (usually a multiple of two), and occasionally numerous, in forms in which they are parallel.

The displacement of the female genital aperture towards either end of the body, in forms in which the genital tubes were presumably originally opposed, has led in some cases to the great reduction or complete disappearance of one of the tubes. This is most frequent where the vulva is near the posterior end. The posterior uterine branch sometimes remains in a vestigial condition as a short egg-reservoir, without an ovary. In two small orders of parasitic Nematodes, the TRICHINELLOIDEA and DIOCTOPHYMOIDEA, the genital tube is invariably single in both sexes. In the former the female is "opisthodelphous," in the latter "prodelphous." In both groups the germinative area of the testis or ovary extends, according to Rauther, along its whole length as a tube or as a strip along one side, and there is no rhachis. These peculiarities are considered by Rauther of such importance that he places the forms possessing them in a special group, which he names HOLOGONIA, while all the rest of the Nematodes (in which the gonads have a terminal germinative zone) are classed together by him as TELOGONIA.

The vagina, in its simplest form, is a cylindrical duct with a cuticular lining which is continuous with the external cuticle of the body, and having a muscular coat consisting of one or more layers of circular fibres and an inner layer of longitudinal fibres. It is of very variable length in different groups, and frequently becomes very complex in structure. The term "ovejector" has been applied by Seurat to the whole of the organ here called the vagina. This name, however, is better restricted to certain special structures often connected with it, which appear to control the passage of eggs, or to prevent them from returning in the direction of the uterus. There may be only one such ovejector, situated near the vulva and taking the form of a specially modified portion of the muscular duct, as in many FILARIOIDEA. In many of the STRONGYLOIDEA, however, there are paired ovejectors connecting the two uterine branches with the unpaired portion of the vagina. These generally consist of a glandular portion, nearest to the unpaired duct, and a muscular portion or sphincter.

DEVELOPMENT.

Nematodes may be oviparous (producing eggs which hatch some time after deposition), ovoviviparous (producing eggs which may or may not have firm shells, and which hatch

immediately after deposition) or viviparous (producing eggs which hatch while still contained in the uterus). The majority both of free-living and parasitic forms are oviparous. In the former and in the more primitive parasitic genera the number of eggs produced by an individual female is usually relatively small, and their size relatively large. In the more highly specialized of the parasitic forms, however, a very much larger number of eggs is usually produced, and these are very much smaller relatively to the size of the parent worm.

The eggs are usually of a regular ovoid shape, but show much variation in different families, being sometimes nearly cylindrical, sometimes barrel-shaped, sometimes subglobular or quite spherical, and occasionally lenticular. Among the Oxyuridæ they often have one convex and one more or less flattened surface, and may even sometimes be described as "banana-shaped." In the eggs of certain families and genera polar plugs or opercula are present at one or both ends of the shell, and in other cases there may be at one or both poles a filament or a bunch of filaments. The function of such filaments is probably in some cases to keep the eggs together in clumps, so as to ensure multiple infection of the host-animal which swallows them; in others they are known to serve for the attachment of the eggs to vegetation. The surface of the egg-shell may be smooth or variously sculptured or ornamented. The origin of the egg-shell has not yet been satisfactorily explained. Immediately after fertilization the ovum secretes round itself a thin vitelline membrane. Some authorities think that the formation of the more or less stout, chitinoid shell is merely a continuation of this process, while others believe that the shell is secreted by the walls of the uterus. While an additional coat is apparently, in some species, deposited on the shell by "varnish glands" situated in the vagina, it is doubtful whether glandular cells capable of secreting the shell-substance exist in the uterus.

In ovoviviparous and viviparous forms the egg-shell is usually represented by a thin, elastic membrane, which may elongate and adapt itself to the shape of the developing embryo.

It is not intended here to deal with the embryology of the Nematodes, the details of which may be found in general text-books of invertebrate zoology and embryology. It will be sufficient to state that Nematodes do not undergo any pronounced metamorphosis in the course of their development. A young Nematode, at birth, or on hatching from the egg, has the typical external form of the group. It may, in fact, be said that at this early stage the larva is often a more typical Nematode than its parents, for considerable modifications in shape may occur in the adult.

The development of the embryo within the egg is not, in the majority of forms, completed until some time after oviposition, the contents of the eggs, when laid, being either in an unsegmented condition or in the early stages of segmentation. In such cases the eggs usually reach the exterior with the fæces of the host, and a period of time varying from a few days to several weeks, and partly dependent upon conditions of temperature and moisture, must elapse before the embryos are ready to hatch. In some of the more highly specialized parasitic forms an embryo is already fully developed in the egg before oviposition. These are commonly forms requiring an intermediate host for the development of the larva, and their eggs do not, as a rule, hatch unless first ingested by a suitable host.

The young Nematode, on leaving the egg, is usually what is termed a "first-stage larva." The larval period is divided into a succession of stages by moults or ecdyses, of which there are usually four. At each moult the outer cuticle becomes detached, together with the linings of the mouth, œsophagus and rectum. As each new cuticle is formed beneath the old one about to be moulted, various changes may occur in the structure of the mouth and other cuticular parts of the larva, while the gradual differentiation and development of its internal organs are also proceeding. The second of these moults is often of special importance in the life of a Nematode. If a parasitic form, it is at this point that it reaches the "infective" stage, and, ceasing to live and feed like a free-living form, awaits the opportunity of entering a host. This infective stage is, in certain genera, reached before hatching from the egg. Generally speaking, however, it follows two periods of active feeding and growth, separated by the first moult. The nature of the food taken by larval Nematodes has not yet been very fully investigated, but there is evidence that in many cases it consists principally of bacteria. At all events, cultures of *Bacillus coli* have been found to provide very suitable food for the larvæ of several kinds of STRONGYLOIDEA.

Frequently the second cuticle is not shed at once, but is retained as an additional protective envelope or sheath which enables the larva to withstand many adverse conditions. The third-stage larva, in its sheath, may be able to withstand apparent desiccation for long periods, and to "come to life" again when exposed to moisture. This extra power of resistance in the third-stage larva is extremely useful to many parasitic forms, enabling them to survive on vegetation or in comparatively dry soil until an opportunity occurs of invading a host. It also assists them in the dangerous passage through the stomach of the host, by protecting them against the action

of the gastric secretion. In the safer alkaline medium of the intestinal contents the old second cuticle is usually promptly shed.

The genital organs, represented in the earlier stages by a small mass of cells ("genital rudiment"), undergo little development, as a rule, until the fourth stage. The genital rudiment, in both sexes, then becomes elongated and takes on the form of a tube, or paired tubes, gradually acquiring the disposition and differentiation into various regions found in the adult. The sexes are thus often distinguishable during the fourth larval stage. The rudiments of the accessory sexual organs of the male (spicules and accessory piece) are usually laid down towards the end of this stage as solid masses of cells. After the fourth moult the development of the whole of the genital organs proceeds rapidly, and the worms quickly assume the character and functions of adults.

BIONOMICS AND LIFE-HISTORY.

A very large number of species of Nematodes are free-living. Broadly speaking, these comprise forms inhabiting the soil, fresh water, and the sea or its shore, and are mostly of very small size. The terricolous and freshwater forms include many which live in decomposing organic matter of the most varied kinds, and others which show various degrees of association with other organisms, both vegetable and animal, as temporary parasites or as commensals. Many, such as the vinegar-eel (*Anguillula aceti*), probably subsist chiefly on bacteria. Aquatic species seem to feed mainly on algæ and diatoms. The Anguillulinidæ attack the roots or other parts of plants by means of a specially developed piercing organ or stylet. Some species only pierce the outer cortex, presumably for the purpose of feeding on the juices. Others penetrate more or less deeply into the tissues, while some are responsible for the production of galls and other deformations of the plant. Some free-living forms, notably the members of the genus *Mononchus*, are carnivorous, and their prey often consists of other Nematodes. Many species live in more or less close association with other invertebrate animals, as commensals—in the cavities of sponges and corals, for example, or in the galleries formed by the larvæ of wood-boring beetles. Some forms appear to make use of insects as means of transport, being often found, for example, under the wing-cases of beetles. A remarkable case of apparent commensalism with a vertebrate is that of *Odontobius ceti*, which occurs in colonies on the surface of the baleen-plates in the mouths of whales.

From such associations it is an easy step to genuine parasitism, and of this all degrees may be found. With the development

of the parasitic habit, many Nematodes seem to have assumed the power of growing to a much larger size, while the parasitic forms also show a much greater range of variety in structure and adaptive specialization than their free-living relatives. The most striking specialization has taken place in the direction of increased fertility, as is often the case with internal parasites. It has been estimated that a single hookworm may produce as many as 9,000 eggs a day, and a single *Ascaris* between 230,000 and 250,000 a day. This high rate of reproduction, of course, tends to compensate for the high rate of mortality in creatures which depend so much upon chance for their entry into suitable hosts. Of the "degeneration" which is commonly said to result from parasitic habits there is little trace among the Nematodes, beyond the loss of "eyes" and prominent sensory bristles, which would be of no service to them in the interior of the host. Such organs, however, are not always possessed by the free-living forms,

The Nematode parasites of invertebrates fall into several categories, according to their different types of life-history. Some (such as *Allantonema*, *Sphærulearia*) have an adult stage in the body-cavity of an invertebrate host, but pass the rest of their life-cycle (which may include a bisexual generation) as free-living organisms. Others, such as the Mermithidæ, pass only part of their larval period as parasites in the body-cavity, the adults being free-living. Others again (chiefly Oxyuridæ), which inhabit the alimentary canal of such creatures as centipedes, cockroaches and beetles, are parasitic throughout all their stages, only the eggs having any existence outside the host. Lastly, there is a large assemblage of forms whose larvæ are found encysted in invertebrates, and cannot develop into adults until ingested by a vertebrate.

The Nematode parasites of vertebrates exhibit the greatest diversity in specialization and adaptation to their hosts, in habitat, in mode of life and in developmental history. The most primitive types, probably, are those which have a direct development, without the intervention of an intermediate host. These are forms such as the Oxyuridæ and Heterakidæ, some Ascaridæ and most of the STRONGYLOIDEA. They inhabit the lumen of the alimentary canal, and many of them feed on partly digested organic matter, on mucus, or on bacteria and Protozoa, being thus comparatively harmless so far as the host is concerned. Some of them, however, have developed the habit of clinging by the mouth to the mucous membrane, and this has led in some cases to more injurious activities, through the partial destruction of the membrane. Many of the STRONGYLOIDEA, for example, ingest cellular elements from the mucosa itself, or feed on blood escaping from damaged capillaries. There is evidence that some of

them produce histolytic and anticoagulant secretions, and that external digestion plays a part in their feeding processes.

Many forms, instead of living free in the lumen, or merely attaching themselves to the walls of the alimentary canal, burrow into glands or excavate galleries in or beneath the lining, or even cause the production of tumours in the thickness of the walls.

Apart from the alimentary canal, there is hardly an organ or tissue of the body that may not be the habitat of some kind of Nematode. Thus the trachea, bronchi, bronchioles and lung tissue may be invaded by "lungworms," the heart and blood-vessels by Filariids and other forms, the serous cavities, peritoneal, subcutaneous and intermuscular connective tissue, and the urinogenital system, by worms belonging to various families. Adult worms rarely occur in situations from which their eggs or larvæ have no means of escape to the exterior, and when they do so occur must be regarded as "erratic" parasites. Larval forms, however, usually in an encysted condition, may be found in almost any situation.

In the direct type of life-history the infection of the host may take place either by means of eggs or by means of larvæ. In the former case a period of exposure in the open (usually a matter of some weeks) is necessary for the development of the contained embryos to the infective stage. The eggs, on being swallowed by the host, generally do not hatch in the acid environment of the stomach, but do so on reaching the upper part of the intestine, where they meet with an alkaline medium. In a comparatively small number of cases the larvæ remain within the intestine, undergoing their remaining moults there and growing to maturity. The larvæ of some species burrow temporarily into the mucosa or submucosa, and may form cysts there, to emerge later into the lumen.

Probably in the majority of cases, however, a much more complex course is followed between the hatching of the larvæ and their arrival in their final habitat. After hatching, the larvæ proceed at once to burrow into the walls of the intestine and penetrate into the small mesenteric veins or into lymphatic vessels. Thence they are usually carried by the blood-stream of the portal system to the liver, on again to the heart, and by way of the pulmonary arteries to the lungs. Forms which live in the blood-vessels may, of course, proceed no further in their migration. In other cases the larvæ ultimately rupture the capillary vessels in the lungs and escape into the alveoli and bronchioles. Should the habitat of the species be the air-passages, the course of migration may stop here; but many intestinal parasites follow the same route, and continue it further. Passing up the bronchi and trachea, they enter the mouth and are swallowed a second time. Some growth

and development have usually taken place during the passage through the lungs, and the larvæ now remain in the alimentary canal and, having undergone the final moult, become sexually mature.

In the case of placental mammals, the migration by way of the blood-stream involves the possibility of prenatal infection, and this occurs, for example, in dogs and cats, should the female, a few days before the birth of the young, have ingested the eggs of Ascarids or become infected with the larvæ of hookworms.

As has already been mentioned, infection may take place by means of larvæ. The infective (third stage) larvæ may be ingested passively by the mouth, as is the case, for example, with many of the STRONGYLOIDEA parasitic in herbivorous animals. The larvæ of these forms frequently have the habit of climbing up on to the grass when it is wet with dew or rain. The infective larvæ of certain other forms, such as the hookworms and *Strongyloides*, have the power of actively penetrating the skin of the host. Thus infection may take place through contact with soil which contains the larvæ. After entering the skin, the larvæ find their way into the blood-stream, and follow a course of migration within the body similar to that which has been described above.

A quite different type of life-history is that in which development is indirect, and the larvæ pass through one or more intermediate hosts before entering the definitive host. As has already been mentioned, encysted larval forms are very common among the tissues of both invertebrates and vertebrates. So far as is known, the whole of the family Spiruridæ (using this term in a wide sense, corresponding with the superfamily Spiruroidea of many authors), have a life-history of this kind, their normal first hosts being invertebrates. The eggs are swallowed by the invertebrate host, and the larvæ hatching from them in its alimentary canal make their way into its body-cavity or connective tissue, where they generally become surrounded by a capsule or cyst derived from the host's tissues. They undergo the first two moults, and await, as third-stage larvæ, the chance of the first host being devoured by the second or definitive host. In many cases the animal to which the first host is most likely to fall a prey is a vertebrate to which the parasite is well adapted, and in which it can complete its development to maturity. Sometimes, however, the normal second host is a herbivorous animal, and in this case it seems that the fortunes of the parasite must depend upon the chance of the first host being ingested accidentally by the second with the vegetation upon which it feeds. Even when the normal second host is a carnivorous animal, it frequently happens that the larva, contained in its

final host, is ingested by some other vertebrate in which it is incapable of attaining maturity. This may often prove fatal to the parasite, but is not necessarily so, since the larvæ of some forms, such as *Spirocerca*, are capable of becoming re-encysted in various kinds of small vertebrates. The latter may thus act as second intermediate hosts, and may, in their turn, fall victims to a suitable final host.

Certain other groups, such as the subfamily Anisakinæ of the Ascaridæ, and the family Dioctophymidæ, appear to have a life-history very similar to that of the Spiruridæ. Their encysted larvæ occur chiefly in fishes or batrachians, and their adults in animals which prey upon these hosts. Some of them appear also to make use of an invertebrate as first intermediate host, but it is not yet known whether this is the general rule.

Finally, the highly specialized life-history characteristic of the Filariidæ must be mentioned. In this family the intermediate hosts, or vectors, are usually mosquitoes or other blood-sucking flies. The adults live in the connective tissue, blood-vessels, lymphatic system or serous cavities of vertebrates, and the females are viviparous or ovoviviparous. The first-stage larvæ, or microfilaria, find their way into the blood-stream or into the lymphatics, whence they may be taken up by the vector in the act of suction. Unless so taken up by a suitable insect, they are unable to develop beyond the first stage. Within the insect they usually migrate from the stomach to the thoracic muscles, and here continue their development, undergo at least one moult, and may grow to many times their original size. Ultimately they migrate towards the head of the insect, and many of them collect in the labium. When the insect bites they travel down this organ and emerge from it on to the skin of the animal bitten. They then at once proceed to penetrate the skin, enter the lymphatics or blood-vessels, and are thus carried to the site in which they are able to develop to maturity.

THE RELATIONSHIPS BETWEEN PARASITIC NEMATODES AND THEIR HOSTS.

There is a common belief that all parasites, and more especially internal parasites, are injurious to the health of their hosts. Though this idea may contain an element of truth, it certainly requires much qualification. Parasitic worms of one kind or another occur in nature in almost every species of vertebrate, and often in almost every individual of the species. They are frequently present in large numbers without producing any visible signs of disease or discomfort. All the available evidence points to the conclusion that internal

parasites are a normal feature of the life of most animals, and that in the process of evolution certain parasites and certain hosts have become mutually adapted to each other. There clearly exists between the parasite and its host a certain state of equilibrium, and so long as this is not disturbed by any abnormal circumstances the well-being of the host is not, as a rule, seriously affected. When, as is often the case with domestic animals, diseased conditions do make their appearance as a result of parasitic infection, this is generally due to some interference with the normal conditions of nature. Most of the parasitic diseases of farm stock, for which Nematodes are often responsible, are directly due to overcrowding, insanitary housing, malnutrition and the lack of adequate provision for frequent changes of pasture. In consequence of these conditions abnormally heavy infections are acquired, the resistance of the hosts is lowered, and their health may be very seriously affected by parasites which, appear comparatively innocuous when present in smaller numbers, or when they occur in closely-related wild animals.

There are a number of ways in which internal parasites may do damage to their hosts. Broadly speaking, the kind of damage done falls into two categories—mechanical and physiological. Mechanical damage to the tissues may be done by larval Nematodes in the course of their migration, and also, in exceptional cases, by adult forms which wander about the body. Occasionally the ducts of important organs may be blocked; *Ascaris*, for example, may block the bile-duct, with more or less serious results. Sometimes skin-penetrating larvæ, or worms burrowing and migrating among the tissues, may introduce, or pave the way for, bacteria and other pathogenic organisms, and thus indirectly cause disease.

A striking example of the effects that may follow upon what might be called "parasitic starvation" is furnished by the Mermithidæ. The larvæ of these worms, which live in the body-cavity of insects, and there grow to a very large size, appear to feed by the absorption of the body-fluid (blood) of their hosts. In so doing they deprive the organs of the insect of their proper nourishment, with the result that the fat-body of an infested insect is often found to be almost non-existent. Further, in many cases the development of the genital glands is arrested and the insect rendered sterile. This physiological castration may even show itself in changes in the external appearance of the insect. Among ants, for example, individuals infested with *Mermis* are sometimes deprived of the power of flight, and changes in the outward appearance of infested males, females and workers have led to such individuals being distinguished as "mermithaners," "mermithogynes" and "mermithergates."

A clear distinction between mechanical and physiological effects is not always easy to make in the case of parasites of the alimentary canal. The mere abstraction by the parasites of a certain amount of partially-digested food may have little or no appreciable ill-effect. If, however, the parasites feed at the expense of the host's blood, or upon the cellular elements of its tissues, their attacks may produce lesions which are primarily of a mechanical nature, but lead to more or less profound physiological disturbances. To take an example, human infestation with hookworms may lead not only to ulceration of the intestinal walls, but to a severe form of anæmia. Further, especially in children and adolescents, it may have still more far-reaching effects, leading to a general arrest of development, both physical and mental. Here, therefore, it seems almost necessary to assume that something more than mere mechanical injury is involved. There is, in fact, a growing mass of evidence to the effect that many parasitic worms produce toxic substances which may, in given circumstances, be absorbed into the blood of the host and affect its physiological constitution. How and why such toxins are produced by the parasites are questions which have not yet been satisfactorily answered. We know, however, that worms, in the same way as bacteria and other micro-organisms, can act as antigens and cause the production of antibodies in the blood of the host. Not only can the presence of parasites often be detected by appropriate complement-fixation and other serological tests, but a light infection with a given parasite is often found to confer a certain degree of immunity against subsequent infection with the same parasite.

It has already been mentioned that histolytic and anti-coagulant secretions appear to be produced by the oesophageal or cephalic glands of some Nematodes. Many species which simply attach themselves by the mouth seem to produce a kind of liquefaction of the host's tissues near the point of attachment, and apparently feed on them in this predigested form. Others also, such as *Spirocerca*, which cause the formation of nodules or tumours, apparently feed on an amorphous mass produced by the liquefaction of the interior of these growths.

The host's tissues frequently behave towards an invading parasite in the same way as towards any other foreign body. That is to say, a local inflammatory reaction is set up, leucocytes (mainly eosinophil in the case of a worm parasite) swarm round the offending object, and by the organization of these cells a capsule of fibrous tissue is formed. A "worm-nodule" thus usually consists of a more or less hard fibrous capsule surrounding a caseated mass in the centre of which lies the

parasite. If the parasite dies, and sometimes even before its death, the mass usually becomes calcified, and this process ultimately involves the parasite itself.

The inflammation set up by tissue-invading Nematodes does not, however, always lead to the formation of nodules. It may lead to hypertrophy of the invaded tissue, and to more or less marked changes in its nature. The new growth of tissue may even become malignant, and this brings us to the vexed question of the part played by Nematodes (as well as other worm parasites) in the causation of cancer. This is not the place for a discussion of this question, and it will be sufficient to say that, while suspicion attaches to a number of species of Nematodes, the evidence against most of them is still incomplete. The two best-authenticated cases are *Gongylonema neoplasticum* and *Capillaria gastrica*, both parasites of the cardiac portion of the stomach of rats, and both apparently capable, under natural and experimental conditions, of inducing carcinoma. But even in these cases we are as yet ignorant of the other factors that may be involved, and it cannot be assumed that the worms are directly responsible for the formation of the new growths.

SPECIFICITY.

The limitation of a given parasite to a certain kind of host, or to certain closely-related hosts, is a phenomenon met with in varying degrees in all groups of parasites, and usually called specificity. Among the parasitic Nematodes some genera and families show a very marked degree of specificity, while others have a wide range of hosts which may not be at all closely related. There is a tendency, as might be expected on the hypothesis of parallel evolution, for highly-specialized hosts to harbour parasites which are themselves highly specialized and do not occur in other hosts. In elephants, for example, we find a whole series of genera of Nematodes which are peculiar to these animals. Representative species of the genera frequently occur in both the Indian and the African elephants, but not identical species. From this it seems reasonable to conclude that the common ancestor of the two types of elephant must have harboured a series of Nematodes which were already diverging from those found in other animals, and which were the ancestors of the forms existing to-day. The gradual divergence of the hosts must have been accompanied by a similar divergence of the parasites. In such a case as this it seems evident that the predominant factor in determining the range of the parasites must be the blood-relationship of the hosts.

Such clear cases of specificity are, however, comparatively rare among Nematodes. While it is true that few genera

occur in hosts belonging to different orders of vertebrates, and still fewer in hosts belonging to different classes, nevertheless instances do occur in which the habits of the hosts seem to have had a greater influence on the distribution of the parasites than their relationships. Among the Ascaridæ, for instance, species of certain genera such as *Porrocæcum* and *Contracæcum*, whose larvæ occur chiefly in fishes, are found as adults in fish-eating animals of all classes (mammals, birds, reptiles and fishes).

In a discussion of this subject published some years ago *, the writer brought forward evidence which seemed to show that Nematodes having a direct life-history are, on the whole, more strictly limited as to their definitive hosts than those whose life-history is indirect. As a tentative explanation of this it was pointed out that the larvæ of the former enter the final host at an earlier stage of development than those of the latter, and are therefore, perhaps, less tolerant of hosts to which they are not perfectly adapted.

Baer †, who has recently attempted to analyse the distribution of the genera of Nematodes among the principal orders of vertebrates, finds that the figures form an ascending scale from the lowest class (fishes) to the highest (mammals). While little significance, perhaps, can be attached to this result (the analysis takes no account, for instance, of the relative numbers of species, genera and families in the host-groups), it lends some support to the view that as the hosts became more highly specialized, so did their Nematode parasites, thus necessitating the formation of more numerous generic concepts.

TECHNIQUE.

It may be useful to describe some simple methods of collecting and preserving Nematodes, and of preparing them for microscopic examination.

(a) *Collecting.*

Free-living Forms.

Some of the species living in soil or fresh water, or in sand and among seaweeds on the sea-shore, are large enough to be easily seen. Mud, sand, weeds and the roots of plants may be washed in water, and the washings examined in a flat dish. Sometimes it is useful to pass the washings first through a wire screen in order to remove the coarser particles. The dish in which they are to be examined should preferably be of glass, so that it may be examined over a dark or a light

* Journ. Linn. Soc. Lond., Zool. xxxvi, p. 13 (1924).

† Bull. Soc. Neuchâtel. Sci. Nat. lviii, p. 57 (1934).

background, or by transmitted light, as may be required, and only a shallow depth of water should be examined at a time.

The majority of the free-living forms, however, are so small that a lens, or preferably a binocular dissecting microscope, must be employed in order to find them. The worms may be picked out with a fine glass pipette or with a needle mounted in a handle. For very small specimens a mounted bristle or, better still, a flat barb from a feather is more useful than the finest needle.

When it is desired to collect small specimens in large numbers, the material may be sifted through filters of increasingly fine-meshed wire or muslin. When the worms are comparatively free from coarse material, they should be washed off into a tall vessel of water, in which the heavier particles will rapidly sink, and since the worms, being lighter, will settle more slowly, they may be quickly decanted off into another vessel. The worms in their turn may now be allowed to settle, and the supernatant muddy water poured off. The "Baermann apparatus" may also be used for extracting Nematodes from soil and other materials. The method is as follows:—A funnel, having attached to its neck a short piece of rubber tubing, closed by a clamp, is supported on a stand, and partly filled with warm water (about 40°–42° C., or 104°–108° F.). A portion of the material, tied up in muslin*, is then placed in the funnel, so that the water is in contact with its lower surface. The warmth will stimulate the worms, which will migrate out into the water, and in the course of an hour or so will gravitate down the neck of the funnel, and may be drawn off into a centrifuge-tube or other vessel.

Parasitic Forms.

When dissecting an animal in order to search for internal parasites, as thorough an examination as possible should be made not only of the alimentary canal, but of the whole body. Intestinal worms should always be collected and preserved as soon as possible after the death of the host, as the process of decomposition may cause them to deteriorate very rapidly.

When parasites are found in nodules or tumours in the walls of the alimentary canal, or embedded in the tissues, it is desirable to make an attempt to extract them while fresh, as this may become very difficult after the tissues have been hardened by preservatives. Some of the nodules should, however, be cut out and preserved intact, with a portion of the surrounding tissue.

* If the muslin is new, the dressing should first be removed from it by soaking it in water and wringing it out.

In order to search for intestinal parasites, the gut of the host should be removed and slit up with scissors (preferably blunt-ended, to avoid damage to the worms), and after the removal of the gross contents and any obvious parasites, the mucous membrane should be washed with a 1 per cent. solution of common salt, and carefully examined for the less conspicuous forms that may be adhering to it. If salt solution is not available, plain water may be used, but it is liable to damage delicate species if they are left in it for more than a few minutes.

If the host be a small animal, the whole of the gut may be opened in a dish of salt solution or water, or opened and then shaken up in a partly filled jar, but care should be taken, if possible, to note the region of the gut in which parasites occur.

Some small worms are not easily detected unless the lining of the part under examination (*e. g.* the cæca of a bird) be scraped with an instrument such as the back of a knife, and the scrapings shaken up in the washing fluid. This may then be turned out, a little at a time, into a flat dish, and the worms picked out as described above. A better plan in some cases is to use a tall jar, and allow the mixture to stand in it for a few minutes. The worms will sink to the bottom, and most of the dirty fluid may be gently poured off. Clean fluid is then added, and the process repeated until the worms are comparatively free from other matter.

Small worms may be collected by this method of sedimentation from the stomach and intestines of large animals. It is best to deal with the stomach, small intestine and large intestine separately. The intestine should be freed from the mesentery, straightened out and opened. Its gross contents having first been washed and sedimented, parasites still adhering to the lining may be obtained by scraping the wall or stripping it between the fingers, and washing the material thus collected. The Baermann apparatus may be used, as described above for free-living forms, for extracting small Nematodes from faecal matter, or even from chopped-up lung, liver and other tissues.

All Nematodes inhabiting the alimentary canal should be thoroughly washed before being preserved, in order to free them from mucus and other matter. This is best done by shaking them up in a tube or jar of salt solution or water. Vigorous shaking will not, as a rule, damage the specimens, and will often remove mucus and débris from the mouth-cavity or bursa, which it may be very difficult to clean after preservation. Some long, slender and active species tend to become much tangled during the washing process, and to prevent this the individuals should be kept apart and killed as quickly as possible.

(b) *Preservation.*

Owing to the resistant nature of the cuticle of most Nematodes, hot fluids are almost indispensable for preserving them, if good specimens are to be obtained. There are, however, certain forms, such as the tissue-inhabiting Filariids, for which cold fluids appear to be better, as heat is liable to cause them to burst. Generally speaking, elaborate fixatives are unnecessary, and fluids containing corrosive sublimate should be avoided for Nematodes. The most useful fluids are formalin (3–5 per cent.) and alcohol (70–80 per cent.). To the latter, for small forms, it is often useful to add glycerine in the proportion of about 5 per cent.

The larger kinds of free-living Nematodes may be killed by immersion in hot or cold formalin, or in hot alcohol or glycerine-alcohol. For *Mermis* the writer has found cold 5 per cent. formalin very successful. After a very short immersion in this (for a few seconds only), and before they have become stiff, these worms should be straightened by gently drawing them between the fingers, or by laying them on a glass plate and stroking them with two camel-hair brushes dipped in the formalin. Once they have become stiff they may be permanently stored in formalin.

The most convenient method of killing small free-living forms is to apply heat to the water containing them. If only a few specimens have to be dealt with, they may be placed in a drop of water on a glass slide, and the slide then heated over a small flame, or by any other convenient method. When straightened out and immobile, the worms may be transferred to formalin. If a large number of such small worms are to be killed, a very convenient method is to place them in a small quantity of water in a test-tube or centrifuge-tube, and apply heat to the tube. The worms may then be allowed to settle to the bottom, or be centrifuged down, as much as possible of the water may be poured off, and formalin may be added. If it is desired to use hot alcohol or glycerine-alcohol as the killing fluid, the worms may be placed in a vessel of water. As much as possible of the water is then drained off, and the hot fluid poured over the worms. When this has been allowed to cool, the specimens should be stored in a fresh supply of the same fluid.

For killing parasitic Nematodes hot water is not recommended, as it is liable to cause excessive stretching of the cuticle. Hot alcohol or glycerine-alcohol, and hot formalin, will give good results in most cases. The fluid should be kept steaming, but not quite boiling, a temperature of 70°–80° C. (or roughly 160°–180° F.) being high enough. If of moderate size, the worms, after being washed, should be dropped separately into the fluid. Enamelled iron vessels, of a width

sufficient to allow the specimens to straighten out, are very suitable containers in which to heat the fixatives. It should, of course, be remembered that the vapour of alcohol is inflammable. The risk of fire will be lessened if the vessel used be not too shallow. After the fluid has been allowed to cool, the specimens should be stored in fresh fluid of the same kind.

If the worms are small and numerous, it may be easier, after draining off as much as possible of the washing fluid, to pour the hot fixative over them. When cool, the whole may be poured into a tube or bottle and allowed to settle. The used fluid should then be replaced by fresh.

(c) *Preparation for Microscopic Examination.*

Here again elaborate methods, as a rule, possess no advantage over simple procedures. Staining is, in most cases, both unsatisfactory and unnecessary. For all ordinary purposes simple clearing is sufficient to enable the structure of the worms to be made out. The most useful clearing agents are, in the writer's experience, glycerine, lactophenol and beechwood creosote. Which of these reagents should be used depends partly on the size of the specimens and partly on the method by which they have been preserved. Generally speaking, for small, naturally translucent forms glycerine will be found to give sufficient transparency. If a slightly higher refractive index is required, lactophenol is often useful, while for relatively stout, opaque forms creosote is admirable. Provided that certain precautions be observed, none of these reagents will injure the specimens seriously, even if they are repeatedly subjected to them.

Glycerine.—Specimens which have been preserved in the glycerine-alcohol mixture may be left in a shallow dish (such as a "solid watch-glass") of this fluid, and the alcohol and water allowed to evaporate. It is undesirable to hasten this process by heat, as too rapid concentration of the glycerine will cause serious shrinkage. The best method is to allow the evaporation to take place at room temperature. After two or three days the specimens will be in almost pure glycerine, and can be transferred to pure glycerine with safety.

It is, of course, possible to transfer specimens which have been preserved in formalin to glycerine-alcohol or any other alcoholic medium, provided that the change be gradual. This may be accomplished by passing them through alcohols of gradually increasing strength—30, 50 and 70 per cent. being usually sufficient.

Small specimens may be mounted permanently in glycerine. The principal difficulty is to cement the edges of the cover-glass securely enough to prevent leakage. After a little

practice it will be found possible to adjust the drop of glycerine to such a size that it will spread just to the edges of the cover-glass and no further. If the slide be perfectly clean, the preparation may then be "ringed" at once with gold-size, and this will usually be sufficient, especially if the ringing be repeated after a day or two. As an additional precaution, the ringing may be done first with melted glycerine-jelly, and later with gold-size or other cement.

Instead of mounting them permanently in glycerine, specimens may be transferred from this to melted glycerine-jelly. This medium, though not giving quite equal transparency, has the advantage of setting solid, so that the preparations are more easily cemented and there is no risk of leakage. Such preparations must, however, when set, be carefully ringed with some kind of cement, gold-size being one of the best.

Lactophenol (Amann).—This reagent has special advantages owing to its property of softening the cuticle and counter-acting shrinkage. The mixture is made up as follows :—

Carbolic acid crystals.	1 part by weight.
Lactic acid	1 part ,, "
Glycerine	2 parts ,, "
Distilled water	1 part ,, "

The use of lactophenol for large or opaque species is not recommended, but it is excellent for the smaller forms. These may be transferred to it direct from either alcohol or formalin, and indeed the writer has found it a very good fixative for living worms of certain kinds, such as *Capillaria* and Trichostrongylids. These should be picked up by one end on a needle or bristle, gently drawn through the lactophenol in order to straighten them, and then left in it.

Violent shrinkage often occurs at first in specimens placed in this reagent, but it will be found that after twelve hours or so they have "plumped out" to their natural proportions. Permanent preparations in lactophenol are rather difficult to cement satisfactorily. Perhaps the best method is to ring them first with glycerine-jelly and afterwards with gold-size. Specimens may also be transferred from lactophenol to pure glycerine or glycerine-jelly. It is, in fact, often useful, when it is desired to bring them into glycerine, to pass them through lactophenol, and so avoid the necessity for the slow process of evaporation described above.

Specimens, especially if too large to be mounted permanently by any of these methods, should not be left too long in lactophenol, as, after its prolonged action on the cuticle, there is a great risk of their bursting when transferred to other fluids.

When it is desired to return lactophenol-cleared specimens to formalin, they may first be simply washed in water. The same procedure may be followed if they are to be brought into alcohol, the strength of the spirit being increased gradually. An alternative method is to wash the specimens directly in acid alcohol (70–80 per cent. alcohol acidulated with hydrochloric acid), before storing them in spirit. This tends to prevent subsequent darkening of the specimens.

Creosote (beechwood).—This is by far the best clearing agent for medium-sized and large species, as it has a relatively high refractive index, and causes little or no shrinkage. Specimens may be transferred to it directly from alcohol of any strength, or even from formalin or water. If a large amount of water is present, it may be necessary to change the creosote once or twice. In clearing alcoholic specimens care must be taken to immerse them completely and at once in the creosote, as otherwise there is a danger of air-spaces being formed and causing opacity. There are several simple ways of preventing this. The specimens may be simply plunged into a dish or watch-glass of creosote, and a cover-glass, or a piece of thicker glass, immediately placed over them; or they may be pushed down with a loose plug of cotton-wool into a tube of creosote. Another method, very useful in some cases, is to pour creosote into a tube, and with a pipette to run a layer of alcohol on to the surface of the creosote. The specimens are then dropped into the alcohol, and will shortly begin to sink into the creosote. As soon as they have done this, as much as possible of the alcohol which has not diffused into the creosote should be removed with the pipette.

Small and medium-sized specimens are cleared very rapidly by creosote, and even large worms will become quite translucent if allowed to soak in it overnight. Should there be any trace of glycerine in the specimens, this must be washed out before attempting to clear them.

It is, unfortunately, impossible to mount preparations permanently in creosote, and specimens left in it too long are very liable to become darkened, especially if transferred afterwards to alcohol. In order to prevent discoloration, they should be transferred from the creosote to acid alcohol. The writer uses 80 per cent. alcohol to which hydrochloric acid has been added in the proportion of about 4 per cent. The specimens are usually left in this overnight, and washed in a fresh supply of the same fluid, and then in plain 80 per cent. alcohol, before being returned to their bottle. It is not advisable to leave them indefinitely in acid alcohol containing any trace of creosote, as this seems to intensify the darkening action.

Portions of specimens cleared in creosote can, if desired, be mounted as permanent preparations in Canada balsam. For this purpose it is probably best to use balsam dissolved in creosote, though xylol-balsam can also be used.

If, for any reason, it is desired to stain specimens in bulk before clearing them, the cuticle should first be punctured in several places with a fine needle, in order to allow the stain to penetrate more readily. The writer has occasionally obtained fairly good results with Mayer's paracarmine, differentiated afterwards in the usual way with acid alcohol. The usefulness of this method is limited, but it sometimes brings out details, more particularly of the genital organs, which are difficult to see in unstained specimens.

(d) *Manipulation.*

It may, in some cases, be necessary to cut off portions of specimens for separate mounting and examination. If, for instance, it is desired to obtain an end-on view of the head of a Nematode, this is usually best accomplished by cutting off the head with a very small knife, or with a ground needle, and rolling it into the desired position under a cover-glass. Small "feet" of plasticine at the corners of the cover-glass are a very useful aid in this process, and are better than the strips of paper, glass and other material often recommended, because their thickness can be reduced to the required degree by slight pressure with a needle.

Much can be accomplished with cleared specimens, without damage to them, by simply rolling them into the desired position under a cover-glass. It may require great perseverance to obtain a ventral view of the coiled tail of a male Nematode in this way, but even this can often be done without amputation. The head usually presents much less difficulty. The worm is laid lengthwise on a slide, and a square cover glass applied so that only a short portion of the worm is covered by one of its edges, while the rest of the body is uncovered, or has a second cover-glass placed over its other end. It is usually best to run in the creosote or other temporary mounting medium with a pipette after the cover-glass has been applied. The slide is then placed under the microscope, and with two fingers of one hand the cover-glass is pushed one way or the other until the worm assumes the required position. It is a good plan to use a large slide, to reduce the risk of the creosote or other fluid overflowing on to the stage of the microscope. If the specimen is very "wiry," and there is difficulty in keeping it in position, the cover-glass may sometimes be held down by means of small lumps of plasticine. The somewhat unpleasant action of creosote on the human skin may be mitigated by

previously rubbing glycerine into the finger-tips. For manipulating specimens in creosote it is advisable to avoid, as far as possible, the use of metal instruments, which will become corroded and may cause some discoloration.

CLASSIFICATION.

The parasitic Nematodes, being for the most part larger, more conspicuous and more easily studied than their free-living relatives, have, on the whole, received a greater amount of attention from systematists. But there is reason for believing that the free-living forms, most of which are of very small size, may be quite as numerous, and though, with a few notable exceptions, they appear to be of little or no economic importance, they have been the subject of a great deal of study during the last century. Unfortunately the systematists who have done most to advance our knowledge of the parasitic forms have usually been unable to devote an equal amount of attention to the free-living forms, and *vice versa*. The result is that there has been a tendency for two quite different systems of classification to develop side by side—one in which the parasitic forms receive full consideration, while the free-living forms are treated as an insignificant appendage; and another, of more recent growth, in which the positions are reversed, and the free-living forms are given a quite disproportionate share of attention. It seems obvious that neither system is likely to stand the test of time, and certainly neither of the view-points which have led to the two systems is calculated to dissipate the fog of obscurity in which the group has been enveloped by the writers of almost all general zoological text-books.

Clearly the ideal to be hoped for is a system in which the group will be shown to be a harmonious whole. The number of genera and species already known is so large that this is by no means an easy task, but, zoologically speaking, the group is in reality so homogeneous that there is no excuse, except that of convenience, for the continuance of the present fashion of keeping it, as it were, in two separate "water-tight compartments." The more this practice is followed the greater is the tendency for each school of workers to adopt methods and even a language of its own. Even now a specialist accustomed to dealing with descriptions of parasitic species may meet with works on free-living forms written in terms which are almost wholly unintelligible to him. To the writer, at least, this state of affairs seems highly unsatisfactory, and it appears desirable that strenuous efforts should be made to prevent the further divergence of the two branches of what is, after all, merely one relatively small department of zoological science.

It is unnecessary to review here the many schemes of classification that have been proposed. Some of these have already been referred to in the foregoing discussion of the morphology of the group. There is still little uniformity in the systems adopted by different authorities, but in a general way it may be said that the basis of most of the recent attempts to classify the Nematodes is the series of "superfamilies" employed by Railliet*. Since Railliet dealt only with the parasitic forms, it has been necessary to extend his system to include the free-living Nematodes. An attempt to do this was made by Baylis and Daubney (1926), and it is this classification which is adopted in the present work. The order (or superfamily) ASCAROIDEA was enlarged to include all the forms having three lips, or obvious modifications of three lips. The superfamily OXYUROIDEA thus disappeared, and accommodation was found for the vast majority of the free-living forms. This certainly makes the ASCAROIDEA a very large order, comprising as it does fourteen families, or nearly as many as are assigned to the rest of the orders together. Objections have been made to the system by various writers †, principally specialists on free-living Nematodes. The modifications suggested, however, usually consist in little more than the raising of some of the free-living families to the rank of orders, and if these orders must be distinguished by such small points as the form of the "amphids" or the ornamentation of the cuticle, it is not clear that they represent any great improvement on the simpler arrangement.

* For a summary of Railliet's system see his paper in *Rec. Méd. vét.* xcii, p. 517 (1916).

† *e. g.* Filipjev, 1934, *Smithsonian Misc. Collections*, lxxxix, no. 6.

SYSTEMATIC ACCOUNT OF INDIAN NEMATODES.**Order ASCAROIDEA Railliet and Henry,
1915.**

Free-living or parasitic forms having normally three lips, of which one is dorsal and two subventral. The lips may be subdivided so as to form a multiple of three, or subsidiary lip-like structures (interlabia) may be developed between them. In some cases the lips may be much reduced or apparently absent, but more or less clear indications of their original presence can generally be traced. Œsophagus of variable form; in some families and genera provided with a posterior bulb. Posterior extremity of male usually conical or tapering, with or without lateral alæ and with a variable number of sessile or pedunculate papillæ, but without a true bursa.

Family ASCARIDÆ Cobbold, 1864.

Relatively large, stout, parasitic forms in which there are three well-defined lips. Musculature of the body of the polymyarian type. The dorsal lip bears on its outer surface a pair of papillæ, frequently with double terminations, while each of the ventro-lateral lips also has, as a rule, two papillæ, of which that towards the ventral side is large and often double, while that of the other side is small and often extremely inconspicuous. There may or may not be, on the inner surface of each lip, a transverse series of minute denticles, known as a dentigerous ridge. Between the bases of the main lips three smaller, conical, subsidiary lips, or interlabia, may be present. There is no chitinoid buccal capsule or pharynx. The œsophagus is usually simple, club-shaped and muscular, but may be connected posteriorly with a small, muscular, spherical bulb, without internal valves, or with a specialized granular structure, possibly glandular in function, termed a ventriculus. In certain forms this ventriculus gives rise to one or more solid appendices of similar histological structure, while there may also be one or more blind anterior prolongations, or cæca, springing from the intestine immediately behind its junction with the œsophagus or ventriculus.

Caudal alæ usually absent or very slightly developed in the male. A large number of caudal papillæ usually present,

of which the majority are preanal. Spicules paired and equal or subequal in length, with or without lateral flanges or alæ. Accessory piece usually absent. Vulva usually somewhat in front of the middle of the body. Vagina and uterus run posteriorly from the vulva, the uterus having, as a rule, two parallel branches (occasionally four or six). Worms oviparous, producing very large numbers of eggs, the contents of which are unsegmented at the time of laying.

Subfamily ASCARINÆ Travassos, 1913.

Œsophagus without well-marked ventriculus, though a small muscular bulb, or a small granular posterior portion, may be present. Accessory piece absent. Life-history typically direct, no intermediate host being necessary.

Key to Genera.

- | | |
|---|----------------------|
| Adults parasitic in mammals | 1. |
| Adults parasitic in reptiles | 3. |
| 1. Cervical alæ absent | ASCARIS, p. 35. |
| Cervical alæ present .. . | 2. |
| 2. Anterior end of body bent ventrally ;
œsophagus with muscular bulb posteriorly .. . | TOXOCARA, p. 58. |
| Anterior end of body bent dorsally ;
œsophagus without bulb | TOXASCARIS, p. 62. |
| 3. Interlabia and interlabial grooves present ;
uterine branches two .. . | OPHIDASCARIS, p. 44. |
| Interlabia and interlabial grooves absent ;
uterine branches four or six | POLYDELPHIS, p. 48. |

1. Genus **ASCARIS** Linnæus, 1758.

Synonyms :—*Stomachida* Pereboom, 1780 ; *Fusaria* Zeder, 1800 ; *Lombricoides* Mérat, 1821 ; *Parascaris* Yorke and Maplestone, 1926 ; *Neoscaris* Travassos, 1927.

Cervical alæ absent. Lips with dentigerous ridges. Interlabia absent or extremely reduced. No interlabial grooves at bases of lips. Male with five or six pairs of postanal papillæ, of which one or more of the anterior pairs have double terminations. Preanal papillæ numerous and irregularly arranged. Spicules non-alate, tubular, relatively short and stout. Vulva near middle of body or anterior to it. Uterine branches two. Adult worms in small intestine of mammals.

Genotype :—*Ascaris lumbricoides* L., 1758.

Key to Species.

- | | |
|---|------------------------------|
| Head not distinctly marked off from neck. | <i>lumbricoides</i> , p. 36. |
| Head wider than neck .. | <i>equorum</i> , p. 39. |
| Head narrower than neck | <i>vitulorum</i> , p. 41. |

1. *Ascaris lumbricoides* Linnæus, 1758. (Figs. 1 & 2).

Synonyms :—[*Lumbricus teres* Tyson, 1683, pre-Linnean]; *Ascaris gigas* Goeze, 1782; *Ascaris suum* Goeze, 1782; *Ascaris suis* Gmelin, 1790; *Fusaria lumbricoides hominum* and *F. l. suis* Zeder, 1800; *Fusaria lumbricoides suum* Rudolphi, 1809; *Lumbricus teres hominis* Rudolphi, 1809; *Ascaris gigas hominis* and *A. g. suis* Rudolphi, 1809; *Ascaris ovis* Rudolphi, 1819; *Ascaris suilla* Dujardin, 1845; *Ascaris bifaria* Baird, 1853.

Hosts:—Man (infestation very common in India)*; pig (*Sus scrofa*); Indian wild boar (*Sus cristatus*) (Baylis and Daubney); large Indian squirrel (*Sciurus indicus*) and Irrawaddy squirrel (*Sciurus pygerythrus*), Zoological Gardens, Calcutta (Baylis and Daubney). The species is of cosmopolitan distribution, and occurs also in the larger apes, occasionally in sheep and cattle, and apparently rarely in the dog. The forms found

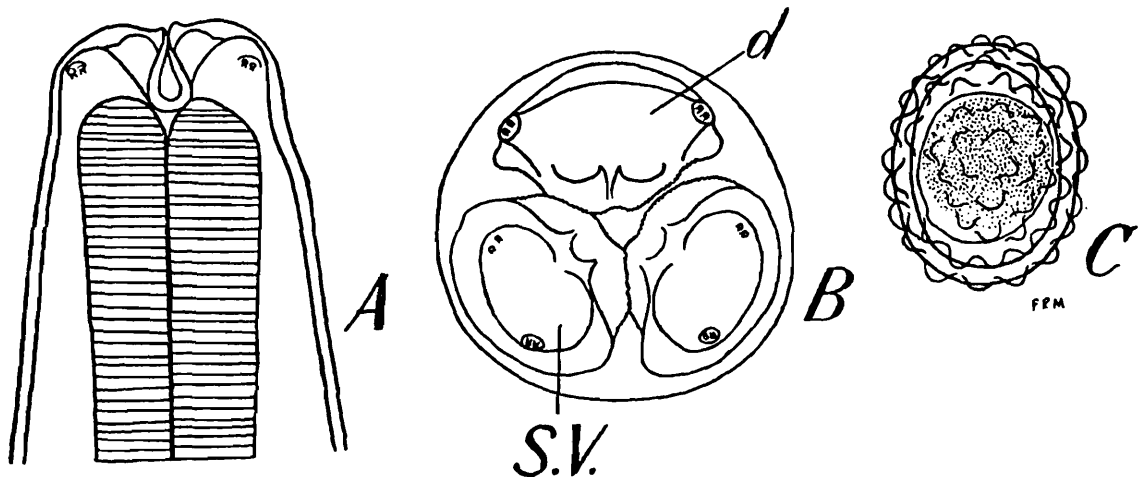

Fig. 1.—*Ascaris lumbricoides*. A, anterior end, ventral view; B, lips, en face; C, egg. d., dorsal lip; s.v., subventral lip. (From Baylis, after Yorke and Maplestone).

in man and the pig, although morphologically indistinguishable, are regarded by some authorities as physiologically distinct varieties or races.

Ascaris lumbricoides, the common "roundworm" of man, is probably the most familiar of all parasitic worms. It has been known from very early times, its large size and extremely common occurrence having naturally caused it to be one of the first species to attract attention. The male attains a length of 150–250 mm. (exceptionally as much as 310 mm.) and the female of 200–400 mm. or even more. The maximum thickness is about 3–5 mm. The lateral fields appear as

* A recent report by Sweet (1929) gives the average incidence among the population of different districts of the State of Mysore as 34.2 per cent., while in certain districts the incidence was as high as 74.4 per cent.

a pair of whitish lines running throughout the length of the worm. The body tapers gradually towards each end. At the anterior end it passes without any sudden change of diameter into the "head," which consists of three lips of semicircular or somewhat quadrangular outline. The dorsal lip bears on its outer surface a pair of large, lozenge-shaped, double papillæ, while each of the ventro-lateral lips carries one double papilla ventrally and two very small, simple papillæ, close together, laterally. The pulp of each lip is produced anteriorly into a pair of blunt lobes, and there is also a rounded median lobe situated towards the inner surface of the lip. The œsophagus varies in length from about 6.5 to 15 mm.

The caudal end of the male is conical and almost invariably curled towards the ventral side. The tail itself is flattened

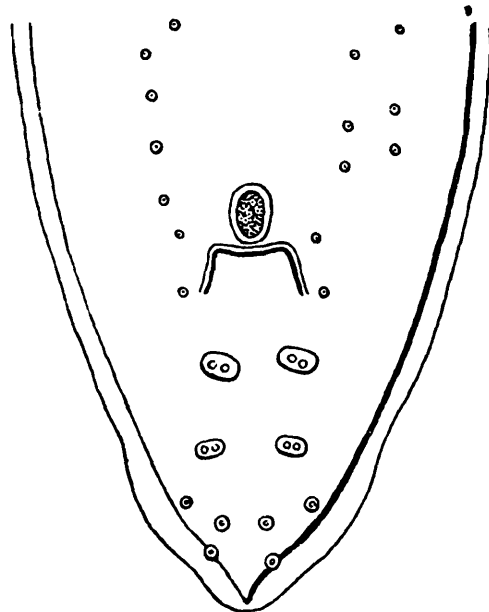

Fig. 2.—*Ascaris lumbricoides*. Posterior end of male ; ventral view.
(After Schneider.)

ventrally. There are about 70 to 75 pairs of caudal papillæ, of which five pairs are postanal. Of these the two anterior pairs are large papillæ with double terminations, while the three posterior papillæ are arranged in a triangle on either side. The preanal papillæ are very irregularly arranged, forming a single longitudinal row on each side for a short distance in front of the cloaca, then several confused rows, and finally, anteriorly, single rows again. At some little distance from the cloaca there is constantly a pair of double papillæ in the series, though these are usually very asymmetrical in position. A large, median, cushion-like papilla is also present just in front of the cloacal aperture. The

spicules are equal in length (about 2 mm.) and are broad, dorso-ventrally flattened, somewhat widened in their distal half and without alæ.

The tail of the female is short, straight and conical. The vulva is situated at about the anterior third of the body, frequently in a shallow annular constriction. The vagina is narrow and about 6 mm. long. It usually runs forward for a short distance from the vulva, then doubles back sharply, close to the ventral body-wall, and passes into the unpaired portion of the uterus, which widens gradually and is about 10 mm. long. This gives off two relatively wide uterine branches which run back, parallel to each other, to within about 20–30 mm. from the posterior end, where they turn forward and pass into the narrower ovarian tubes. These form several antero-posterior loops and are also thrown into innumerable secondary loops in a transverse direction. Their convolutions occupy almost the whole of the body-cavity between the anus and the vulva. The length of the uterine branches, when stretched out, may reach about 200 mm., and that of the ovarian tubes, with their ducts, about 1250 mm.

The eggs are very characteristic. They are oval, and have thick shells which are covered before laying with an irregular coat of a viscid albuminous substance, giving them a coarsely mammillated appearance. This albuminous coat, which is transparent and colourless while the eggs remain in the vagina, becomes stained brown by the bile-pigment in the host's fæces after the eggs are laid. The size of the eggs varies very considerably, measurements given by different authors ranging from 0.045 to 0.0875 mm. in length and from 0.035 to 0.0575 mm. in width. The contents of the eggs are usually unsegmented at the time of laying. Unfertilized eggs, without the albuminous coat, are not infrequently observed. These are generally longer and narrower than the normal eggs.

The life-history of this species, thanks to the researches of Stewart, Ransom, Yoshida and other investigators, is now well known. As it is probably typical of those Ascarids which do not require an intermediate host, a brief summary of it may be given here. The eggs reach the infective stage after lying in the open for some weeks, during which period they are extremely resistant to environmental conditions such as cold and dryness, and to chemical substances. They can remain alive and infective for several years. If ingested by a suitable mammal, they hatch in the small intestine, and the larvæ burrow into the wall of the intestine and penetrate into the small mesenteric veins or lymphatic vessels. Carried by the blood-stream of the portal system, they reach

the liver, and are thence taken to the heart and by way of the pulmonary arteries to the lungs. Here they rupture the capillaries and escape into the alveoli, grow and moult, and finally migrate up the bronchi and trachea. Reaching the mouth, they are swallowed a second time. The fourth and last moult takes place soon after the young worms reach the intestine, where they now rapidly develop to maturity.

2. *Ascaris equorum* Goeze, 1782. (Fig. 3.)

Synonyms:—*Fusaria lumbricoides equorum* Zeder, 1800; *Ascaris gigas equi* Rudolphi, 1809; *Ascaris megalcephala* Cloquet, 1824; *Ascaris lævissima* Baird, 1853; *Parascaris equorum* Yorke and Maplestone, 1926.

Hosts:—This species occurs chiefly in equine animals (horse, donkey, mule and zebra), and is of world-wide distribution. In India it has been recorded from horses by Gaiger and by Baylis and Daubney. According to Gaiger it is very common in the Punjab. *Ascaris equorum* has occasionally been recorded from cattle, though there is possibly some doubt as to the specific determination. Baylis and Daubney (1923, *b*) refer to a single female specimen, possibly of this species, in the collection of the Zoological Survey of India, which was labelled as "from the intestines of cattle." The type-specimen of *Ascaris lævissima* Baird, which is regarded by the present writer as a synonym of *A. equorum*, was of Indian origin, but its host is unknown.

Ascaris equorum is very similar in general appearance to *A. lumbricoides*, and has about the same range of size, though its average size is perhaps slightly larger. The male varies in length from about 150 to 280 mm., the female from 180 to 370 mm. The worm is rather stouter than *A. lumbricoides*, the female attaining a thickness of about 8 mm. An easily recognized difference from other species is to be found in the relative size of the "head." In *A. equorum* the "head" is distinctly wider than the "neck" immediately behind it. The lips are relatively large, and of characteristic shape. Each lip has a well-marked and rather narrow anterior lobe, separated from the very broad basal portion by deep transverse grooves at its sides on the inner surface. The pulp of the lip has paired anterior lobes which are slightly emarginate at their ends. Between the lips there are slight rudiments of interlabia. These structures are absent in *A. lumbricoides* and in *A. vitulorum*, the common Ascarid of cattle.

The tail of the male is flattened ventrally and its cuticle is expanded laterally to form slight alæ. There are, according to Schneider, from 79 to 105 pairs of caudal papillæ. Of these, five pairs are postanal, the two anterior

pairs of postanal papillæ having double terminations. The first four pairs of preanal papillæ form single rows. Anteriorly to these for some distance the papillæ form two or three confused and irregular rows on each side, and still more anteriorly (from about the 40th pair onwards) single rows

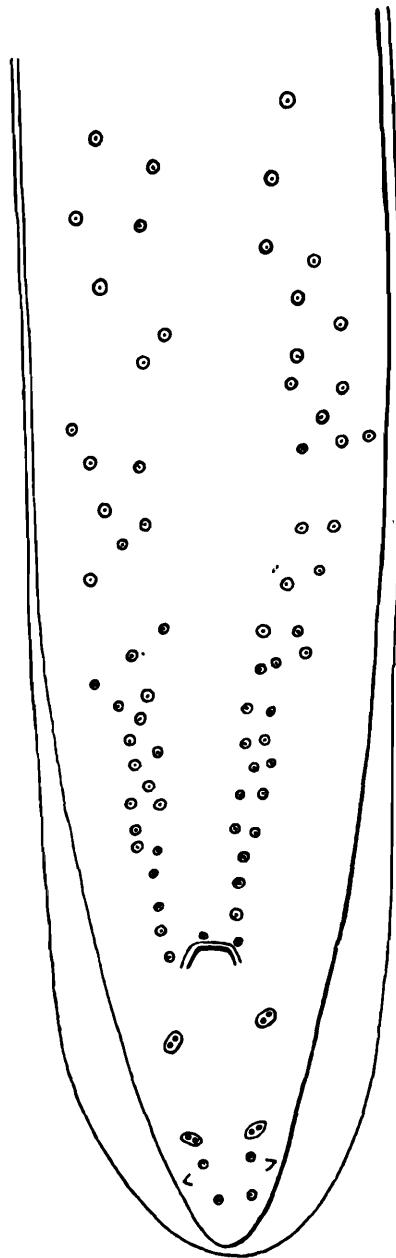

Fig. 3.—*Ascaris equorum*. Posterior end of male; ventral view.
(After Schneider.)

again. There is a small median papilla on the anterior lip of the cloacal aperture.

The vulva of the female is situated at about the anterior quarter of the body. The vagina is relatively short, and the uterus has the same general structure as in *A. lumbricoides*. The eggs are almost spherical, and have finely pitted shells measuring about 0.09–0.1 mm. in diameter.

3. *Ascaris vitulorum* Goeze, 1782. (Figs. 4-6.)

Synonyms :—*Lumbricus teres vituli* Rudolphi, 1809 ; *Ascaris gigas vituli* Rudolphi, 1809 ; *Ascaris vituli* Neumann, 1883, nec Gmelin, 1790 ; *Neoascaris vitulorum* Travassos, 1927.

Hosts :—This species has been recorded from cattle and buffaloes in various parts of Asia, Europe, Africa, the Philippines, West Indies and America. It is usually found in calves. Indian records are : domesticated buffalo (*Bos bubalus*), Punjab (Boulenger) ; zebu (*Bos indicus*), Colombo, Ceylon (v. Linstow) ; “ calf ” (probably *Bos indicus*), Siripur, Bihar (Baylis and Daubney).

On account of the discrepancies between various existing descriptions of this worm, based on material from different parts of the world, it has been suggested that two or more

Fig. 4.

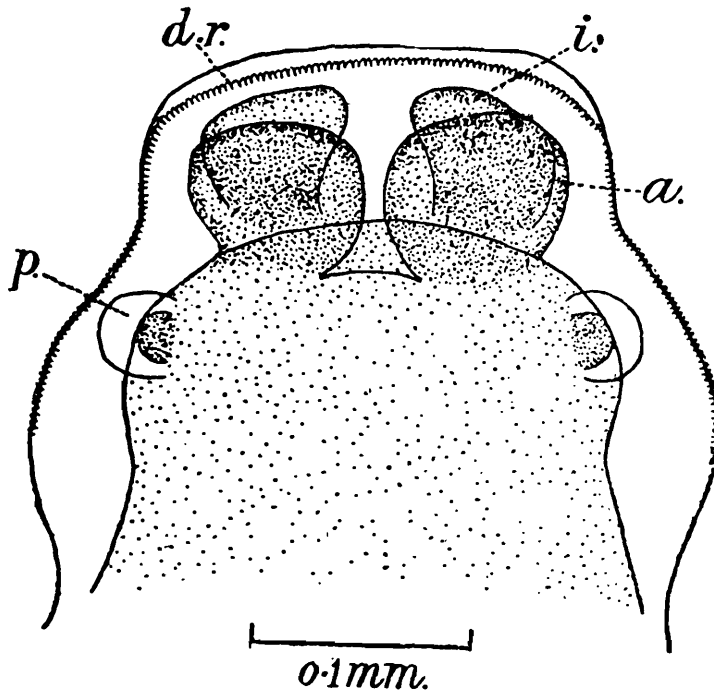

Fig. 4.—*Ascaris vitulorum*. Dorsal lip, viewed from exterior. *a.*, anterior lobe of pulp ; *d.r.*, dentigerous ridge ; *i.*, internal process of anterior lobe ; *p.*, papilla. (After Baylis and Daubney.)

closely related species may have been confused. It appears more probable, however, that *A. vitulorum* is a somewhat variable species. The following description is based on the accounts given by Boulenger, Macfie, and Baylis and Daubney, as well as the summary given by Ransom (1911) of the description by Neumann.

The length of the male varies from 85 to 250 mm., that of the female from 155 to 300 mm. The maximum thickness is 3-5 mm. in the male, 5-6 mm. in the female. The intervals between the cuticular striations appear to be very variable

Fig. 5.

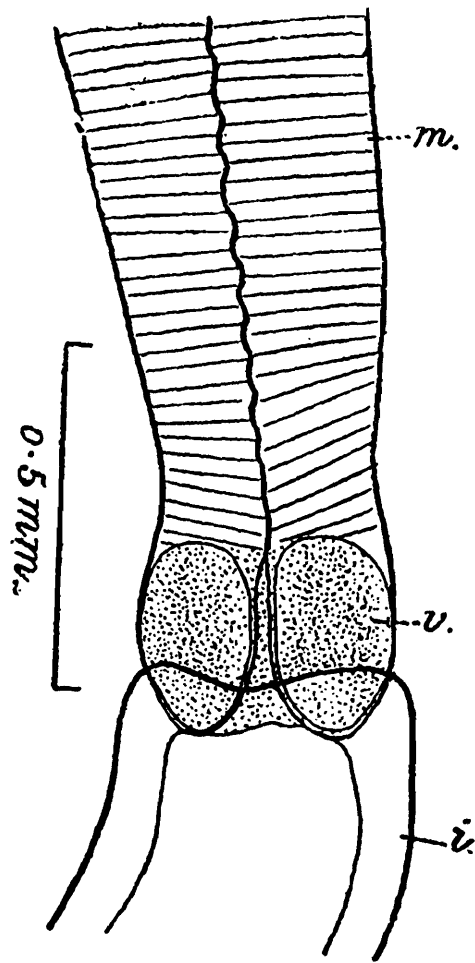

Fig. 6.

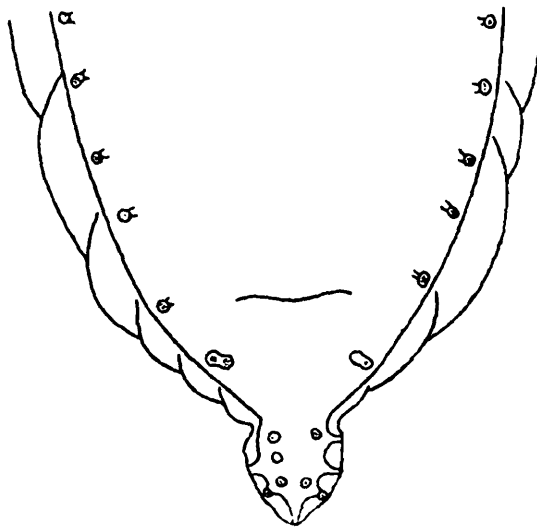

Fig. 5.—*Ascaris vitulorum*. Part of oesophagus and intestine. *i.*, intestine; *m.*, muscular portion of oesophagus; *v.*, ventriculus. (After Baylis and Daubney.)

Fig. 6.—*Ascaris vitulorum*. Posterior end of male; ventral view. (After Boulenger.)

(30–90 μ). The “head” has a diameter of 0.5–0.95 mm., and is distinctly narrower than the “neck,” which forms a kind of “shoulder” behind the lips. These are broad at the base and narrower in front. The dorsal lip bears a pair of large, simple papillæ, each ventro-lateral lip a large, lozenge-shaped papilla towards its ventral margin and a small, round papilla laterally and more anteriorly. The pulp of each lip sends out two rounded lobes anteriorly, and from the inner surface of each lobe a blunt, inwardly-directed process originates. The two processes converge slightly towards the middle line of the lip. There are no interlabia. The œsophagus is about 3–5 mm. long, and has a maximum thickness of 0.8–0.9 mm. It is modified at its posterior end to form a very small “ventriculus,” or granular bulb. This measures 0.35–0.6 mm. in length and 0.45–0.8 mm. in width, and is not distinctly constricted off from the muscular portion of the œsophagus, but is preceded by a slight narrowing of its diameter. The nerve-ring surrounds the œsophagus at about 0.8 mm. from the anterior extremity.

The tail of the male is 0.33–0.45 mm. long. There is a constricted-off terminal appendage, with slight lateral alæ. On this appendage there appear to be usually four pairs of papillæ, two ventral and two dorsal. Between the appendage and the cloaca there is a pair of very large, double papillæ. The preanal papillæ are apparently very variable in number. Baylis and Daubney found about nine pairs, Boulenger 13 pairs and Macfie 30 to 40 pairs. The spicules are equal or subequal and measure about 0.9–1.25 mm. in length. Their maximum thickness anteriorly is 0.04–0.043 mm., and they taper posteriorly to end in blunt points.

The tail of the female is conical and 0.6–1.1 mm. long. The vulva is situated at about one-ninth to one-seventh of the total length from the anterior end. The vagina is 10–11 mm. long, the unpaired portion of the uterus 12–20 mm. The uterine branches are relatively short (about 70 mm.). Boulenger observed swellings at their junction with the oviducts, while in the specimens examined by Macfie these swellings appeared to be absent. The coils of the ovarian tubes return anteriorly as far as the level of the vulva. The eggs are oval and have thick, coarsely granulated shells measuring 0.075–0.095 \times 0.06–0.075 mm. Their contents are unsegmented at the time of laying.

4. *Ascaris* sp.

Baylis and Daubney (1922) have recorded a small, immature female *Ascaris* from the intestine of a wild pig (*Sus cristatus* [*bengalensis*]) near Dinapore, Bihar. It was uncertain whether this was referable to *A. lumbricoides*.

2. Genus **OPHIDASCARIS** Baylis, 1921.

Cervical alæ absent. Lips almost square ; dorsal lip slightly smaller than ventro-lateral lips. Dentigerous ridges present. Interlabia usually well developed. Deep transverse interlabial grooves run from the interlabia partially round the bases of the lips. Œsophagus without bulb or ventriculus. Male typically with six pairs of postanal papillæ, the most anterior pair frequently having double terminations. Preanal papillæ numerous. Spicules subequal, alate. Vulva usually in posterior half of body. Genital organs in both sexes usually confined to posterior region of body, which often shows a fusiform thickening. Uterine branches two. Adult worms in alimentary canal of reptiles.

Genotype :—*Ophidascaris filaria* (Dujardin, 1845).

Key to Species.

Parasite of pythons	<i>filaria</i> , p. 44.
Parasite of <i>Tropidonotus</i>	<i>gestri</i> , p. 46.
Parasite of cobra and krait.	<i>naixæ</i> , p. 46.

1. **Ophidascaris filaria** (Duj., 1845) Baylis, 1921. (Fig. 7.)

Synonyms :—*Ascaris filaria* Dujardin, 1845 ; *Ascaris rubicunda*, ♂, Schneider, 1866 ; ? *Ascaris infundibulicola* v. Linstow, 1903.

Hosts :—A “ large serpent,” probably python, Pondicherry (Dujardin) ; *Python molurus*, Bengal (Schneider) ; *Python molurus*, *P. reticulatus*, *Python* sp., Zoological Gardens, Calcutta (Baylis and Daubney).

This species is extremely common in pythons and has a wide geographical distribution, occurring not only in the Asiatic forms, but also in *Python sebæ* in Africa and in *P. spilotes* in Australia. It has also been recorded from a monitor (*Varanus* sp.) in Zanzibar (Baylis, 1921). The adult worms are found in the intestine. Immature forms have been found on several occasions in the lungs of *Python molurus* and *P. reticulatus*. From this it may be inferred that the larvæ go through a course of migration within the body of the host before settling permanently in the intestine. Their sojourn in the lung appears to be of considerable duration, as they may grow to a length of some 60 mm. in this situation. They do not, however, appear to acquire the definitive structure of the lips before leaving the lung.

The adult worms attain a length of about 110 mm. in the male and 170 mm. in the female. The maximum thickness is about 1 mm. in the male and 1.5 mm. in the female. The cuticular striations are about 3 μ apart. The body is greatly elongate and a little more tapering in front than behind. Each

lip bears two papillæ. Those of the dorsal lip have double terminations, while each ventro-lateral lip has a large papilla towards the ventral and a smaller papilla towards the lateral margin. The dorsal lip has a slightly emarginate anterior border and rounded free angles. The free end of each lobe of the pulp is multiradiate, with an antler-like lobule directed laterally and posteriorly. The interlabia are short and bluntly conical. There are well-developed grooves at the bases of the lips. The œsophagus is 5–7 mm. long and is somewhat swollen posteriorly. The excretory pore is at about 1.4 mm. from the anterior end.

The tail of the male is bluntly conical. There are six pairs of postanal papillæ, of which the most anterior pair are

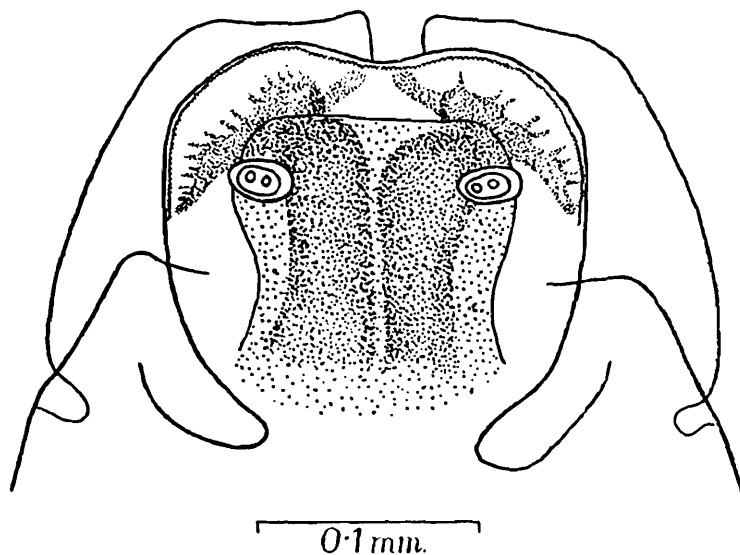

Fig. 7.—*Ophidascaris filaria*. Head; dorsal view.
(After Baylis, in 'Parasitology.')

situated a little behind the cloaca and have double terminations. The other five pairs form an almost circular group on either side near the tip of the tail. The spicules are slightly unequal and measure about 4–4.8 mm. in length. Their tips are rounded. The width of the spicules, including the shaft and alæ, is 0.06–0.07 mm.

The tail of the female is bluntly conical and about 0.3 mm. long. The vulva is situated considerably behind the middle of the body, dividing the total length in the proportion of about 7 : 4. The vagina is simple and muscular, 0.15 mm. in diameter. It sometimes runs forward at first from the vulva, then doubles back with a sinuous course and passes, a little behind the level of the vulva, into an oval swelling measuring about 0.4 × 0.27 mm. This is followed by a straight, unpaired portion of the uterus, about 4 mm. long and having a maximum width of 0.4 mm. The uterus divides

into two wide branches which run posteriorly, parallel to each other, and pass suddenly into two short, narrow, muscular ducts which, after a course of about 0·7 mm., expand into fusiform swellings and then join the oviducts. The ovaries turn forward soon after their origin, the anterior limit of their coils being at about the level of the bifurcation of the uterus, from which point they return to the posterior end, terminating at about 1·5 mm. in front of the anus. The eggs are nearly spherical and measure 0·065–0·073 mm. in diameter.

2. *Ophidascaris gestri* (Parona, 1889) Baylis, 1921.

Synonym :—*Ascaris gestri* Parona, 1889.

Host :—*Tropidonotus piscator* [*T. quincunciatus*], Northern Tenasserim (Parona); Botanical Gardens, Calcutta, and Dibrugarh, Assam (Baylis and Daubney).

In this species, according to Parona's description, the length of the male is 55–67 mm., that of the female 55–78 mm. The maximum thickness is 1 mm., and the cuticular striations are fine. The body is elongate and slender, not tapering much at the extremities. The dorsal lip bears two small, rounded, marginal papillæ. The ventro-lateral lips have two [? two each] small papillæ on their margins anteriorly, and have an indentation on each side at their bases.

The tail of the male has a terminal spike. The caudal papillæ are small and sessile, and consist of two pairs of postanal and ten pairs of preanal papillæ. The spicules are long and equal, with rounded tips.

The tail of the female is very short and has a terminal spike. The vulva is in the anterior third of the body.

The specimens recorded by Baylis and Daubney (1923) were in poor condition, and their determination is somewhat doubtful.

3. *Ophidascaris naiæ* (Gedoelst, 1916) Baylis, 1921. (Figs. 8 & 9.)

Synonym :—*Ascaris naiæ* Gedoelst, 1916.

Hosts :—Cobra (*Naja tripudians*), Sura Ghat; kraits (*Bungarus fasciatus*, *B. bungaroides*), Zoological Gardens, Calcutta (Baylis and Daubney). Originally recorded from *Naja nigricollis*, Belgian Congo.

The length of this species, according to Gedoelst, is 62 mm. in the male and 56·7 mm. in the female, and the maximum thickness is 1–1·07 mm. The cuticular striations are 2·5–3 μ apart. The body is more tapering in front than behind. The dorsal lip, in material from *Naja tripudians*, bears two double papillæ. The pulp sends out two lobes, each of which is

prolonged in opposite directions into two points, one running forward and towards the middle line of the lip, the other backward and towards the margin. The interlabia are small and narrow, with rounded extremities, and about one-third the length of the lips. The œsophagus may attain a length of 3.25 mm. or more in the female (Gedoelst gives 2.9 mm.). The nerve-ring is situated within its anterior fifth.

Fig. 8.

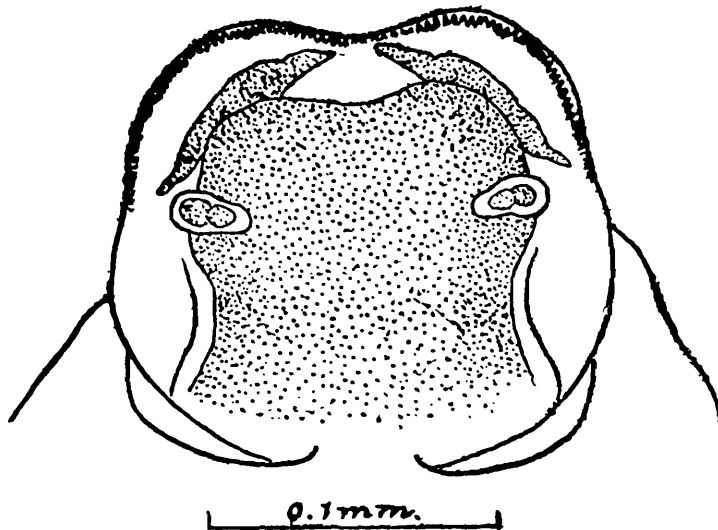

Fig. 9.



Fig. 8.—*Ophidascaris naiæ*. Dorsal lip of female, viewed from exterior. (After Baylis and Daubney.)

Fig. 9.—*Ophidascaris naiæ*. Posterior end of male; ventral view. (After Baylis and Daubney.)

The tail of the male is about 0.2 mm. long. There are six pairs of postanal papillæ. The three nearest to the tip of the tail on either side form a triangle, two being lateral or subdorsal, the third smaller and subventral. A little more

anteriorly there are two ventral pairs, and at the sides of the cloacal aperture, somewhat widely separated from the rest, a pair of very large papillæ apparently having double terminations. There are about 35 pairs of preanal papillæ. The spicules have blunt tips and are slightly unequal in length. Gedoelst gives their lengths as 5.04 and 4.64 mm. In a male from *Naja tripudians* they measured 4.3 and 3.25 mm. respectively, the longer being the left spicule.

In the female the tail is 0.24 mm. long and has a conical tip. The vulva, according to Gedoelst, is in the middle of the body. In Indian material it was found to be considerably behind the middle (at 21.7 mm. from the posterior end in a specimen just under 51 mm. long.). The vagina is long, narrow and sinuous, and passes gradually into the unpaired portion of the uterus. This and the two uterine branches are very short. The branches, after a sinuous course occupying about 10 mm. in the 51 mm. specimen, pass suddenly into short, narrow, muscular canals, and these again into the wider oviducts. The coils of the ovarian tubes extend backward to about 4 mm. from the posterior end and forward to the level of the vulva. The eggs are elliptical and have thick, finely punctate shells measuring 0.08×0.072 mm.

3. Genus **POLYDELPHIS** Dujardin, 1845.

Synonym :—*Hexametra* Travassos, 1920.

Cervical alæ absent. Lips oblong or more or less hexagonal, frequently longer than broad and usually broader at the base than at the free edge. Dorsal lip usually smaller than the ventro-lateral lips. Pulp of ventro-lateral lips asymmetrical. Interlabia and interlabial grooves absent. Œsophagus without bulb or ventriculus. A rudimentary intestinal cæcum occasionally present. Spicules subequal, alate. Caudal papillæ of male typically as in *Ophidascaris*. Vulva usually in anterior region of body, rarely behind the middle. Uterine branches four or six. Adult worms in alimentary canal of reptiles.

Genotype :—*Polydelphis anoura* Dujardin, 1845.

Key to Species.

- | | |
|---|---------------------------|
| Parasites of pythons. Uterine branches | |
| four | 1. |
| Parasites of other reptiles | 2. |
| 1. Length up to 116 mm. (♂), 144 mm. (♀). | |
| Postanal papillæ of ♂ 6 pairs. Spicules | |
| 10.5 mm. Vulva at about anterior third. | <i>anoura</i> , p. 49. |
| Length up to 190 mm. (♂), 258 mm. (♀). | |
| Postanal papillæ of ♂ 5 pairs. Spicules | |
| 7-9 mm. Vulva at about anterior fifth. | <i>attenuata</i> , p. 51. |

- Length 58 mm. (♂), 63 mm. (♀). Postanal papillæ of ♂ 2 (?) pairs. Spicules 5.4 mm. Vulva at anterior third
- | | |
|---|--------------------------------|
| | <i>oculata</i> , p. 52. |
| 2. Uterine branches six | 3. |
| Uterine branches four. Parasite of Colubrine snakes (<i>Tropidonotus</i>) | <i>brachycheilos</i> , p. 52. |
| 3. Parasite of snakes (<i>Tropidonotus</i> , <i>Bungarus</i>). | <i>sewelli</i> , p. 54. |
| Parasite of lizards (<i>Calotes</i>) | <i>rotundicaudata</i> , p. 56. |

1. *Polydelphis anoura* Duj., 1845. (Figs. 10 & 11.)

Synonyms:—*Ascaris (Polydelphis) anoura* Dujardin, 1845; *Ascaris anoura* Creplin, 1848; *Ascaris attenuata* of Stossich, 1896 (part); *Ascaris attenuata*, ♂, of v. Linstow, 1899; *Ascaris pythonis* "Retzius, 1830" of Railliet and Henry, 1910 (part); *Ascaris (Polydelphis) pythonis* " (Retzius, 1830) " of Gedoelst, 1916.

Host:—*Python molurus*. This species is common not only in the Indian python, but also in the African species, *Python sebae*. It is said also to occur in a variety of other African and even American snakes, but the determination of the parasite must, in some cases, be regarded with suspicion. Indian localities for its occurrence in *P. molurus* include Nepal Terai and Kichha, Naini-Tal district (Baylis and Daubney, 1923).

The male attains a length of 116 mm., the female of 144 mm. The maximum thickness is about 2.1–2.8 mm. The cuticular striations are 4–10 μ apart. The body is tapering in front and stout posteriorly. The lateral fields are wide and more transparent than the rest of the cuticle. The lips are small, rather longer than broad, and somewhat emarginate in front. The dorsal lip has two large, double papillæ, the ventrolateral lips each a large double papilla towards the ventral side. The pulp of each lip sends out two inwardly and forwardly directed processes with flattened and expanded terminations. The expanded portion has somewhat the outline of a human foot. The œsophagus is about 10 mm. long.

The tail of the male is blunt, with a small terminal spike, and measures about 0.35 mm. in length. There are six pairs of postanal papillæ, of which the three most posterior form a triangle on either side near the tip of the tail. The most anterior pair consists of large, double papillæ situated near the corners of the cloacal aperture. In addition to the two sublateral rows of 25 or more preanal papillæ, there is a median double papilla in front of the cloaca. The spicules are equal, 10.5 mm. long and conically pointed.

The vulva is at a little less than one-third of the total length from the anterior end. The vagina passes gradually into the unpaired portion of the uterus, which has a fusiform swelling at about its middle. The combined length of this

portion and the vagina is about 30 mm. There are four relatively very short uterine branches. These originate in an oval egg-reservoir, and run straight back to end suddenly in narrow muscular canals about 3 mm. long. The latter are separated from the oviducts by globular or fusiform

Fig. 10.

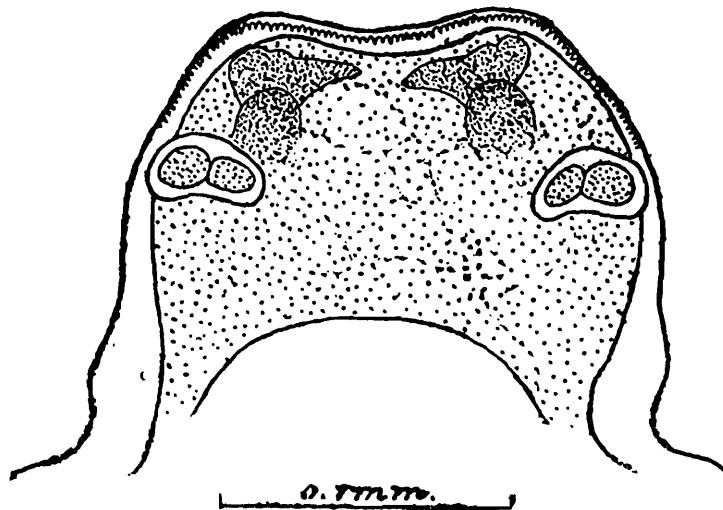

Fig. 11.

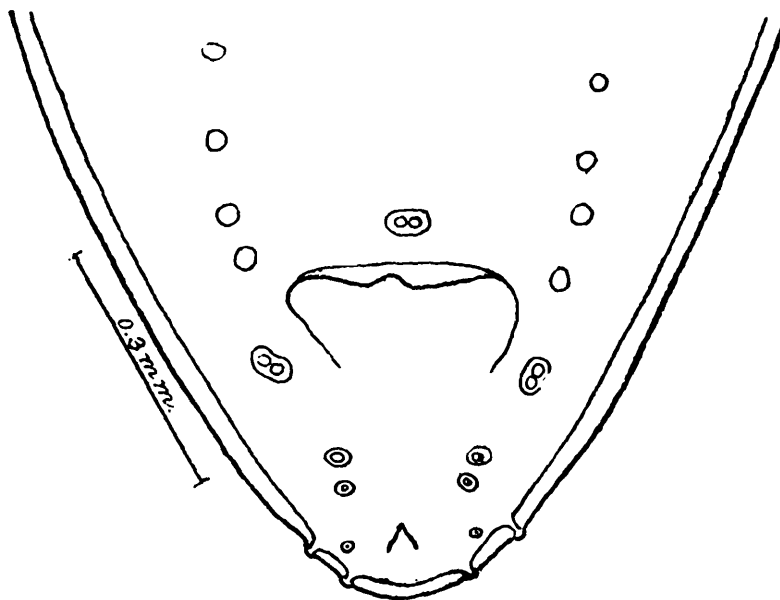

Fig. 10.—*Polydelphis anoura*. Dorsal lip of male, viewed from exterior.
(After Baylis and Daubney.)

Fig. 11.—*Polydelphis anoura*. Posterior end of male; ventral view.
(After Baylis and Daubney.)

swellings. The four genital tubes bend forward soon after the termination of the uterine branches, the ovaries occupying the greater part of the posterior region of the body between the vulva and the anus. The eggs are nearly spherical and measure 0.066–0.072 mm. in diameter.

2. *Polydelphis attenuata* (Molin, 1858) Gedoelst, 1916.
(Fig. 12.)

Synonyms:—*Ascaris attenuata* Molin, 1858; *Ascaris rubicunda*, ♀, Schneider, 1866; *Ascaris pythonis* "Retzius, 1830" of Railliet and Henry, 1910 (part); *Ascaris (Polydelphis) attenuata* Gedoelst, 1916.

Hosts:—*Python molurus*, *P. reticulatus*. Mainly recorded from pythons in various zoological collections in Europe. Stossich has recorded the species from *Python* sp. at Madras, and v. Linstow from *Python molurus* in India. It appears to occur in *P. reticulatus* in the Malay region, and has been recorded from *Python sebæ* and other snakes in Africa.

This species is very similar to the preceding, but attains a considerably greater length. The male may measure up to 190 mm., the female up to 258 mm. The maximum thickness is about 2 mm. in the male and 3 mm. in the female. The cuticular striations are about $3\ \mu$ apart. The lips are relatively small and oblong, somewhat longer than broad,

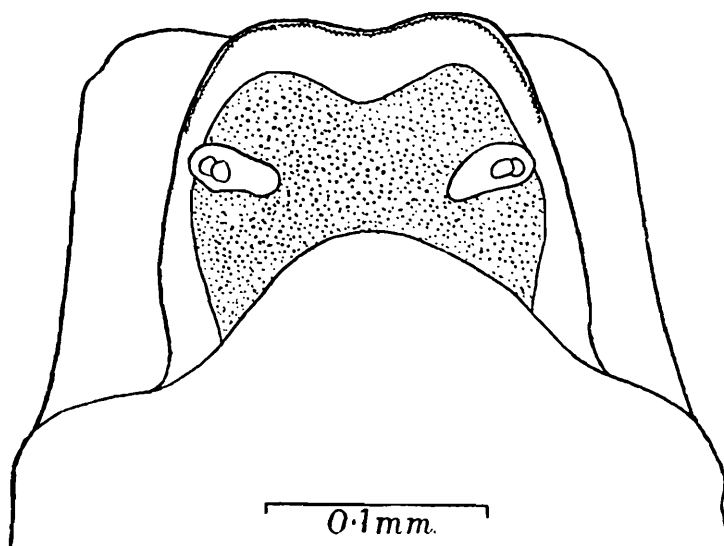

Fig. 12.—*Polydelphis attenuata*. Head; dorsal view.
(After Baylis, in 'Parasitology.')

with slightly emarginate anterior border and rounded angles. The œsophagus is relatively long, occupying one-eleventh to one-ninth of the total length of the body. The nerve-ring is situated at about its anterior eleventh, and the excretory pore a little behind this level.

The tail of the male is conical. There are five pairs of postanal papillæ (two subventral, three lateral) and some 36 pairs of preanal papillæ. The spicules are equal, measuring 7–9 mm., and have blunt tips.

The tail of the female is very blunt, but has a small terminal spike. There is a pair of caudal papillæ at 0.175 mm. from the extremity. The vulva is situated at about the anterior fifth of the body. The vagina widens gradually into the

undivided portion of the uterus. This runs back to a point about 35 mm. from the anterior end of the body, where it gives off four wide branches. These run back and narrow suddenly behind into short muscular canals, about 1.5 mm. long, separated by small swellings from the oviducts. The coils of the ovarian tubes extend back nearly to the posterior end of the body, and then run forward to a point about 5 mm. behind the vulva. The eggs are roundish-oval and measure 0.075–0.09 × 0.065–0.07 mm.

3. *Polydelphis oculata* (v. Linstow, 1899) Railliet and Henry, 1910.

Synonyms:—*Ascaris oculata* v. Linstow, 1899; *Ascaris (Polydelphis) oculata* Railliet and Henry, 1910.

Hosts:—Recorded from *Python reticulatus* (Berlin Museum) by v. Linstow, and from the African python (*P. sebæ*) by Railliet and Henry. Baylis and Daubney (1922) refer to two female specimens from a python (? *P. molurus* or *P. reticulatus*) from Assam, which possibly belonged to this species.

The status of this species appears somewhat doubtful. As has been pointed out by Baylis and Daubney (1923, *b*), v. Linstow's figure of the dorsal lip of *Ascaris oculata* shows a close resemblance to the lip of *P. anoura*. Apart from its smaller measurements, it seems possible that this form may be identical with *P. anoura*. The following description is taken from v. Linstow's account, supplemented by that of Railliet and Henry.

Length, male, 58 mm.; female, 63 mm. Thickness, male, 2 mm.; female, 2.41 mm. Body tapering in anterior third, stout and cylindrical posteriorly. Lips nearly square, with free angles rounded. Dorsal lip slightly broader than long (0.18 × 0.14 mm.). Cephalic papillæ very large. Each lobe of pulp of lip gives off an inward projection. Œsophagus 6 mm. long. Tail of male 1/265 of total length, with a small terminal digitiform appendage. Two pairs of postanal and six pairs of preanal papillæ present. Spicules 5.4 mm. long. Tail of female 1/53 of total length, blunt. Vulva at anterior third of body. Vagina at first simple, slender, sinuous, with a fusiform swelling near its origin, and giving off, at 11 mm. from its origin, four wide branches 20 mm. long, which run backwards. Ova 0.06–0.067 × 0.055–0.06 mm. Larvæ on hatching measure 0.4–0.425 mm. in length.

4. *Polydelphis brachycheilos* (v. Linstow, 1906). (Figs. 13 & 14.)

Synonym:—*Ascaris brachycheilos* v. Linstow, 1906.

Host:—*Tropidonotus piscator* [*T. asperrimus*] (intestine); Colombo, Ceylon.

This species was very briefly and somewhat inaccurately described by v. Linstow. Through the kindness of the Director of the Colombo Museum the writer has been able to re-examine the type-specimens. These consist of two males (one of which lacks the anterior end) and one female.

The male measures 55 mm. in length and about 0.9 mm. in maximum thickness, the female 104 mm. and about 1.5 mm. respectively. The diameter of the head is 0.24 mm. in the

Fig. 13.

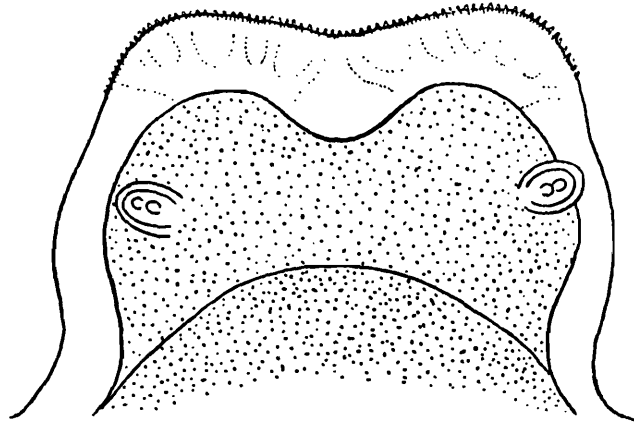

Fig. 14.

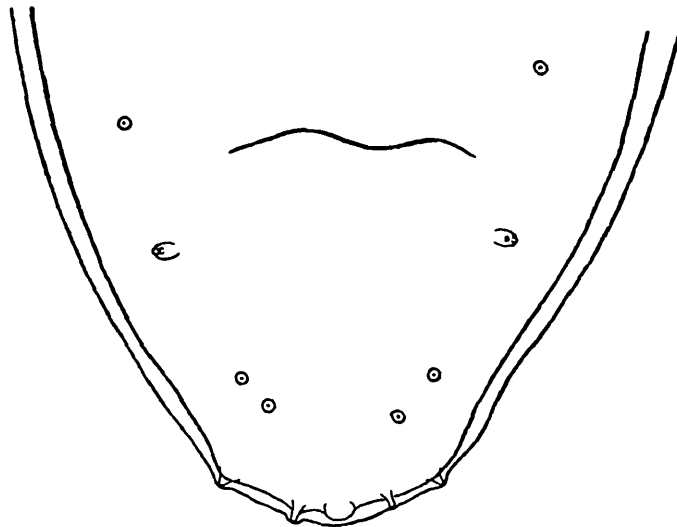

Fig. 13.—*Polydelphis brachycheilos*. Dorsal lip of female, viewed from exterior. (Original.)

Fig. 14.—*Polydelphis brachycheilos*. Posterior end of male; ventral view. (Original.)

male, 0.42 mm. in the female. The lips are somewhat emarginate in front. The "small conical interlabia" mentioned and figured by v. Linstow appear to have been entirely imaginary. No such structures have been detected by the writer. The dorsal lip is 0.17 mm. wide in the male, 0.26 mm. in the female. A prominent marginal dentigerous ridge is present anteriorly. The main pulp-mass of the lip is deeply indented in front, and antler-like branching pulp-processes, very similar to those of *P. sewelli* and other species, appear

to be present, though in the material available they are not very well defined. The cuticular striations on the body, if present, are extremely fine. The œsophagus measures 3·5 mm. in length in the male, 5 mm. in the female. No intestinal cæcum was seen.

The tail of the male is blunt and rounded, but bears a small terminal spike. Excluding the spike, the tail measures 0·21–0·23 mm. in length. The spike itself measures 0·03 mm. v. Linstow mentions only two pairs of postanal and three pairs of preanal papillæ. The writer finds that there are five pairs of postanal papillæ (fig. 14). The most anterior papilla on each side is double, and lies some distance behind the cloacal aperture. Behind the middle of the tail there are two pairs of small subventral papillæ, and at the extremity of the blunt portion two pairs, one of which is subdorsal. The preanal papillæ, of which there appear to be at least 39 pairs, are small and arranged in a fairly regular series on each side. Both spicules appear to be incomplete in one specimen. In the other the right spicule is apparently complete and measures about 1·25 mm. in length. The spicules are provided with alæ.

The tail of the female measures (without the terminal spike, which has been broken off) about 0·4 mm. in length, and is extremely blunt and rounded. The vulva is situated behind the middle of the body, at about 49 mm. from the posterior end, and not, as stated by v. Linstow, near the end of the anterior third. The vagina turns forward at first for a short distance from the vulva, then doubles back and passes into a short uterine trunk. This widens rather suddenly into an oval egg-chamber measuring about 1·2 mm. in length and 0·7 mm. in width, which gives off posteriorly four uterine branches. These run almost straight backwards for a distance of only about 15 mm. before passing into the ovarian tubes. The coils of the latter extend posteriorly only to within about 20 mm. of the hinder end, and anteriorly to a point about 2 mm. in front of the vulva. The eggs are subglobular and have a maximum diameter of about 0·08–0·09 mm. According to v. Linstow, their shells are "closely beset with small granules."

5. ***Polydelphis sewelli*** Baylis and Daubney, 1922. (Figs. 15 & 16.)

Hosts :—Originally recorded from the Montpellier snake (*Cœlopeltis monspessulana*) from Palestine (Baylis and Daubney, 1922); subsequently from *Tropidonotus stolatus*, Lakhimpore, Assam; *T. piscator*, Dibrugarh, Assam; and (probably) *Bungarus fasciatus*, Dibrugarh (Baylis and Daubney, 1923).

The worms are relatively slender and of almost uniform thickness throughout. The male measures about 66 mm. in length and 1.2 mm. in thickness, the female 73 mm. and 1.4 mm. respectively. The cuticular striations are exceedingly fine. The diameter of the head is 0.3–0.34 mm. The lips are somewhat hexagonal in outline and slightly broader than long. Their anterior and lateral borders are somewhat emarginate. The pulp of the dorsal lip has two well-developed antler-like anterior lobes, each having two main divisions. The dorsal lip carries two simple lateral papillæ, each ventro-lateral lip one large ventral and one very small lateral papilla. The œsophagus is somewhat enlarged posteriorly and measures about 5 mm. in length. There is, at least in some individuals, an intestinal cæcum, which may reach a length of about 0.6 mm. or may be quite rudimentary and not more than 0.125 mm. long. A pair of very small cervical papillæ is

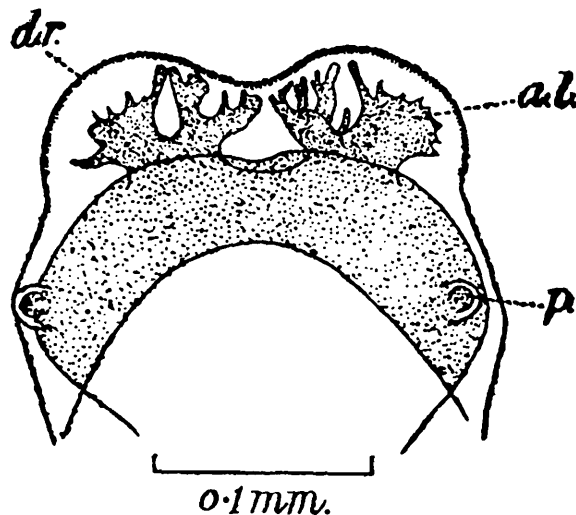

Fig. 15.—*Polydelphis sewelli*. Dorsal lip of female, viewed from exterior. *a.l.*, anterior lobe of pulp; *d.r.*, dentigerous ridge; *p.*, papilla. (After Baylis and Daubney.)

present at about 1.4 mm. from the anterior end. The nerve-ring is situated at 0.7–0.85 mm. from the same point.

The tail, in both sexes, is very short and rounded, and terminates in a small spike about 0.05 mm. long. The tail of the male is 0.25 mm. in length. There are six pairs of postanal papillæ. The most posterior papilla on each side is relatively large and dorsally placed; the second is very small and lateral; the third, fourth and fifth form a triangle, two being ventral and one more lateral; the sixth is a large, double papilla near the cloaca and separated by a considerable space from the rest. The preanal papillæ are arranged in a single fairly regular and close series of about 43 on either side. There is also one papilla, more laterally situated, at about the same level as the fourth of the series, on each

side. The spicules are short, subequal and broadly alate. The right spicule measures 1.35 mm., the left 1.4 mm., and the dorso-ventral diameter of each is about 0.06 mm.

In the female the tail is 0.3 mm. long. The vulva is situated at about 34 mm. from the posterior end, dividing the body in the proportion of about 19:17. The vagina is narrow, muscular and irregularly coiled, and leads into

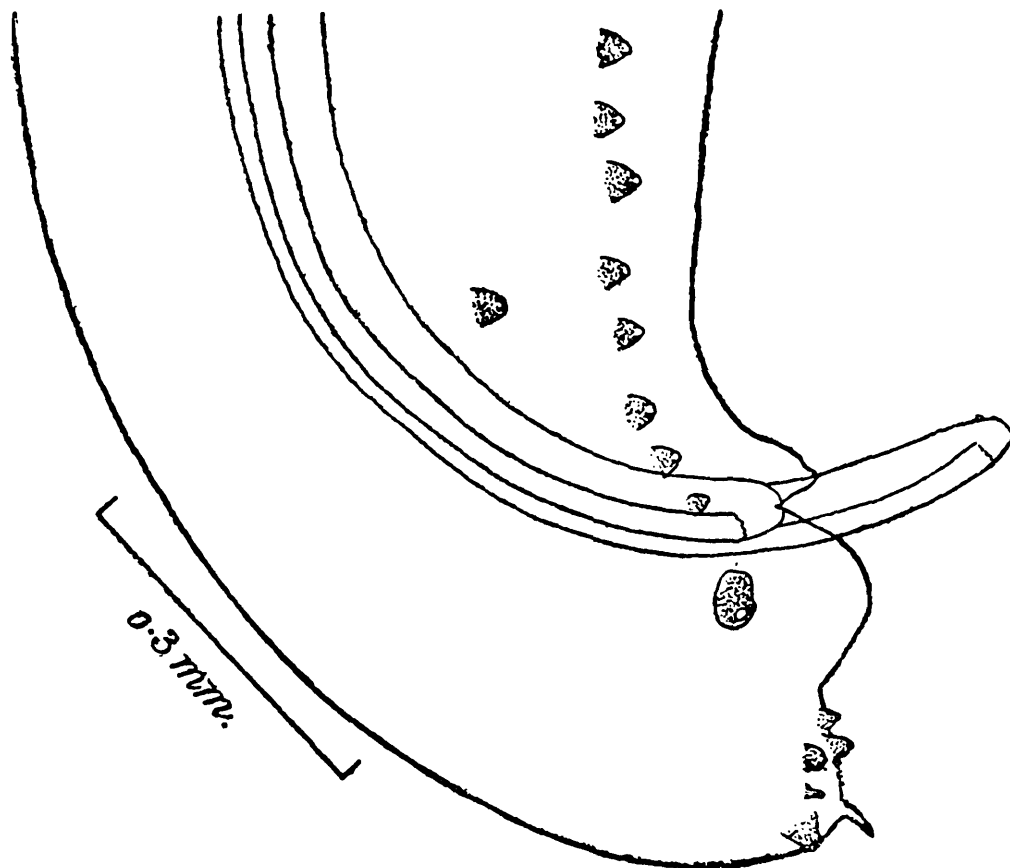

Fig. 16.—*Polydelphis sewelli*. Posterior end of male; lateral view. (After Baylis and Daubney.)

a uterine chamber about 1.6 mm. long, which gives off posteriorly six parallel uterine branches. These run back to a point about 15 mm. from the posterior end, where they pass into the ovarian tubes. The coils of the latter extend back to 10 mm. from the posterior end, and then run forward to the level of the vulva. The eggs are roundish-oval or nearly spherical, and have thick, finely-granulated shells measuring 0.09–0.1 × 0.075–0.087 mm.

6. *Polydelphis rotundicaudata* (v. Linstow, 1904). (Fig. 17.)

Synonym:—*Ascaris rotundicaudata* v. Linstow, 1904.

Host:—*Calotes calotes* [*C. ophiomachus*] (stomach and intestine); Colombo, Ceylon.

Through the kindness of the Director of the Colombo Museum the writer has been able to examine the type-specimens of this species. These include one male and several females. The species proves to belong to the genus *Polydelphis*, and is very closely related to *P. sewelli*, from which it differs only in very slight characters. It seems, in fact, possible that the two forms may be identical, but the material at present available does not enable this question to be definitely decided.

The male measures about 45 mm. in length and nearly 1 mm. in maximum thickness, the females up to 73 mm. and about 1.2 mm. respectively. The diameter of the head is about 0.25–0.34 mm. The dorsal lip is more rectangular

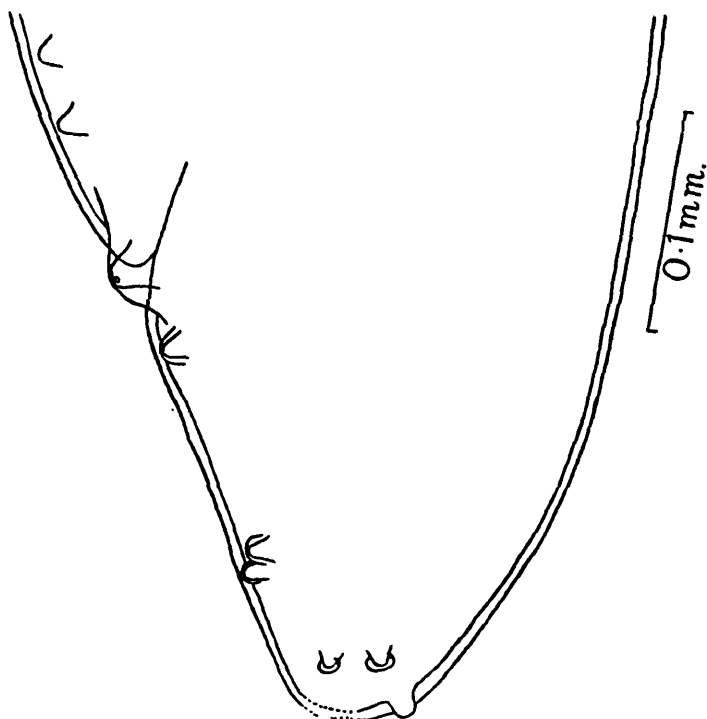

Fig. 17.—*Polydelphis rotundicaudata*. Posterior end of male; lateral view. (Original.)

than in *P. sewelli*, but appears to have very similar branching pulp-processes anteriorly. The œsophagus is much shorter than in *P. sewelli*, measuring only 2.8 mm. in the male and about 3.5 mm. in the largest female. No definite intestinal cæcum was observed. The nerve-ring is situated at about 0.7 mm. from the anterior end in the female.

The tail of the male is about 0.24 mm. long. Its tip, however, has been damaged and the terminal spike (if originally present) has been broken off. There are six pairs of postanal papillæ, arranged as shown in fig. 17, the most posterior pair being subdorsal. There is one pair of rather large adanal papillæ, with double terminations, and about 40 pairs of

preanal papillæ, arranged in fairly regular single series. (According to v. Linstow, there are 31 pairs of preanal and four of postanal papillæ). The spicules measure about 1.27 mm. in length (not 8.8 mm., as stated by v. Linstow), and are provided with broad alæ. Their dorso-ventral width is about 0.08 mm.

The tail of the female is bluntly rounded and measures about 0.36–0.45 mm. in length, including a minute terminal spike about 0.02 mm. long. The vulva, in a 73 mm. specimen, is situated at about 34 mm. from the anterior end, and is thus considerably in front of the middle of the body. The vagina is short, narrow and rather convoluted. At a distance of a little more than 2 mm. behind the vulva the uterus divides into six branches, which run straight back for a distance of about 20–25 mm. and then pass into the narrower oviducts. The eggs are roundish-oval or subglobular, and have a greatest diameter of about 0.08–0.09 mm.

7 *Polydelphis* sp.

Baylis and Daubney (1922) recorded two female specimens, one in very poor condition, taken on separate occasions from examples of the common chamæleon of India (*Chamæleon zeylanicus* [*C. calcaratus*]). They belonged to the section of the genus in which there are six uterine branches, but it was impossible to determine whether, or not, they were identical with *Polydelphis hexametra* (Gedoelst, 1916), a species recorded from *Chamæleon dilepis* in the Belgian Congo.

8. *Polydelphis* sp.

Baylis and Daubney (1923, *b*) also recorded two male specimens of an undetermined species of this genus from the stomach of *Lachesis (Trimeresurus) gramineus*.

4. Genus **TOXOCARA** Stiles, 1905.

Synonym :—*Belascaris* Leiper, 1907.

Cervical alæ present, coarsely striated. Body bent ventrally anteriorly. Lips with pulp forming two deeply separated anterior lobes and an unpaired internal lobe. Interlabia absent. Œsophagus with a distinct muscular bulb posteriorly. Tail of male with a terminal digitiform appendage, marked off by a constriction. On each side a group of five postanal papillæ on the terminal appendage (two subdorsal, one lateral, two subventral), one double subventral papilla between the cloaca and the base of the appendage, and about 20 preanal papillæ. Spicules subequal, alate. Vulva towards anterior quarter of body. Unpaired portion of uterus

relatively long. Coils of female genital tubes extend throughout almost the whole length of the body. Eggs globular or subglobular, with thin shells, the surface of which is pitted. Adult worms chiefly in the small intestine of carnivorous mammals.

Genotype :—*Toxocara canis* (Werner, 1782).

Key to Species.

Parasite of dog tribe
Parasite of cat tribe
Parasite of elephant

canis, p. 59.
mystax, p. 60.
elephantis, p. 60.

1. *Toxocara canis* (Werner, 1782) Stiles, in Stiles and Hassall, 1905. (Fig. 18.)

Synonyms :—*Lumbricus canis* Werner, 1782; *Ascaris vulpis* Frölich, 1789; *Ascaris triquetra* Schrank, 1790; *Fusaria triquetra* Zeder, 1800; *Ascaris marginata* Rudolphi, 1802; *Belascaris marginata* Railliet and Henry, 1911; *Belascaris vulpis* Railliet and Henry, 1911.

Hosts :—This species, which is a cosmopolitan parasite of dogs, is recorded in India from the following animals: dog,

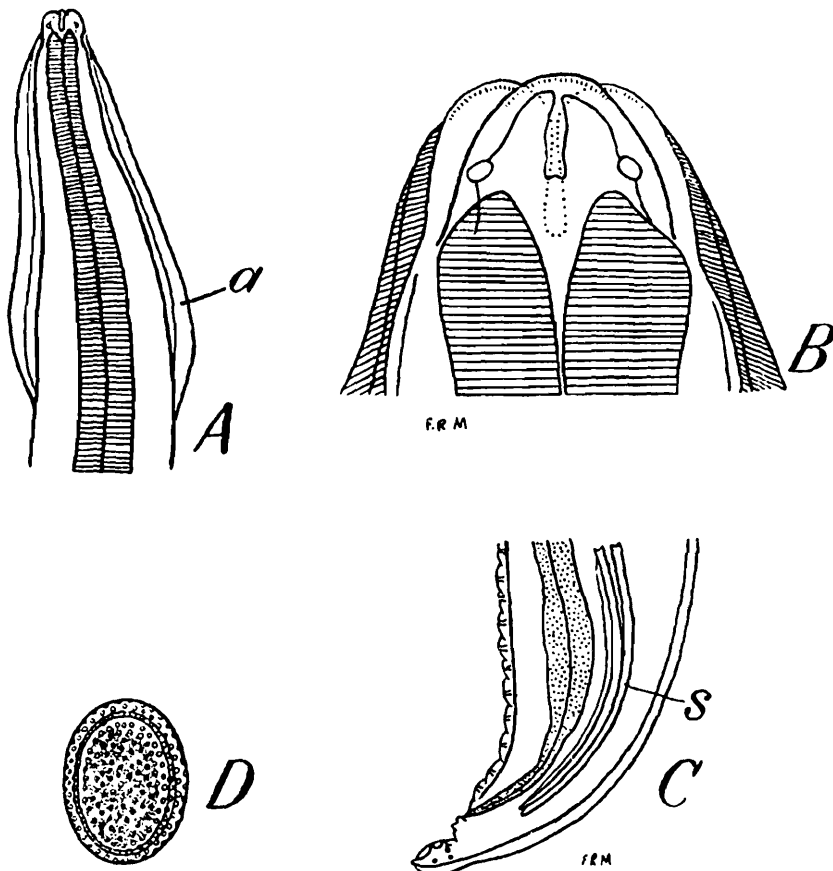

Fig. 18.—*Toxocara canis*. A, anterior end, ventral view; B, lips, dorsal view; C, posterior end of male, lateral view; D, egg. *a.*, cervical ala; *s.*, spicules. (From Baylis, after Yorke and Maplestone.)

Punjab, common (Gaiger), Calcutta (?) (Baylis and Daubney), Colombo, Ceylon (v. Linstow)*; jackal (*Canis aureus*), Indian wolf (*Canis pallipes*) and Indian fox (*Vulpes bengalensis*), Zoological Gardens, Calcutta (Baylis and Daubney).

This species reaches a length of 50–100 mm. in the male and 50–180 mm. in the female. The cuticular striations are 9–37 μ apart. The anterior lobes of the pulp of the lips are digitiform, tapering and convergent. The cervical alæ are long and narrow, and diminish gradually in width posteriorly. The spicules of the male are about 0.75–1 mm. long. The eggs measure about 0.075–0.08 mm. in diameter.

2. *Toxocara mystax* (Zeder, 1800.)

Synonyms:—*Ascaris cati* Schrank, 1788 (part); *Fusaria mystax* Zeder, 1800; *Ascaris mystax* Rudolphi, 1802; *Belascaris mystax* Castellani and Chalmers, 1910; *Belascaris cati* Railliet and Henry, 1911; ? *Ascaris globulus* v. Linstow, 1899.

Hosts:—This is a common parasite of the cat tribe all over the world. In India it has been recorded from the following: domestic cat, Punjab, common (Gaiger), Calcutta (?) (Baylis and Daubney); Siamese domestic cat, tiger (*Felis tigris*), jungle cat (*F. chaus*), fishing cat (*Felis viverrina*) and leopard cat (*F. bengalensis*), all in the Zoological Gardens, Calcutta (Baylis and Daubney); leopard (*F. pardus*), Wirawila, Ceylon (v. Linstow) and in the Zoological Gardens, Calcutta (Baylis and Daubney).

The male measures about 30–70 mm., the female 40–108 mm. The cuticular striations are 10–37 μ apart. The pulp of the lips has two long, digitiform anterior lobes. The cervical alæ are relatively broad, increasing to a maximum width towards their posterior ends and then diminishing rather suddenly. The transverse striations on the alæ are very conspicuous. The spicules of the male are much longer than in *T. canis*. They are slightly unequal and measure 1.6–2 mm. The eggs have a diameter of 0.065–0.075 mm.

3. *Toxocara elephantis* (Rud., 1819).

Synonyms:—*Strongylus elephantis* Rudolphi, 1819; *Strongylus elephantis indici* Diesing, 1851; *Ascaris lonchoptera* Diesing, 1851; “*Ascaris elephantis* Jackson” Diesing, 1851; *Strongylus elephantis* Cobbold, 1879; *Belascaris lonchoptera* Leiper, in Khalil, 1922.

Host:—Indian elephant. The worm does not appear to have been actually observed in India. The two records

* v. Linstow's record of “*Ascaris mystax*” from a “young sucking puppy” probably refers to this species.

apparently referring to its occurrence concern elephants in captivity, one in the United States of America, the other in Europe.

This species is very imperfectly known, only the female having been described, and that very inadequately. Jackson (1847) records "a small species of *Ascaris*" "from the gall-ducts of a young East-Indian Elephant that died in this city [Boston, U.S.A.]." He states that immense numbers of the worms were found in the ducts, and a few in the duodenum. He gives no description of the worm, nor does he name it. Diesing (1851) gives a very brief description of the female specimens originally referred to by Rudolphi, which were in the Vienna Museum and had been collected from the bile-ducts of an Indian elephant at Geneva. Diesing recognized that the worm was not a Strongyle but an Ascarid, and changed its name to *Ascaris lonchoptera*. In an addendum he also refers to Jackson's specimens, under the heading "*Ascaris Elephantis* Jackson." It seems probable that this is not intended as a name, since Jackson, as already stated, did not give the worm a name, and it seems clear that Diesing considered the species identical with his *Ascaris lonchoptera*. In 1857 Diesing refers again to *A. lonchoptera*, adding nothing to his former description, but giving some figures. von Drasche (1883), who re-examined the original specimens, quotes Diesing's diagnosis and adds to it some observations on the structure of the lips, and a new figure, making it quite clear that the form in question is an Ascarid.

Khalil (1922, *b*) states that Leiper also examined the same specimens in the Vienna Museum and came to the conclusion that they belonged to the genus *Belascaris*. If this is so, since *Belascaris* is a synonym of *Toxocara*, the species must be referred to the latter genus, and, since the earliest specific name applied to it was *elephantis* Rudolphi, it seems legitimate to emend this obvious *lapsus* (as was, in effect, done by Diesing and by Cobbold) to *elephantis*, and to name the worm *Toxocara elephantis*.

Putting together the information given by Diesing and by v. Drasche, the following is all that can be said at present of the morphology of the worm :—

Length of female, three inches or more. Thickness three-quarters of a line ($1/16$ in.). Body tapering anteriorly and provided with cervical alæ. Lips oval, their pulp having a pair of deeply-separated anterior lobes and an unusually broad unpaired lobe, which is slightly emarginate in front. Fine dentigerous ridges present on the margins of the lips. In the middle of the lip a short groove, open behind. Tail conical and pointed. Male undescribed.

5. Genus **TOXASCARIS** Leiper, 1907.

Cervical alæ present, finely striated. Body bent dorsally anteriorly. Lips as in *Toxocara*, but with the anterior lobes marked off from the main pulp by a deep groove and broad and bilobed at their extremities. Interlabia absent. Œsophagus without bulb. Tail of male conical, without digitiform appendage. On each side a group of papillæ near the tip of the tail. A double subventral papilla between these and the cloaca, and a row of 25 or more papillæ, most of which are preanal. Spicules subequal, non-alate. Vulva at about the anterior third of the body. Unpaired portion of uterus relatively short. Coils of female genital tubes lie between vulva and posterior end of body. Eggs subglobular, with thick, smooth shells. Adult worms in the small intestine of carnivorous mammals.

Genotype :—*Toxascaris leonina* (v. Linstow, 1902).

Key to Species.

Parasite of cat and dog tribes
Parasite of bears.

leonina, p. 62.
transfuga, p. 63.

1. **Toxascaris leonina** (v. Linst., 1902) Railliet and Henry, 1911. (Fig. 19.)

Synonyms :—*Ascaris cati* Schrank, 1788 (part); *Ascaris leptoptera* Rudolphi, 1809 (part); *Ascaris leonina* v. Linstow, 1902; *Toxascaris marginata* of Leiper, 1907; *Ascaris canis* of Glaue, 1909; *Toxascaris limbata* Railliet and Henry, 1911; ? *Ascaris crenulata* Bremser, 1824; ? *Ascaris microptera* Rudolphi, 1819; ? *Toxascaris microptera* Railliet and Henry, 1911.

Hosts :—Taylor (1924) has shown that no morphological difference can be recognized between *Toxascaris limbata* of dogs and *T. leonina* of cats. It was formerly supposed that these were two distinct species, the former being a parasite of Canidæ, the latter of Felidæ. Both have been recorded from a considerable variety of hosts and from many parts of the world. On the view that all the Indian records refer to one and the same species, the following is a list of hosts :—Lion (*Felis leo*), tiger (*F. tigris*), leopard (*F. pardus*), ounce, or snow leopard (*F. uncia*), fishing cat (*F. viverrina*), leopard cat (*F. bengalensis*), hunting leopard, or cheetah (*Cynæxurus jubatus*), ? Indian fox (*Vulpes bengalensis*), probably all in the Zoological Gardens, Calcutta (Baylis and Daubney).

The male is about 20–70 mm. long, the female about 30–100 mm. The body is relatively slender. The cuticular striations are 4–14.6 μ apart. The cervical alæ are long and narrow, and decrease gradually in width behind.

The caudal end of the male bears on each side a group of five papillæ near the tip of the tail (two subdorsal, one lateral, two subventral), a double subventral papilla between these and the cloaca, and a row of 25 or more papillæ, the first of which is behind the cloaca, the second at the level of the cloacal opening and the rest preanal. The preanal papillæ

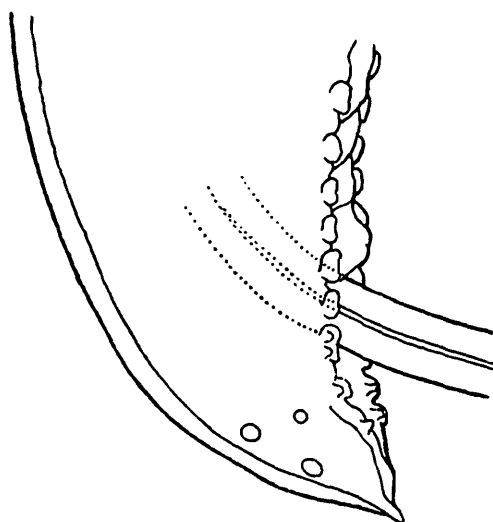

Fig. 19.—*Toxascaris leonina*. Posterior end of male; lateral view. (After Taylor.)

are conspicuous near the cloaca, but become smaller anteriorly. The spicules are slightly unequal and measure 0.7–1.5 mm. in length.

The tail of the female is sharply pointed. The eggs measure 0.06–0.085 mm. in diameter.

2. *Toxascaris transfuga* (Rud., 1819) Baylis and Daubney, 1922. (Figs. 20 & 21.)

Synonym :—*Ascaris transfuga* Rudolphi, 1819.

Hosts :—In India this species has been recorded from the following animals :—Himalayan black bear (*Ursus torquatus*), *Ursus* sp., sloth-bear (*Melursus ursinus*) and red cat-bear (*Aelurus fulgens*), in the Zoological Gardens, Calcutta (Baylis and Daubney). It also occurs in the brown bear and polar bear in other parts of the world.

The male attains a length of 92 mm. and a thickness of 1.8 mm. The length of the female is 115–240 mm., and its maximum thickness 2.8–4.5 mm. The cuticular striations are 8.3–11 μ apart. The anterior end of the body is usually curved towards the dorsal side. The head measures 0.5–0.6 mm. in diameter. The lips are roughly semicircular in outline, and each carries two papillæ, those of the dorsal lip being equal and symmetrically placed, while those of each ventro-lateral lip are rather unequal and asymmetrical,

the papilla towards the ventral margin being large, the more lateral papilla smaller and situated slightly further forward. The pulp of each lip sends out five processes, two in a transverse direction, near the ends of which are the papillæ, and three anteriorly. Of the anterior processes two form large, paired lobes which expand slightly and have a shallow longitudinal groove on their inner surfaces distally. The third is the unpaired median lobe, which appears to end in short rays that spread out beneath the cuticle of the inner surface. The dentigerous ridges are composed of relatively large teeth. The cervical alæ are well developed and 3–5 mm. long. The œsophagus is club-shaped and very stout posteriorly (0.5–0.95 mm.), and measures 4–5 mm. in length.

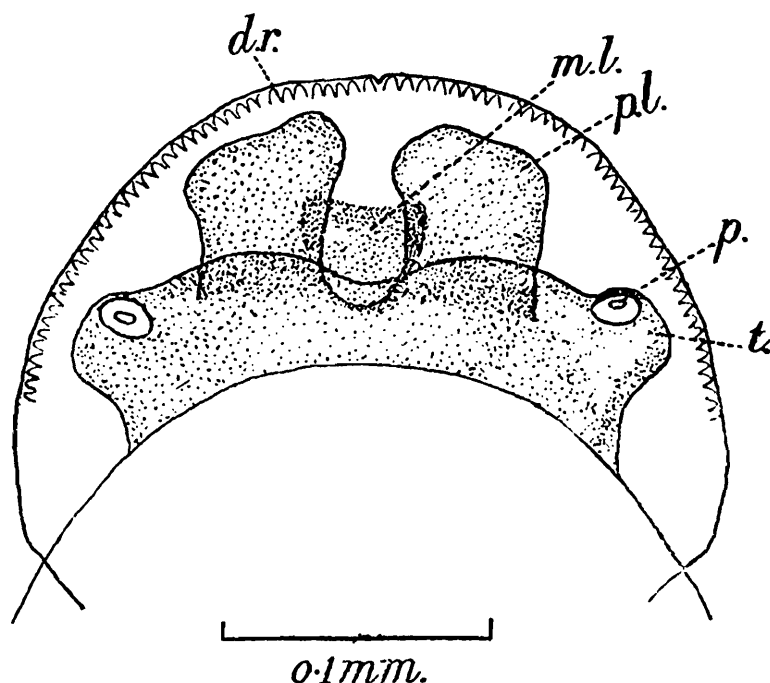

Fig. 20.—*Toxascaris transfuga*. Dorsal lip, viewed from exterior. *d.r.*, dentigerous ridge; *m.l.*, median lobe of pulp; *p.*, papilla; *p.l.*, paired anterior lobe; *t.*, transverse process of pulp. (After Baylis and Daubney.)

The caudal end of the male is curved ventrally, but the extremity is usually recurved towards the dorsal side. The tail measures 0.4–0.5 mm. in length and is bluntly conical, but ends in a short spike which has a small terminal papilla-like button. The caudal papillæ consist of (1) four pairs near the tip of the tail (two small and subventral, two larger and more lateral); (2) an isolated lateral pair; (3) a pair of large double papillæ; (4) thirty or more pairs of papillæ extending for a considerable distance in front of the cloaca. This last series begins just behind the cloaca, and the papillæ in each row are at first close together and tend to form two alternating rows, but further forward the rows become single

and the papillæ wider apart. The spicules are very short and stout, measuring about 0.53–0.65 mm. in length and 0.054 mm. in thickness. Their surfaces are covered with small granulations.

The tail of the female is bluntly conical and almost rounded posteriorly, but has a small papilla-like termination, as in the male. It measures up to 1.4 mm. in length. The vagina is narrow and convoluted, and measures about 4 mm. in length.

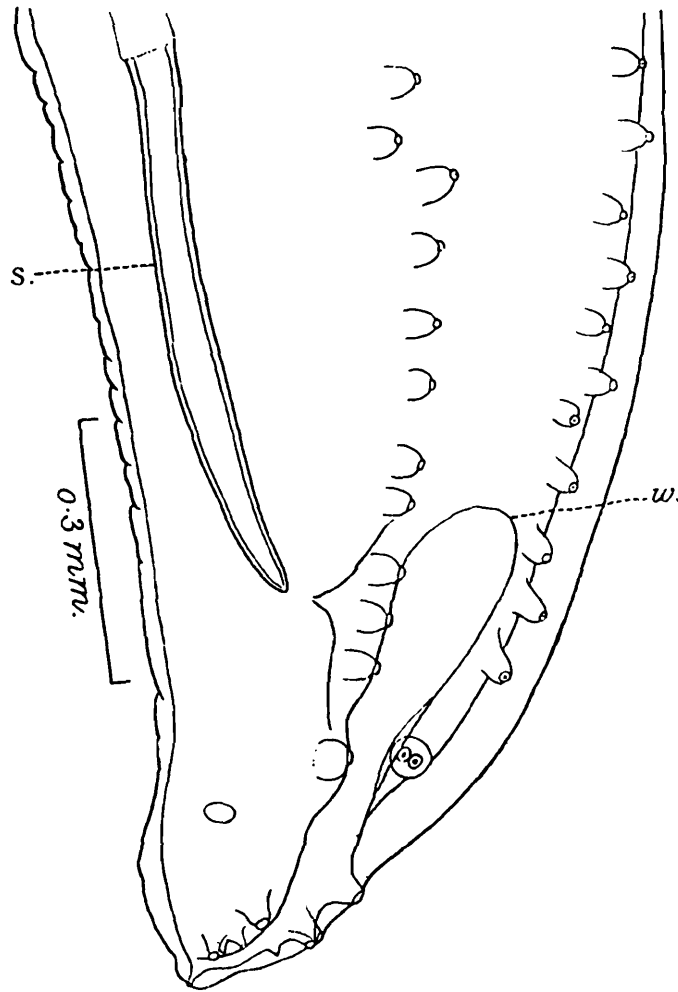

Fig. 21.—*Toxascaris transfuga*. Posterior end of male; ventro-lateral view. *s.*, right spicule; *w.*, wall of depression surrounding cloacal aperture. (After Baylis and Daubney.)

It leads into a uterine chamber, not exceeding 5 mm. in length, which gives off posteriorly the two uterine branches. The eggs are oval and measure 0.077–0.09 × 0.06–0.075 mm. When ready for laying, the smooth shell appears to become covered, as in *Ascaris lumbricoides*, with an irregular coat of a yellowish albuminous substance, which possibly led Dujardin to describe them as punctulated.

Subfamily ANISAKINÆ Railliet and Henry, 1912,
emend. Baylis, 1920.

Œsophagus may or may not be divided into an anterior muscular portion and a posterior ventriculus of different histological structure, or a muscular bulb. When a ventriculus is absent, and frequently when it is present, there is an anterior cæcum springing from the intestine and lying parallel to the œsophagus. A posterior appendix, or occasionally several such appendices, some of which may be directed anteriorly, may also be developed in connection with the ventriculus. Adult worms in the alimentary canal of vertebrates, mainly of aquatic or fish-eating animals. Life-history, where known, indirect, involving an intermediate host, most commonly a fish.

Key to Genera.

Ventriculus without appendix.	1.	
Ventriculus with an appendix, or several appendices	4.	
1. An intestinal cæcum present	2.	
Intestinal cæcum absent	3.	
2. Dentigerous ridges present; ventriculus oblong		PORROCÆCUM, p. 69.
Dentigerous ridges absent in adult, but tooth-like structures present on inner surfaces of lips; ventriculus a sub-globular bulb.		DUJARDINIA, p. 95.
3. Dentigerous ridges present		PARANISAKIS, p. 92.
Dentigerous ridges absent		BELANISAKIS, p. 66.
4. Ventriculus with a single appendix	5.	
Ventriculus with several appendices	7.	
5. Intestinal cæcum absent		RAPHIDASCARIS, p. 67.
An intestinal cæcum present	6.	
6. Cuticle with transverse rings of spines		GOEZIA, p. 107.
Cuticle without spines		CONTRACÆCUM, p. 79.
7. A longitudinally-folded collar present behind the lips		TYPHLOPHOROS, p. 104.
No longitudinally-folded collar behind the lips	8.	
8. Interlabia and interlabial grooves present.		MULTICÆCUM, p. 100.
Interlabia and interlabial grooves absent		POLYCÆCUM, p. 102.

1. Genus **BELANISAKIS** Maplestone, 1932.

Lips without dentigerous ridges. Interlabia present. Œsophagus with an oblong ventriculus. Œsophageal appendix and intestinal cæcum absent. An accessory piece present in the genotype. Adult worms parasitic in birds.

Genotype :—*Belanisakis ibidis* Maplestone, 1932.

1. *Belanisakis ibidis* Maplestone, 1932.

Host :—Black-headed ibis (*Threskiornis [Ibis] melanocephalus*) (intestine) ; Zoological Gardens, Calcutta.

The male measures 23 mm. in length and about 0.54 mm. in maximum thickness, the female 34 mm. and 0.71 respectively. Broad cervical alæ are present, extending nearly to the level of the posterior end of the œsophagus. They have a maximum width (in the male) of 0.16 mm. In the male the œsophagus measures 2.7 mm. in length, the ventriculus 0.79 mm. ; in the female these organs measure 3.1 mm. and 1 mm. respectively.

The tail of the male is 0.24 mm. long. It is narrowed rather suddenly a little behind the cloacal aperture, and slightly swollen again before the tip, which is bluntly conical. The postanal papillæ consist of a pair of double papillæ a little behind the cloacal aperture and two pairs of small papillæ near the tip of the tail. There is a series of 18 papillæ extending forward from the cloacal aperture on each side, the most posterior papilla being adanal. These papillæ become more widely separated anteriorly, and extend to a distance of about 4 mm. from the posterior extremity. The spicules are stout, equal and bluntly pointed, and measure 0.5 mm. in length. There is an accessory piece in the form of a chitinoid nodule, 0.06 mm. long.

The tail of the female measures 0.79 mm. in length, and is tapering and pointed. The vulva is situated at a distance of 11.7 mm. from the anterior end. The vagina runs posteriorly for a distance of about 2 mm. "A short portion of the vagina at its commencement is divided off from the rest of the organ by a valvular structure, and posteriorly, just before dividing into the two uteri, it takes a close S-shaped curve." The uterine branches extend posteriorly almost as far as the anus before passing into the ovarian tubes, and the latter run forward with a very convoluted course to within a short distance of the vulva. The eggs measure 0.06×0.048 mm.

2. Genus **RAPHIDASCARIS** Railliet and Henry, 1915.

Lips without dentigerous ridges. Interlabia present. Œsophagus with a small ventriculus, from which springs a posterior appendix. No intestinal cæcum. Adult worms in the stomach and intestine of fishes.

Genotype :—*Raphidascaris acus* (Bloch, 1779).

1. *Raphidascaris diadonis* Thwaite, 1927. (Fig. 22.)

Host :—*Diodon hystrix* ; Negapatam, South India.

The male measures 38–52 mm. in length and about 1 mm. in maximum thickness, the female 45–62 mm. and about 1.5 mm. respectively. The body is more tapering anteriorly than posteriorly, and the cuticle is finely striated. The lips are 0.24–0.34 mm. long and 0.18–0.25 mm. wide. The interlabia are 0.092–0.138 mm. long. The œsophagus is 4.9–6.7 mm. long, excluding the ventriculus, which measures 0.215–0.365 mm. in length and 0.3–0.56 mm. in width. The œsophageal appendix is 0.86–1.46 mm. long. The cervical

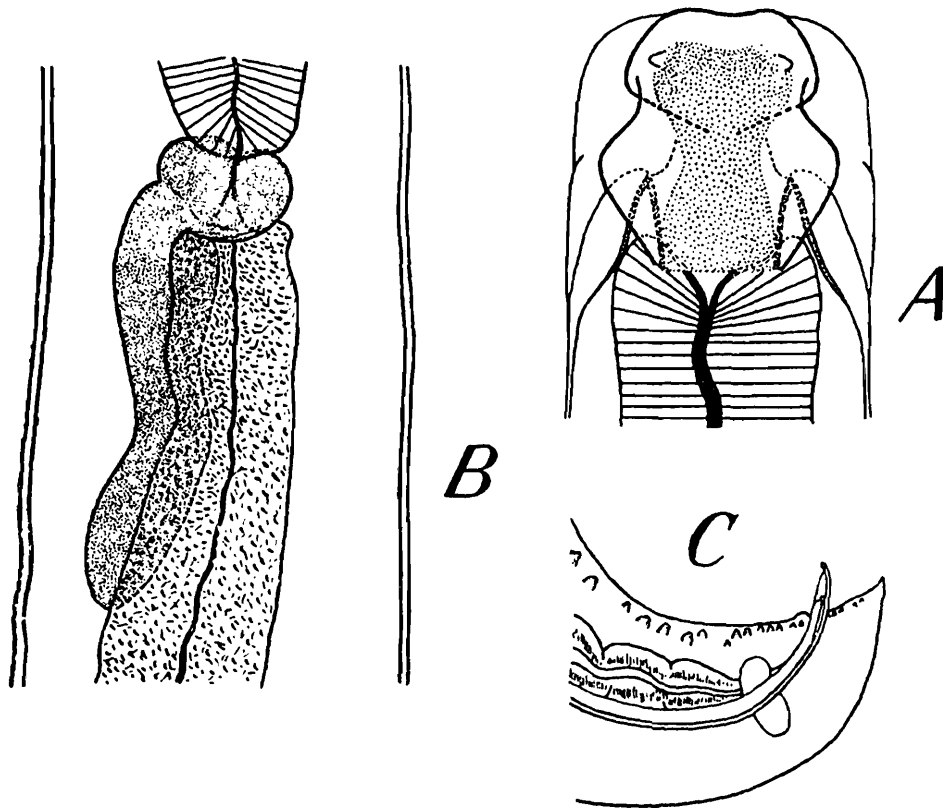

Fig. 22.—*Raphidascaris diadonis*. A, head, dorsal view ; B, portion of œsophagus and intestine, showing ventriculus and appendix ; C, posterior end of male, lateral view. (After Thwaite.)

papillæ and excretory pore are at about 1 mm. from the anterior end, and the nerve-ring is about 0.1 mm. in front of them.

The tail of the male is conical and 0.15–0.23 mm. long. Its tip may be sharply pointed and apparently smooth, or may be covered with minute spines. "There are about three to six pairs of minute postanal papillæ and about 30 pairs of preanal papillæ. These latter appear to vary somewhat in number in the various individual worms, the numbers ranging from 23 to 35 on each side. In the vicinity

of the anus the papillæ are extremely small, but become progressively larger as the distance from the anus increases. A median preanal papilla is usually present, but apparently not constantly so." The spicules are equal and alate, and measure 0.276–0.35 mm. in length. They terminate distally in small knobs.

The tail of the female is conical and 0.46–0.54 mm. long. The vulva is situated at about the anterior third of the body. The average dimensions of the eggs are 0.063 × 0.056 mm.

3. Genus **PORROCÆCUM** Railliet and Henry, 1912.

Synonym :—*Terranova* Leiper and Atkinson, 1914.

Lips with dentigerous ridges. Interlabia usually present. Œsophagus with an oblong ventriculus, which is short in the genotype and in some other species, but in others is often long and bent so as to open into the intestine laterally. An intestinal cæcum present. No œsophageal appendix. An accessory piece (gubernaculum) is rarely present in the male. Adult worms in intestine or stomach of birds, reptiles, fishes and marine mammals.

Genotype :—*Porrocæcum crassum* (Desl., 1824).

Key to Species.

Parasites of birds	1.
Parasites of fishes	4.
1. Parasite of ducks.	<i>crassum</i> , p. 69.
Parasites of birds of prey.	2.
Parasites of herons, egrets, cranes, &c.	3.
2. Pulp of dorsal lip with two bifurcated anterior lobes	<i>depressum</i> , p. 70.
Pulp of dorsal lip with two rounded anterior lobes, each bearing a flattened and expanded process	<i>angusticolle</i> , p. 71.
3. Male with about 15 pairs of preanal papillæ.	
Spicules about 1.25 mm. long	<i>ardeæ</i> , p. 73.
Male with five pairs of preanal papillæ.	
Spicules about 0.5 mm. long	<i>reticulatum</i> , p. 74.
4. Parasite of sawfish	<i>pristis</i> , p. 75.
Parasite of shark	<i>galeocerdonis</i> , p. 77.

1. **Porrocæcum crassum** (Desl., 1824) Railliet and Henry, 1912.

Synonym :—*Ascaris crassa* Deslongchamps, 1824.

Hosts :—This species occurs in ducks, both wild and domestic, in Europe and other parts of the world, and has also been recorded from the guineafowl. In India it has been recorded by Baylis and Daubney from a domestic duck at Bombay.

The male measures 12–30 mm. in length, the female 43–53 mm. The greatest thickness is 0.5–1.2 mm. in the

male and up to 2.2 mm. in the female. The ventriculus is very short and almost globular. The tail of the male is about $1/46$ of the total length and is conical, with a terminal spike. The spicules are 0.52–0.7 mm. long and are alate, with blunt tips.

The tail of the female is pointed and about $1/55$ of the total length. The vulva is slightly behind the middle of the body, dividing it in the proportion of about 13:11. The eggs are globular and have a diameter of about 0.1 mm.

2. *Porrocæcum depressum* (Zeder, 1800) Baylis, 1920.
(Fig. 23.)

Synonyms:—*Fusaria depressa* Zeder, 1800; *Ascaris depressa* Rudolphi, 1809.

Hosts:—This is a common parasite of birds of prey in many parts of the world. It has been recorded in a large

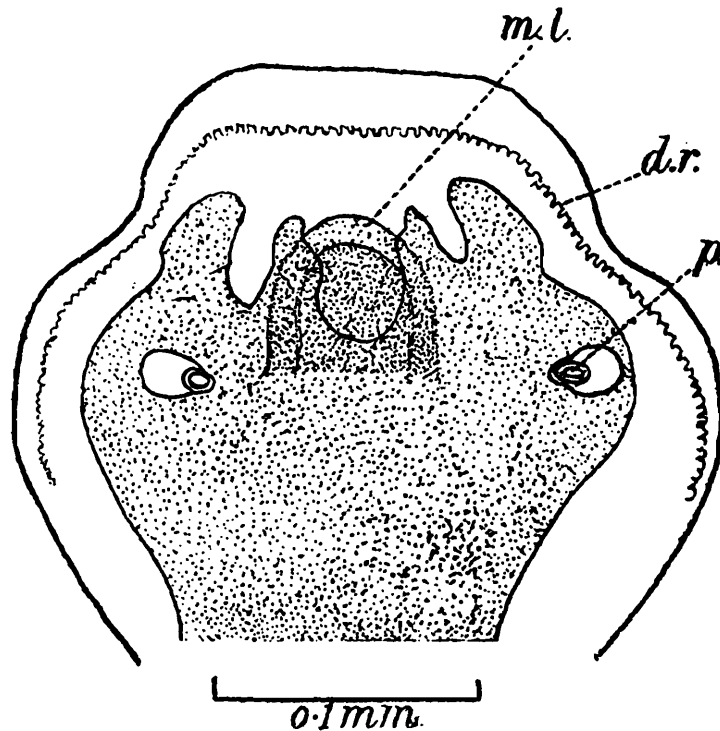

Fig. 23.—*Porrocæcum depressum*. Dorsal lip of female, viewed from exterior. *d.r.*, dentigerous ridge; *m.l.*, median lobe of pulp; *p.*, papilla. (After Baylis and Daubney.)

number of species of hawks, eagles and vultures. In India it has been recorded by Baylis and Daubney from the cinereous vulture (*Ægyptius* [*Vultur*] *monachus*). Its intermediate hosts are, in all probability, shrews and moles, larval forms found in these animals, and originally described by Rudolphi in 1802 as *Ascaris incisa*, probably belonging to this species.

This is a rather slender form. The male measures 24–100 mm. in length, the female 30–112 mm. The pulp of the dorsal lip has two bifurcated anterior lobes and a large median lobe which projects anteriorly beyond the “saddle” separating these lobes. The interlabia are small.

The tail of the male has a conical terminal prolongation bearing five pairs of small papillæ. There is also a pair of large, double papillæ behind the cloacal aperture. The preanal papillæ consist of about 17 pairs.

The vulva is situated a little in front of the middle of the body, dividing the latter in the proportion of about 5 : 6. The eggs have finely punctate shells, thickened at the poles.

3. *Porrocæcum angusticolle* (Molin, 1860) Baylis and Daubney, 1922. (Figs. 24 & 25.)

Synonym :—*Ascaris angusticollis* Molin, 1860.

Hosts :—Like *P. depressum*, this species has been recorded from a variety of species of birds of prey, not only in India

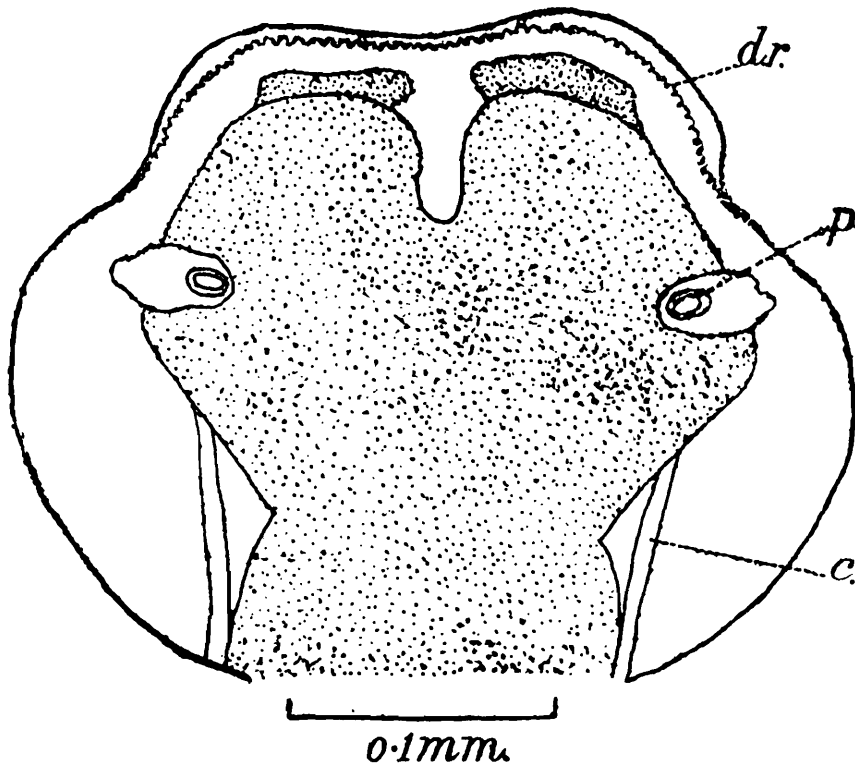

Fig. 24.—*Porrocæcum angusticolle*. Dorsal lip of female, viewed from exterior. *c.*, cuticular ridge; *d.r.*, dentigerous ridge; *p.*, papilla. (After Baylis and Daubney.)

but in Europe and Africa. Its Indian hosts include the kite (*Milvus migrans govinda*) and a vulture, both recorded by Baylis and Daubney, the latter from Satpara, Chilka Lake, Orissa. The British Museum (Natural History) also possesses a specimen obtained from a “fish-hawk” at Poona.

Relatively to its length this is a somewhat more slender form than *P. depressum*. The male measures up to 55 mm. in length and 1.1 mm. in thickness, the female 40–90 mm. and 1.5 mm. respectively. The dorsal lip is almost hexagonal, with rounded angles. The pulp sends out two rounded anterior lobes, from the inner surfaces of which spring two flattened and expanded processes. Towards the base of the lip there is on either side a rather conspicuous longitudinal ridge or fold of cuticle. There are small, triangular interlabia. The cuticular striations on the body are about $17\ \mu$ apart. Anteriorly the body tapers to form a long, slender neck. The head is small, its diameter being about 0.24–0.26 mm. There is a slight constriction at its junction with

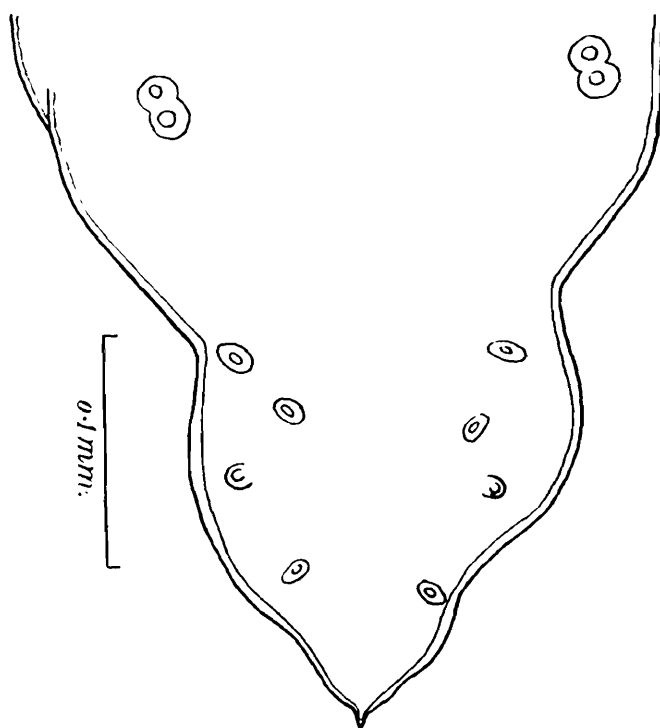

Fig. 25.—*Porrocæcum angusticolle*. Posterior end of male; ventral view. (After Baylis and Daubney.)

the neck. The œsophagus is 4.8 mm. long, including a short, oblong ventriculus measuring 0.6 mm. in length. The intestinal cæcum is 2.7–3 mm. long. The nerve-ring is situated at about 0.85 mm. from the anterior extremity. At about 1.7 mm. from the anterior end there is a pair of large, sessile cervical papillæ.

The tail of the male is conical and measures 0.39 mm. in length. About half-way between the cloaca and the tip of the tail there is a distinct constriction. There are four pairs of papillæ on the portion behind the constriction, a pair of double papillæ just behind the cloaca and about 20 pairs of preanal papillæ, the most posterior of which is

just in front of the cloacal aperture. The spicules are non-alate and equal, measuring 0.95 mm. in length.

The tail of the female is blunter than that of the male and measures 0.7 mm. in length. There is a pair of caudal papillæ at 0.2 mm. from the tip. The vulva is situated in the anterior half of the body, dividing the latter in the proportion of 3 : 5. The eggs measure 0.085–0.093 × 0.058–0.074 mm.

4. *Porrocæcum ardeæ* (Frölich, 1802). (Fig. 26.)

Synonyms :—*Ascaris ardeæ* Frölich, 1802, *nec* Smith, Fox and White, 1908 ; *Ascaris serpentulus* Rudolphi, 1809 (not *A. ardearum* Rud., 1819).

Hosts :—Herons and cranes in various parts of the world ; also recorded from the flamingo. Recorded in India from the common crane (*Grus grus*) and demoiselle crane (*Anthropoides virgo*) in the Calcutta Zoological Gardens (Baylis and Daubney).

The size of this species appears to be very variable. The male usually measures about 40–55 mm. in length and 1 mm.

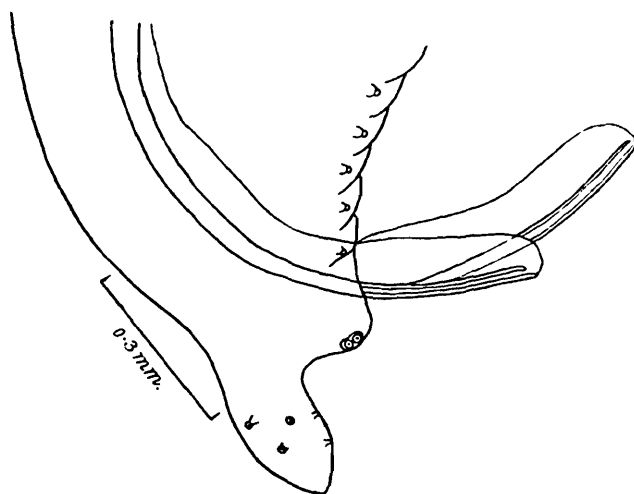

Fig. 26.—*Porrocæcum ardeæ*. Posterior end of male ; lateral view. (After Baylis and Daubney.)

in thickness ; the female may measure up to 160 mm. in length, and its thickness varies between 2 and 4 mm. Specimens from cranes appear to have a relatively shorter and stouter build than those from herons. The pulp of the dorsal lip has two bifurcated anterior lobes. The interlabia are relatively large. There is a pair of lateral alæ extending throughout the length of the body, and particularly wide for a distance of about 3 mm. from the head. The œsophagus, in a specimen 55 mm. long, measures 3.4 mm., the ventriculus 0.4 mm. and the intestinal cæcum 3 mm.

The tail of the male is suddenly constricted in the middle so as to form a finger-shaped terminal appendage. This bears five pairs of papillæ (two ventral, two subdorsal, one lateral). On the anterior portion of the tail there is a pair of large, double papillæ, directed posteriorly. The preanal papillæ are arranged in regular series of about 15 on each side. The spicules are equal, measuring 1.25 mm. in a specimen of moderate size, and have very broad alæ.

The eggs measure about 0.1×0.078 mm., and the surface of their shells has a reticulate pattern.

5. *Porrocæcum reticulatum* (v. Linstow, 1899) Baylis and Daubney, 1922. (Fig. 27.)

Synonyms:—*Ascaris reticulata* v. Linstow, 1899; ? *Ascaris ardeæ* Smith, Fox and White, nec Frölich, 1802.

Hosts:—Hérons and egrets in various parts of the world. The species has been recorded in India from the eastern purple heron (*Ardea purpurea manillensis*), the night heron (*Nycticorax nycticorax* [*griseus*]) and an egret (species unknown) in the Zoological Gardens, Calcutta (Baylis and Daubney).

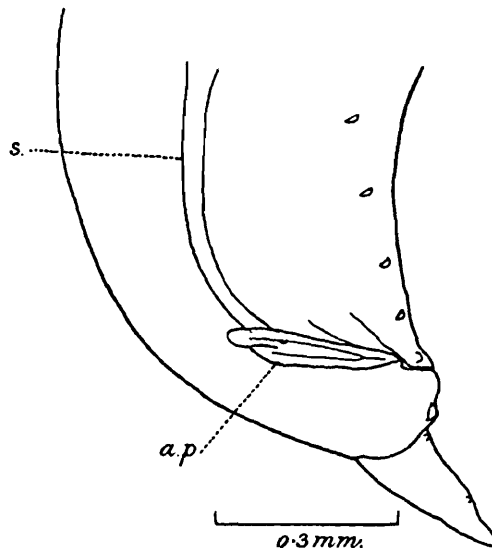

Fig. 27.—*Porrocæcum reticulatum*. Posterior end of male; lateral view. *a.p.*, accessory piece; *s.*, right spicule. (After Baylis and Daubney.)

The description of this species has been considerably amplified by Hsü (1933), on the basis of Chinese material from *Nycticorax nycticorax*. It is a relatively slender form, the male measuring up to about 56 mm. in length and 0.81 mm. in maximum thickness, the female up to about 87 mm. and 1.6 mm. respectively. The dorsal lip is about 0.35 mm. long and 0.28 mm. wide at its base. Its pulp has two convergent anterior lobes. There are well-developed interlabia. Cervical alæ are absent. According to Hsü, the

œsophagus, excluding the ventriculus, is about 2.2–3.8 mm. long in the male and about 5.5–6.8 mm. in the female. The ventriculus is oblong and relatively short, measuring 0.28–0.4 mm. in length in the male and 0.57–0.66 mm. in the female. The intestinal cæcum is well developed and extends for a considerable part of the length of the œsophagus. Hsü gives its length as 1.64–1.8 mm. in the male and 4.23–4.67 mm. in the female. The nerve-ring is situated at 0.46–0.71 mm. from the anterior extremity in the male and at 0.9 mm. in the female.

The tail of the male is 0.27–0.36 mm. long, and is constricted somewhat in front of its middle so as to form a finger-like terminal appendage. The latter bears two pairs of small subventral papillæ and also, according to Hsü, a lateral pair. Just in front of the constriction there is a pair of large papillæ which are stated by Hsü to have double nerve-endings. Previous authors have described the presence of five pairs of preanal papillæ, but Hsü finds six or seven pairs. The spicules are tubular, non-alate and 0.35–0.57 mm. long. They have a rough, granular appearance. There is a large, smooth accessory piece, or gubernaculum, which was first noted by Baylis and Daubney (1922), in whose material it measured about 0.3 mm. in length. According to Hsü it is 0.13–0.23 mm. long.

The tail of the female is about 1 mm. long, and bears a pair of lateral papillæ near the tip. The eggs are almost spherical and measure 0.107–0.112 × 0.086–0.092 mm. The surface of their shells is closely pitted, this giving it the reticulate appearance noted by v. Linstow.

6. *Porrocæcum pristis* Baylis and Daubney, 1922. (Figs. 28–30.)

Host :—Sawfish (*Pristis perrotteti*); Ulubaria, River Hooghly.

The male measures up to 26.6 mm. in length and 0.74 mm. in thickness, the female 34.2 mm. and 1.06 mm. respectively. The diameter of the head is 0.16–0.18 mm. The cuticular striations are 8.7–10 μ apart. The lips are small, and pass into the neck without any constriction at their bases. Each has a narrow, bilobed, anterior process, carrying two small cuticular projections on its inner surface, in addition to a dentigerous ridge composed of minute denticles. The dorsal lip is shorter than the ventro-lateral lips, and has two large papillæ. Each ventro-lateral lip has a large, lozenge-shaped, ventral papilla and a much smaller lateral papilla, situated more anteriorly. Interlabia are absent. The œsophagus, including an oblong ventriculus 0.6–0.78 mm. long, measures 2.3–2.7 mm. in length. The intestinal cæcum is 0.95–1.3 mm.

long. There is a pair of prominent, rounded cervical papillæ at 0.65–0.67 mm. from the anterior extremity. The nerve-ring is situated at 0.46–0.53 mm. from the same point.

Fig. 28.

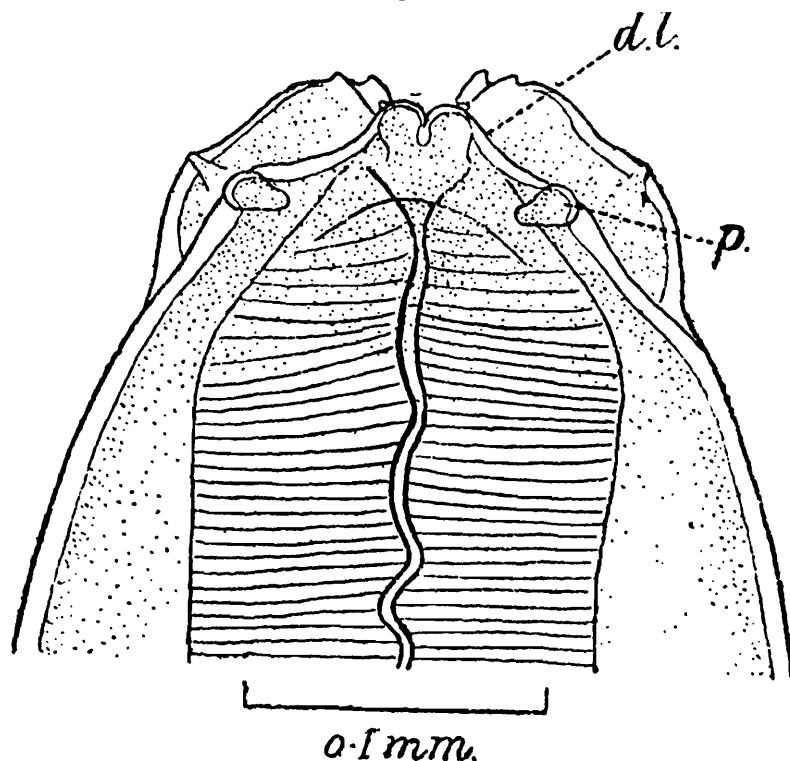

Fig. 29.

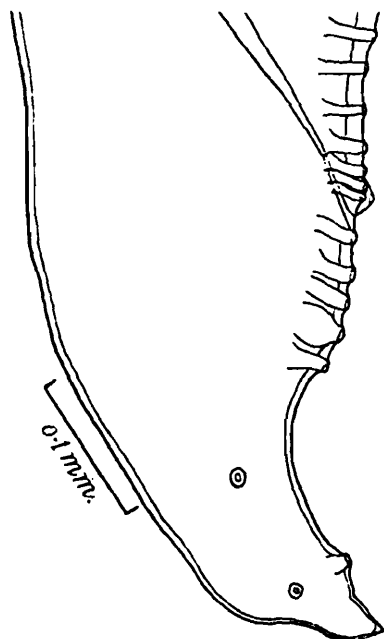

Fig. 30.

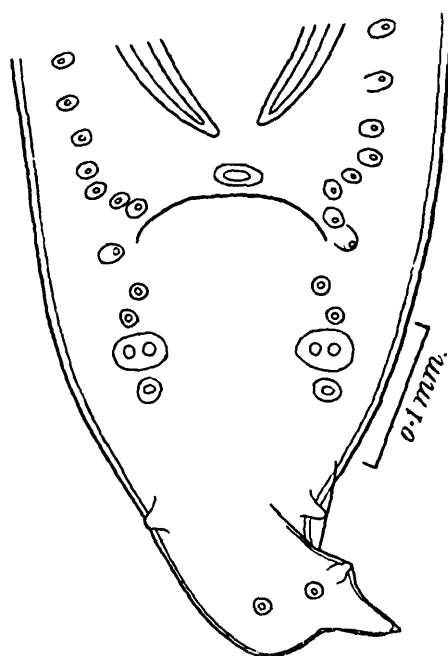

Fig. 28.—*Porrocæcum pristis*. Head of female; dorsal view. *d.l.*, dorsal lip; *p.*, right papilla of same. (After Baylis and Daubney.)

Fig. 29.—*Porrocæcum pristis*. Posterior end of male; lateral view. (After Baylis and Daubney.)

Fig. 30.—*Porrocæcum pristis*. Posterior end of male; ventral view. (After Baylis and Daubney.)

The tail of the male is conical and measures 0.38 mm. in length. It is provided with slight caudal alæ. There are seven pairs of postanal papillæ, the fifth on each side from the posterior end being large and double. The second and third are more laterally placed than the others. There are about 40 pairs of preanal papillæ, beginning with a pair at the corners of the cloacal aperture. There is also a median papilla on the anterior lip of the cloaca. The spicules are equal, non-alate and 0.9 mm. long.

The tail of the female is bluntly conical and measures 0.44 mm. in length. There is a pair of caudal papillæ at 0.162 mm. from the tip. The vulva is somewhat behind the anterior third of the body (at 12.3 mm. from the anterior end in a specimen 34.2 mm. long). The muscular vagina, which runs posteriorly, is only about 0.7 mm. long, expanding in its posterior half to a diameter of 0.19 mm. This swollen portion forms an egg-reservoir, and is followed by a wide unpaired portion of the uterus, about 2 mm. long, which gives off posteriorly the two uterine branches. These run almost straight towards the posterior end. The posterior limit of the coils of the ovarian tubes is about 1.5 mm. from the posterior end. The eggs are spherical and have thin shells measuring 0.0475 mm. in diameter.

7 *Porrocæcum galeocerdonis* Thwaite, 1927. (Fig. 31.)

Host:—A shark (*Galeocерdo tigrinum*); Twynams Paar, Pearl Banks, Ceylon.

This species appears to be extremely closely related to *P. pristis*. The male measures 17.7–32.6 mm. in length and 0.67–0.89 mm. in maximum thickness, the female 22.2–44 mm. and 0.83–1.4 mm. respectively. The body is tapering anteriorly, and bears a pair of cervical papillæ at about 0.6 mm. from the anterior end. A pair of narrow lateral alæ extend from the base of the lips to the posterior third of the body in the male, and to about the level of the vulva in the female. The diameter of the head is about 0.18 mm. Each lip, as in *P. pristis*, has a narrow anterior projection bearing two tooth-like processes and, between these, fine denticles. The dorsal lip has two large papillæ, each ventro-lateral lip a larger ventral and a smaller lateral papilla. The pulp of the dorsal lip forms two rounded anterior lobes. Interlabia are absent. The œsophagus is 2.3–3.1 mm. long, the ventriculus 0.6–0.83 mm. and the intestinal cæcum 1.1–1.8 mm. The nerve-ring is situated a little in front of the cervical papillæ.

The tail of the male is sharply pointed and measures about 0.275 mm. in length. On its ventral surface behind the

cloaca there are a number of small cuticular spines. There are about eight pairs of postanal papillæ, the sixth pair from the posterior end being large and double. The preanal papillæ number 47-70 on each side, and there is also a large, median papilla on the anterior lip of the cloaca. The spicules are equal or subequal, 0.52-0.774 mm. long and rather sharply pointed.

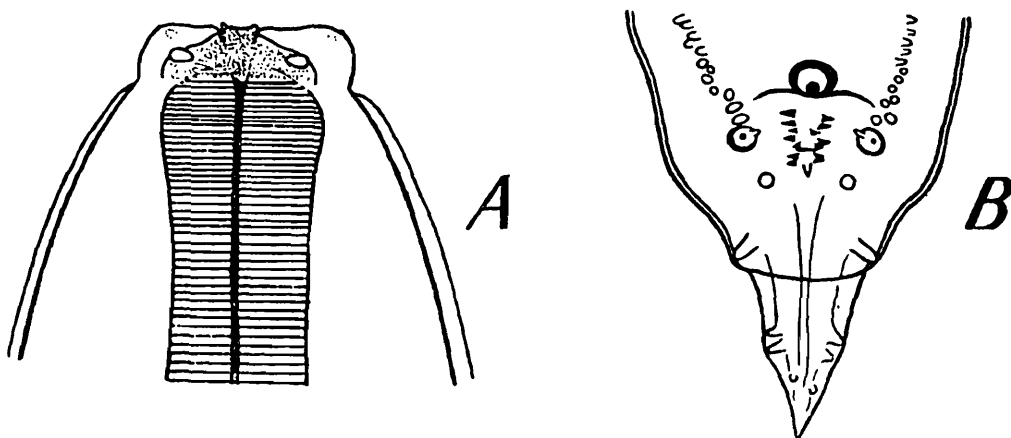

Fig. 31.—*Porrocæcum galeocerdonis*. A, head, dorsal view; B, posterior end of male, ventral view. (After Thwaite.)

The tail of the female is sharply pointed and measures 0.4 mm. The vulva is situated at 8-12.8 mm. from the anterior end, dividing the body in the proportion of 1 : 2.8 to 1 : 3.8. The vagina is about 0.8 mm. long, and its posterior portion is expanded to form an egg-reservoir. The eggs have a diameter of 0.041 mm.

8. *Porrocæcum* sp.

Baylis and Daubney (1923) have recorded larval forms of a species of this genus from the mesentery of a fish, *Otolithus maculatus*. They have also recorded larval forms, which may have belonged to this genus or to *Anisakis*, from the body-cavity of a deep-sea fish, *Dysalotus alcocki* (Marine Survey, Station 315, 705 fathoms), and from either *Callichrous pabda* or *Wallago attu* (part of "L. 33" of Stewart, 1914, p. 179, from Lucknow).

9. *Ascaris quadrata* v. Linstow, 1904 (not 1905).

Host :—*Crocodilus porosus* (stomach); Bolgoda, Ceylon.

From the meagre details given in the description of this form it appears possible that it may belong to the genus *Porrocæcum*. The only character that seems to be against this is the stated absence of dentigerous ridges on the lips. The species does not correspond with *Porrocæcum crocodili* Taylor, 1924, which has been recorded from crocodiles in Africa and Australia, and apparently it is not a *Dujardinia*.

v. Linstow's description is based on a single immature female. This measured 15.8 mm. in length and 0.55 mm. in thickness. The cuticle was finely striated. There were said to be no dentigerous ridges or interlabia. The dorsal lip was 0.088 mm. long and 0.132 mm. wide and of quadrangular shape, with the anterior angles rounded. The pulp was produced into two quadrangular lobes in front. The œsophagus occupied a quarter of the total length, and the intestine gave off a ventral cæcum two-thirds as long as the œsophagus. The tail was short and conical, measuring 1/57 of the total length.

4. Genus **CONTRACÆCUM** Railliet and Henry, 1912.

Synonyms :—*Kathleena* Leiper and Atkinson, 1914 ; *Cerascaris* Cobb, 1929.

Lips without dentigerous ridges. Interlabia present, usually very well developed. Œsophagus with a small ventriculus, giving off a solid posterior appendix. An intestinal cæcum present. Adult worms in intestine or stomach of fish-eating mammals and birds, and of fishes.

Genotype :—*Contracæcum spiculigerum* (Rud., 1809).

Key to Species.

Parasite of Ganges dolphin	<i>lobulatum</i> , p. 87.
Parasites of birds	1.
Parasites of fishes	4.
1. Parasite of cormorants	<i>spiculigerum</i> , p. 79.
Parasite of birds of prey	<i>haliaëti</i> , p. 83.
Parasites of herons, egrets, storks, &c.	2.
2. Interlabia without transverse processes.	3.
Interlabia with transverse processes. . . .	<i>tricuspe</i> , p. 84.
3. Male with six pairs of postanal papillæ.	
Spicules 2.3–2.8 mm. long	<i>microcephalum</i> , p. 81.
Male with nine pairs of postanal papillæ.	
Spicules 3.28 mm.	<i>rosarium</i> , p. 82.
Male with ten pairs of postanal papillæ.	
Spicules 1.8 mm.	<i>engonium</i> , p. 85.
4. Adult parasitic in sword-fish and peacock-fish	<i>incurvum</i> , p. 88.
Adult parasitic in shark and skate.	<i>plagiostomorum</i> , p. 90.
Adult parasitic in <i>Trichiurus</i>	<i>trichiuri</i> , p. 91.

1. **Contracæcum spiculigerum** (Rud., 1809) Railliet and Henry, 1912. (Fig. 32.)

Synonyms :—*Ascaris spiculigera* Rudolphi, 1809 ; *Ascaris variegata* Rudolphi, 1809.

Hosts :—This extremely widely distributed form occurs in almost all species of cormorants in all parts of the world.

It has also been recorded from a variety of other fish-eating birds, including pelicans, gulls, divers, guillemots and mergansers. In India it has been recorded from the little cormorant (*Phalacrocorax niger* [*P. javanicus*], at Samal Island, Lake Chilka, Orissa, and the Indian shag (*Phalacrocorax fuscicollis*) (Baylis and Daubney). v. Linstow also records it (though this record may possibly refer to *C. tricuspe* or another species) from the Indian darter or snake-bird (*Anhinga* [*Plotus*] *melanogaster*) at Wirawila, Southern Province, Ceylon.

The external appearance of this species appears to be very variable, some specimens being relatively long and slender, others short and stout. It is possible that there may be a number of geographical races or host-races, but the differences between them do not appear to be of sufficient importance to be regarded as specific.

The average length of the male is about 30–45 mm., and that of the female rather greater. The male attains a

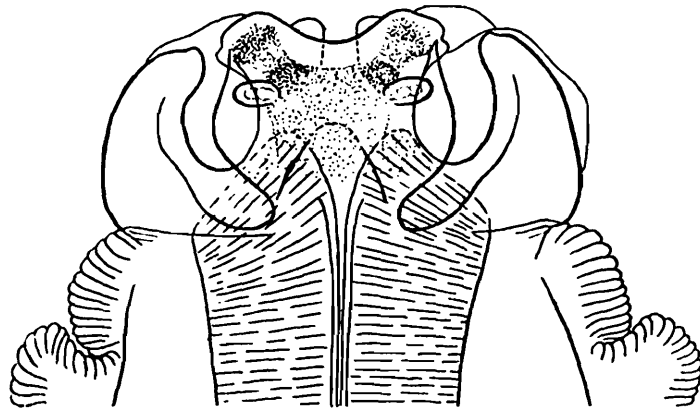

Fig. 32.—*Contracæcum spiculigerum*. Head of female; dorsal view. (Original.)

maximum thickness of about 0.9 mm., the female of 1.8 mm. The head is relatively small, and is followed by a wider neck, the cuticle of which is thrown into deep transverse folds, giving it a serrated appearance. The cuticular striations on the body are about 62–92 μ apart. The lips are rather small, and each is produced anteriorly to form two forwardly and laterally directed processes. The interlabia are large (almost as long as the lips) and falciform, with their tips bent inwards. The œsophagus is narrow and occupies about 1/9 or 1/8 of the total length. The œsophageal appendix measures 1.2–1.86 mm. in length, and the intestinal cæcum, which is very voluminous, runs forward for a very considerable portion of the length of the œsophagus.

The tail of the male is conically pointed and measures 0.25 mm. or more in length. There are seven pairs of post-anal papillæ (four subventral, three lateral) and 38 to 56 pairs of preanal papillæ. The spicules are of relatively great

length, measuring in some specimens as much as 8 mm., and have well-developed alæ.

The tail of the female is conical and about 0.4 mm. long. The vulva is situated at about the anterior third of the body. The eggs are spherical and measure 0.05–0.052 mm. in diameter.

2. *Contracæcum microcephalum* (Rud., 1809) Baylis, 1920.
(Fig. 33.)

Synonyms:—*Ascaris microcephala* Rudolphi, 1809; *Kathleena arcuata* Gedoelst, 1916; *Contracæcum quadricuspe* Walton, 1923; ? *Ascaris coronata* v. Linstow, 1906.

Hosts:—This species has been recorded from a number of species of herons, egrets, bitterns and storks in Europe, Asia, Africa and North America, and even in the domestic duck. The determination of the species may, in some cases, be open to question. In India it has been recorded from the pond heron (*Ardeola grayii*) at Samal Island, Lake Chilka, Orissa (Baylis and Daubney), while v. Linstow's record of *Ascaris coronata* from the same host at Tissamaharama, Ceylon, very probably refers to *C. microcephalum*.

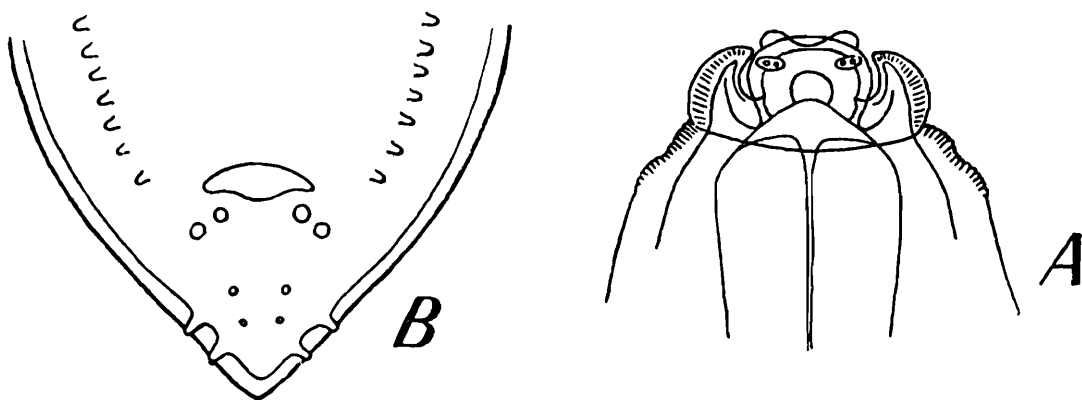

Fig. 33.—*Contracæcum microcephalum*. A, head, dorsal view; B, posterior end of male, ventral view. (After Gedoelst.)

The male is 15–45 mm. long, the female 23–70 mm. The maximum thickness is 0.9–1 mm. in the male and about 1.1 mm. in the female. The lips are relatively small and have paired anterior processes. On the inner surface of each lip there is a longitudinal groove. The interlabia are large (nearly as long as the lips), and have slight indentations at their tips. The cuticle of the neck is deeply folded, as in *C. spiculigerum*. There is a pair of cervical papillæ at 0.4–0.72 mm. from the anterior end. The œsophagus is 2.8–3.6 mm. long, the œsophageal appendix 0.8–1.25 mm., and the intestinal cæcum about three-quarters of the length of the œsophagus.

The tail of the male is 0.23–0.24 mm. long. There are six pairs of postanal papillæ (four subventral, two lateral) and 20 to 31 pairs of preanal papillæ. The spicules, which have well-developed alæ, measure 2.3–2.8 mm. in length.

The tail of the female is 0.44–0.5 mm. long and is conical. It bears a pair of papillæ at 0.24 mm. from the tip. The vulva is in front of the middle of the body, which it divides in the proportion of 2 : 3 or 1 : 4. The eggs are subglobular or oval and measure 0.064–0.072 × 0.048–0.064 mm. Their shells are thin and have a rough surface.

3. *Contracæcum rosarium* (Connal, 1912) Baylis, 1920.
(Fig. 34.)

Synonym :—*Ascaris rosarius* Connal, 1912.

Hosts :—Originally recorded from a night heron (*Nycticorax* sp.) in West Africa, this species has been recorded from *Nycticorax nycticorax* [*N. griseus*] in India by Baylis and Daubney.

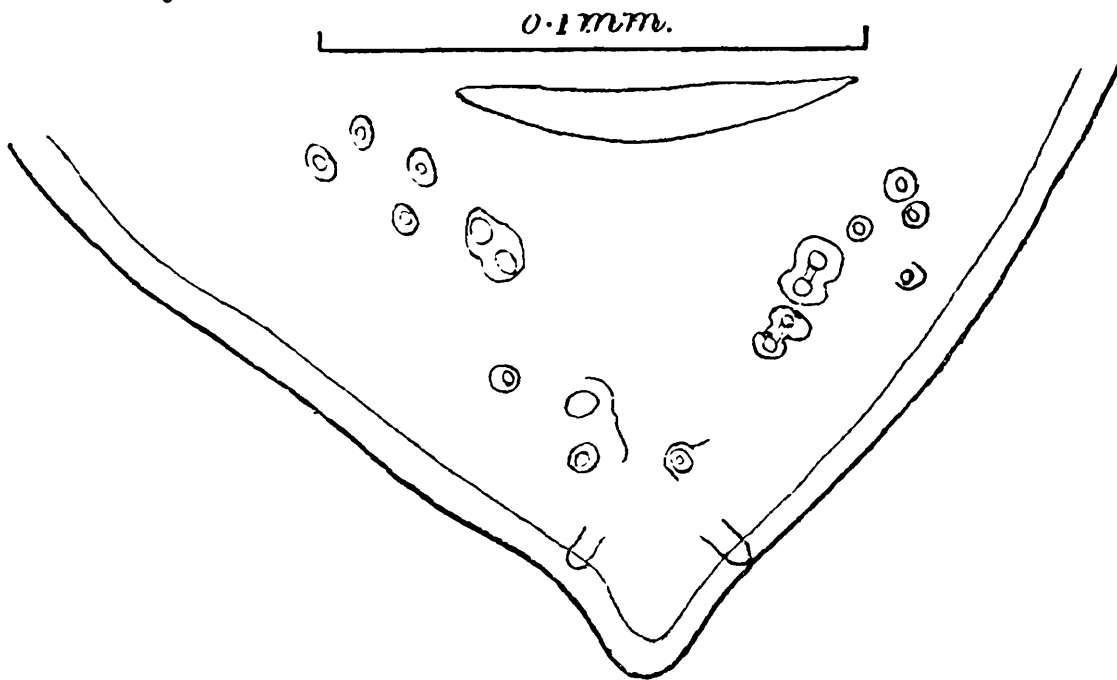

Fig. 34.—*Contracæcum rosarium*. Posterior end of male ; ventral view.
(After Baylis and Daubney.)

This form is very similar to *C. microcephalum*, but differs from it in the number of caudal papillæ in the male. The male measures about 26 mm. in length and 0.6 mm. in maximum thickness, the female 30.8 and 0.7 mm. respectively. The width of the head (in the male) is about 0.2 mm. The neck widens abruptly to 0.3 mm. The œsophagus is 3.9 mm. long (in the male), its appendix 0.7 mm. and the intestinal cæcum 2.46 mm. The nerve-ring is situated at 0.5–0.57 mm., and the excretory pore at 0.51–0.59 mm., from the anterior end.

The tail of the male is 0.22 mm. long, according to Connal. In the Indian material referred to above it measured only about 0.1 mm. According to Connal's description there are only three pairs of postanal papillæ. Baylis and Daubney found nine pairs, the fifth from the posterior end being double papillæ. The preanal papillæ are numerous. The spicules are alate and measure 3.28 mm. in length.

The vulva of the female is situated at 1.59 mm. from the anterior end, according to Connal, and the vagina is about 0.17 mm. long. The eggs, according to the same author, are rounded ovoid, measure 0.026×0.021 mm., and have thick shells.

4. *Contracæcum haliaëti* Baylis and Daubney, 1923.

Synonyms :—*Ascaris aquillæ* Smith, Fox and White, 1908, nec *Ascaris aquilæ* Gmelin, 1790 ; ? *Ascaris ceylanica* v. Linstow, 1904 ; ? *Ascaris ceylonica* v. Linstow, 1907 ; ? *Ascaris zeylanica* v. Linstow, 1907 ; ? *Ascaris fissicollis* v. Linstow, 1906.

Hosts :—*Ascaris aquillæ* Smith, Fox and White, which was renamed *C. haliaëti* by Baylis and Daubney, was originally recorded from a sea-eagle (*Haliaeetus leucocephalus*) in the Zoological Gardens at Philadelphia, U.S.A. Baylis and Daubney recorded what was believed to be the same species from the white-bellied sea-eagle (*Haliaeetus leucogaster*) at Barkuda Island, Lake Chilka, Orissa. The species described by v. Linstow under the name of *Ascaris ceylanica* (of which *ceylonica* and *zeylanica* are simply variants) was recorded from the fish-eagle (*Ichthyophaga [Poliaëtus] ichthy-aëtus*) at Kalpitiya, and from the Brahminy kite (*Haliastur indus*) at Colombo, in Ceylon. The species described by the same author as *Ascaris fissicollis* was also recorded from *Haliastur indus* at Nedunkeni, Northern Province, Ceylon. All these supposed species are imperfectly described, and, with the exception of *A. ceylanica*, known from females only, but there seems to be some justification for thinking that they are all one species. Pending a definite solution of this question, however, the name *haliaëti* is retained.

The material described by Smith, Fox and White consisted of two females only, one of which was damaged. The complete specimen measured 50 mm. in length and 1.5 mm. in thickness. The head was 0.25 mm. wide at the base. The dorsal lip measured 0.11 mm. in length and 0.15 mm. in width at the base, and had two large anterior projections. The œsophagus had a posterior appendix, and a large intestinal cæcum was present. The vulva was in front of the middle of the body. The eggs, which had thin shells, covered with small tubercles, measured $0.08-0.09 \times 0.05-0.06$ mm.

In his description of *Ascaris ceylanica* v. Linstow states that all the specimens were fragmentary. He mentions that there were no dentigerous ridges and that large interlabia were present, so that, although no mention is made of the structure of the alimentary canal, it seems probable that he was dealing with a species of *Contracæcum*. The male had a thickness of 1.22 mm., the female of 1.5 mm. The dorsal lip was 0.073 mm. long and 0.099 mm. wide. The tail of the male was 0.22 mm. long, and the spicules measured 5.53 mm. in length. The tail of the female was 0.32 mm. long, and the eggs are described as thick-shelled and spherical, with a diameter of 0.062 mm.

In describing *Ascaris fissicollis* v. Linstow again mentions that dentigerous ridges are absent and interlabia present. The latter are "obtusely conical, attenuate from the middle, with an outer groove." The material included three females, measuring 15, 34 and 36 mm. respectively in length and 0.79–1.25 mm. in thickness. The cuticle is annulate. "Behind the lips the annulation is so deep that the contours appear fringed." The dorsal lip is semicircular in outline, and measures 0.083 mm. long and 0.11 mm. wide. The œsophagus occupies 1/6 of the total length. The tail measures 1/49 of the total length. The eggs are thin-shelled and spherical, with a diameter of 0.065 mm.

Through the kindness of the Director of the Colombo Museum the writer has been able to examine the type-specimens of *A. fissicollis*. These are in rather poor condition, and the head of what was probably the 34 mm. specimen is missing. The smallest specimen is not quite mature. v. Linstow makes no mention of the presence of an intestinal cæcum or an œsophageal appendix. Both these structures are present, and the species is a typical *Contracæcum*. In the 36 mm. specimen the œsophagus is about 5 mm. long. The œsophageal appendix is short (0.6 mm.), and the intestinal cæcum extends forward to a point about 1.6 mm. from the anterior end. The vulva is situated a little in front of the middle of the body.

5. *Contracæcum tricuspe* (Gedoelst, 1916) Baylis, 1920.
(Fig. 35.)

Synonym :—*Kathleena tricuspis* Gedoelst, 1916.

Hosts :—Originally recorded from a heron (*Ardea* sp.) in the Belgian Congo. Recorded by Baylis and Daubney from the Indian darter or snake-bird (*Anhinga* [*Plotus*] *melanogaster*) at Calcutta.

The male is 13.8 mm. long, the female 12.1–17.5 mm. The maximum thickness is 0.785 mm. in the male, 0.96–1.28 mm.

in the female. The cuticle of the neck is deeply folded transversely. The lips are notched laterally, and each of the interlabia has two transverse processes which fit into the notches of the lips. The œsophagus is 3·8–3·9 mm. long and the œsophageal appendix 1·6–2 mm. The intestinal cæcum extends forward as far as the anterior quarter of the œsophagus. The cervical papillæ are situated at about 0·7 mm. from the anterior end.

The tail of the male is 0·14 mm. long, and has a terminal appendage. There are six pairs of postanal, one pair of adanal

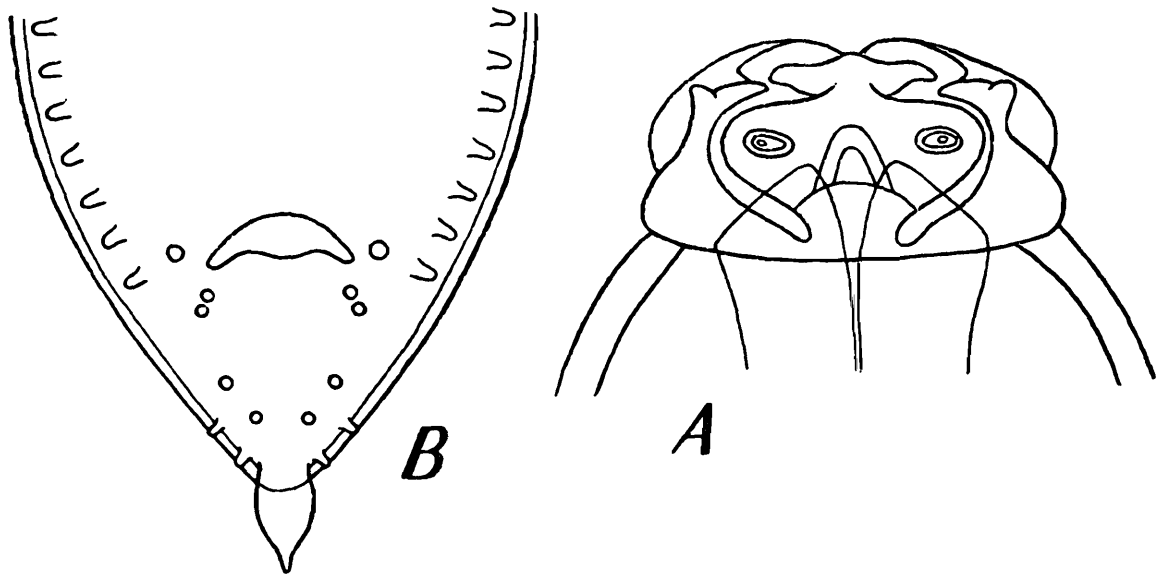

Fig. 35.—*Contracæcum tricuspe*. A, head, dorsal view; B, posterior end of male, ventral view. (After Gedoelst.)

and about fifty pairs of preanal papillæ, arranged in regular series. The spicules measure 4·6 mm. in length.

The tail of the female is conical and 0·35–0·44 mm. long, and has a pair of papillæ at 0·18 mm. from the tip. The vulva is situated at about $\frac{2}{5}$ of the total length from the anterior end. The type-specimens contained no mature eggs.

6. *Contracæcum engonium* Baylis and Daubney, 1922. (Figs. 36 & 37.)

Host :—Black stork (*Ciconia nigra*); Zoological Gardens, Calcutta.

The description of this species was based on a single male specimen. This measured 13 mm. in length and 0·57 mm. in maximum thickness. The original description is as follows :—

The head measures 0·19 mm. in diameter, and is constricted off from the body. The interlabia are simple and undivided at the tip. The dorsal lip is rounded anteriorly and carries

a pair of double papillæ. The pulp roughly follows the shape of the lip, but is indented on its anterior edge. Each lip is provided with a pair of flattened processes springing from the internal surface and projecting anteriorly like two small horns at the shoulders of the lip. The muscular portion of the œsophagus measures 2·75 mm. in length and 0·14 mm. in thickness. The intestinal cæcum is broad and reaches

Fig. 36.

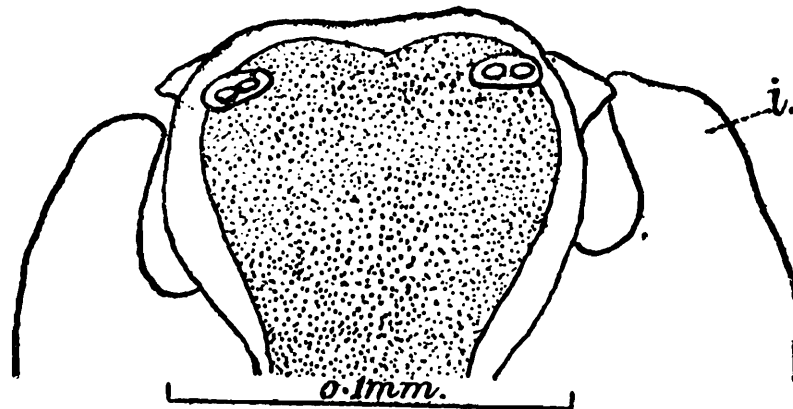

Fig. 37.

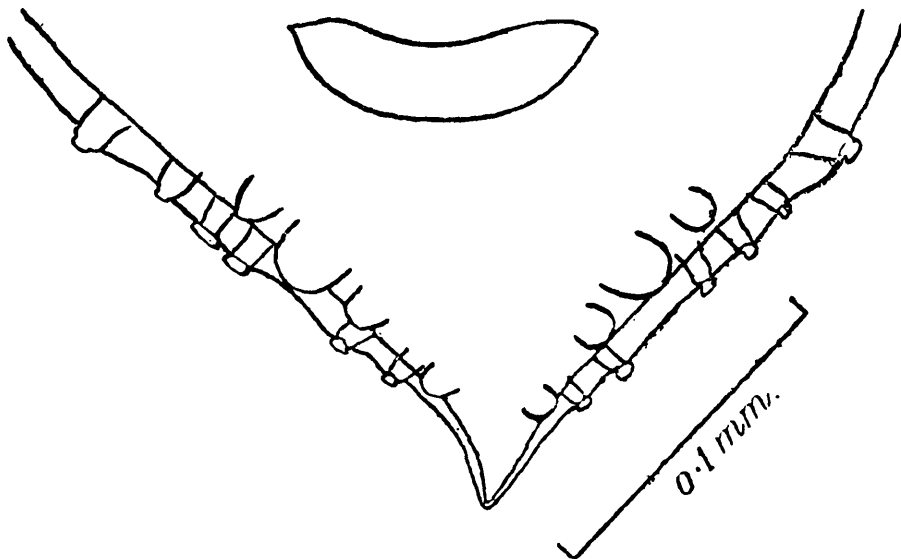

Fig. 36.—*Contracæcum engonium*. Head; dorsal view. *i.*, interlabium. (After Baylis and Daubney.)

Fig. 37.—*Contracæcum engonium*. Posterior end of male; ventral view. (After Baylis and Daubney.)

to within 0·69 mm. of the head-end. There is a short ventriculus, measuring about 0·14 mm. in length and about as broad as long. From this is given off a posterior appendix which is 0·7 mm. in length and 0·15 mm. in thickness.

The spicules are equal, long and slender, measuring 1·8 mm. in length and 0·022 mm. in breadth. They consist of a cylindrical shaft with narrow lateral alæ. The cloaca is situated at 0·125 mm. from the tip of the tail, which is abruptly

attenuated to a conical point. There are ten pairs of postanal papillæ, of which the first, fourth, fifth and seventh are latero-ventral. The remaining six pairs are lateral and pedunculate, and fall into two groups: a group of two pairs (the second and third) close to the tip, and a group of four pairs extending from about the middle of the tail almost to the cloaca.

7. *Contracæcum lobulatum* (Schneider, 1866) Baylis and Daubney, 1923. (Fig. 38.)

Synonyms:—*Ascaris lobulata* Schneider, 1866; ? *Ascaris delphini* Rudolphi, 1819.

Host:—The Ganges dolphin (*Platanista gangetica*) (recorded from the mouth, stomach, small and large intestines); Ganges and Hooghly Rivers.

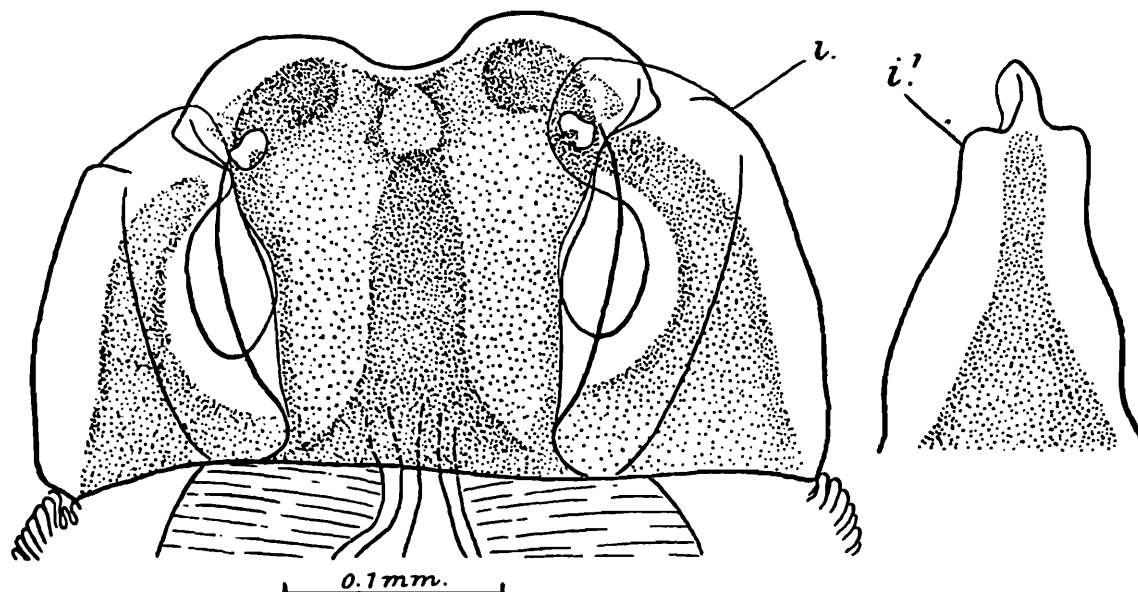

Fig. 38.—*Contracæcum lobulatum*. Head of female; dorsal view. *i.*, *i'*., interlabium. (After Baylis and Daubney.)

The length of both sexes is about 30–40 mm., and the maximum thickness about 1.1 mm. The lips are rather longer than broad, and have paired, outwardly-directed anterior lobes which form acute angles. The dorsal lip is about 0.2 mm. long and 0.17 mm. wide. Its pulp has two main lobes which extend into the anterior lobes of the lip itself and are separated by a deep “saddle” on the inner side. Each of the main lobes also gives origin to a rounded accessory lobe which projects inwards and downwards when the lip is viewed from the dorsal surface. The interlabia are nearly as long as the lips. Each has its free end compressed into a narrow cuticular flange and curved inwards between two of the lips. A well-marked “shoulder” is formed at the point where the compression occurs. The

cuticle of the neck is thrown into deep transverse folds. The œsophagus is about $1/15$ of the total length. There is a very short œsophageal appendix and a very long and wide intestinal cæcum.

The tail of the male is about 0.2 mm. long. There are 12 pairs of postanal papillæ, which are very irregularly arranged, roughly in two rows on each side, and about seven pairs of preanal papillæ, arranged in a single regular row on each side. The spicules measure 2.37 mm. in length.

The tail of the female is about 0.5 mm. long. The vulva is situated at about the anterior quarter of the body. The eggs measure 0.052×0.042 mm.

8. *Contracæcum incurvum* (Rud., 1819) Baylis and Daubney, 1922. (Figs. 39 & 40.)

Synonym :—*Ascaris incurva* Rudolphi, 1819.

Hosts :—The type host of this species is the sword-fish (*Xiphias gladius*), from which it has been recorded in various

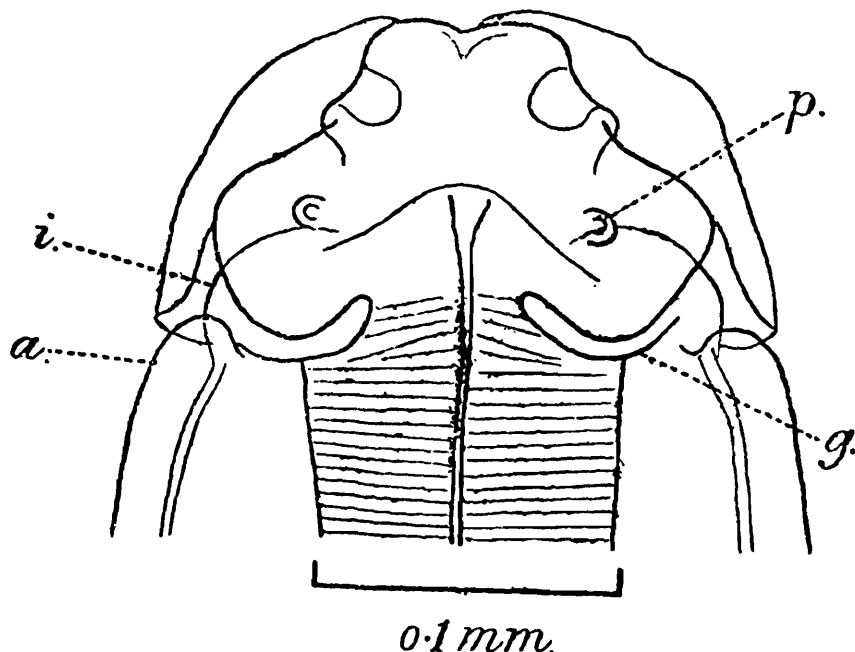

Fig. 39.—*Contracæcum incurvum*. Head of male; dorsal view. *a.*, cervical ala; *g.*, interlabial groove; *i.*, interlabium; *p.*, papilla. (After Baylis and Daubney.)

parts of the world. Linton has also recorded adult or immature forms, considered by him to belong to this species, from several other fishes in American waters (*Scomberomorus maculatus*, *Tetrapterus imperator*, *Seriola zonata*, *S. lalandi*, *Hippoglossus platessoides*). In Indian waters adult but probably not quite full-grown specimens have been recorded by Baylis and Daubney from the stomach of the peacock-fish (*Histiophorus gladius*).

The size of this species appears to be very variable, measurements given by different authors varying between 34.3 and 90 mm. for the male and between 22 and 122 mm. (or even 267 mm., according to Linton) for the female. The thickness of the male is given as 0.55–0.75 mm., and that of the female as 0.75–3 mm. The body is somewhat tapering anteriorly. The cuticular striations are coarse (8–12.5 μ) and prominent, giving the outlines of the body a serrated appearance in optical section. The diameter of the head is about 0.2–0.4 mm. The lips have sinuous margins anteriorly and laterally, and their hinder portions are produced into broad cuticular flanges. The ventro-lateral lips are

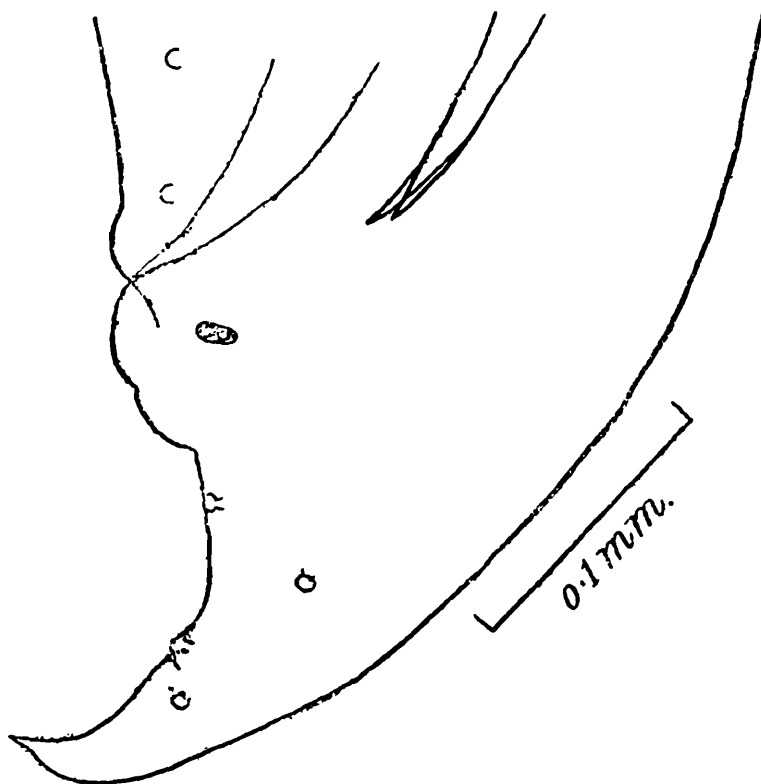

Fig. 40.—*Contracæcum incurvum*. Posterior end of male; lateral view (After Baylis and Daubney.)

asymmetrical in shape, their ventral angles being considerably produced. The interlabia are rather short and compressed between the lips. Well-marked interlabial grooves run from them round the bases of the lips. There is a pair of cervical alæ, originating just dorsally to the lateral interlabia and extending back to a point about 2 mm. from the anterior end. They are about 0.05 mm. wide at the widest part. The conspicuous cervical papillæ are situated dorsally to the alæ, at 0.65 mm. from the anterior end in a specimen 34.3 mm. long. In the same specimen the nerve-ring is at 0.55 mm. and the excretory pore at 0.68 mm. from the anterior end, while the œsophagus measures about 3 mm. in length,

including the ventriculus. (According to Dujardin, the œsophagus attains a length of 7.2 mm.) The ventriculus measures 0.16 mm. in diameter. The œsophageal appendix is relatively long (about 3 mm.). The length of the intestinal cæcum varies between 2 mm. and 6.2 mm.

The posterior end of the male is usually coiled into one or two turns of a spiral. Its ventral surface, from about 0.7 mm. in front of the cloaca forward for about 2 mm., has the cuticle raised into pronounced longitudinal ridges, interrupted by transverse grooves at intervals of 0.03 mm. The tail is about 0.2 mm. long, sharply tapering, curved ventrally and drawn out at the tip into a slender spike. The caudal papillæ are all rather small. There are four pairs of postanal papillæ (two ventral and two lateral), one pair of double adanal papillæ and about 15 pairs of preanal papillæ, small and close together near the cloaca, but becoming larger and more widely spaced anteriorly. The spicules measure 4.1–4.4 mm. in length and about 0.05 mm. in width. They have broad alæ except for a short portion at the tip.

The tail of the female is straight and pointed, and measures 0.36–1.7 mm. in length, according to different accounts. There is a sudden constriction behind the anus. The vulva is situated at about the anterior third of the body. According to Dujardin the vagina is 3–5 mm. long, widening into an unpaired portion of the uterus, 20 mm. long and 1.7–2.4 mm. wide (in a specimen 122 mm. long). This gives off the two parallel uterine branches, which are 46 mm. long and 1.7 mm. wide. Each branch doubles forward at 57 mm. from the vulva. The ovarian tubes run straight forward to near the level of the vulva, form some folds there, and then run straight back again towards the posterior end of the body, where they form a mass of coils behind the uterine branches. The eggs are globular and measure 0.07×0.05 mm. Their shells are thin and membranous and are covered with minute depressions.

9. *Contracæcum plagiostomorum* (v. Linst., 1905). (Fig. 41.)

Synonym :—*Ascaris plagiostomorum* v. Linstow, 1905.

Hosts :—Stomach of *Cetorhinus* [*Selache*] *maximus* (the basking shark), Ceylon ; gills of *Raja radiata*.

According to v. Linstow's description the male of this species is 17 mm. long and 0.75 mm. in thickness, the female 28 mm. and 1.58 mm. respectively. The cuticle is transversely striated. The lips are very short and broad, and have their papillæ placed anteriorly. On the inner side of each lip is a rounded projection, at the apex of which there are two "teeth," abruptly truncate in front and bearing denticles.

Dentigerous ridges and interlabia are said to be absent. The œsophagus is about $1/12$ of the total length, and has a posterior appendix, longer than the œsophagus itself, lying ventrally to the intestine. The latter has an anterior cæcum measuring $5/12$ of the length of the œsophagus. There is a pair of rounded cervical papillæ close in front of the middle of the œsophagus.

The tail of the male is $1/86$ of the total length, and has a finger-shaped terminal appendage. There are six pairs of postanal papillæ, three of which are subventral (two close

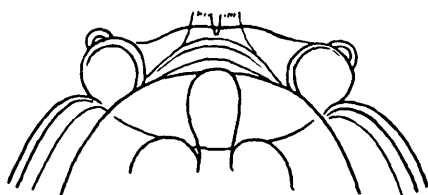

Fig. 41.—*Contracæcum plagiostomorum*. Head.
(After v. Linstow.)

to the cloaca, one near the tip of the tail) and three lateral, of which the anterior is the largest. The preanal papillæ number about 70 on each side, in a single row, gradually becoming smaller and closer together posteriorly.

The tail of the female is blunt and measures $1/175$ of the total length. The vulva is in the middle of the body. The eggs are spherical and measure 0.039 mm. in diameter.

10. *Contracæcum trichiuri* Thwaite, 1927.

Host :—*Trichiurus savala*, Ceylon.

The description of this species is based on two males only, the female being unknown. The lengths of the two specimens were 33.7 and 34.4 mm., and the maximum thickness about 1.1 mm. The body tapers towards the anterior end. The head is about 0.22 mm. wide, the dorsal lip measuring about 0.16 mm. wide and 0.14 mm. long. The interlabia are 0.06 mm. long, and the greater part of them appears to be hidden by the lips. The body has a pair of well-developed lateral alæ which originate immediately behind the lips, are transversely striated and have a maximum width of 0.07 mm. The œsophagus is about 3 mm. long, and has a ventriculus measuring about 0.16 mm. in diameter. The œsophageal appendix measures about 0.95 mm. in length and the intestinal cæcum only 0.36 mm. The cervical papillæ are situated at 0.63 mm., and the excretory pore at about 0.76 mm., from the anterior end. The nerve-ring is just in front of the cervical papillæ.

The tail is conical and measures 0.14–0.205 mm. in length. Its tip is covered with minute cuticular spines. There are numerous inconspicuous postanal papillæ on the ventral surface; Thwaite was unable to determine their number.

The preanal papillæ number about 24 pairs, and become larger and more widely spaced anteriorly. The spicules are subequal, slender and alate. They measured in one specimen 0·82 and 0·835 mm., and in the other 0·875 and 0·925 mm. in length.

11. *Contracæcum balistis* (v. Linst., 1905).

Synonym :—*Ascaris balistis* v. Linstow, 1905.

Hosts :—*Balistes mitis*, *B. stellaris*, Ceylon. Position in host not mentioned by v. Linstow.

This is a larval form measuring 10 mm. in length and 0·22 mm. in thickness. The cuticle is said to be smooth. There are three indistinct lips. The œsophagus is $1/12\cdot5$ of the total length, and has a posterior appendix, as long as itself, lying ventrally to the intestine. There is also a dorsal intestinal cæcum one-third as long as the œsophagus. The tail is slightly knobbed at its tip and measures $1/51$ of the total length.

Larval forms of Contracæcum.

Baylis and Daubney (1923) record larvæ of one or more species of this genus from the peritoneum of the following fishes :—

Barilius bola. Localities : Tharai River ; Gandak River, Saran, N. Bengal.

Callichrous pabda. Locality : Lucknow.

Wallago attu. Locality : Lucknow.

The material from *Callichrous* and *Wallago* was part of that referred to by Stewart (1914, p. 179) under the numbers L. 33 and L. 36.

5. Genus **PARANISAKIS** Baylis, 1923.

Lips with dentigerous ridges. Interlabia present. Œsophagus with a ventriculus, but no œsophageal appendix or intestinal cæcum. Adult worms in the intestine of fishes.

Genotype :—*Paranisakis squatinæ* Baylis, 1923.

1. *Paranisakis pastinacæ* (Rud., 1819). (Fig. 42.)

Synonyms :—*Ascaris pastinacæ* Rudolphi, 1819 ; *Ascaris quadrata* v. Linstow, 1905 (*nec* 1904) ; *Paranisakis tæniuræ* Thwaite, 1927.

Hosts :—*Trygon pastinaca* (recorded by Rudolphi) ; *Tæniura* sp. (v. Linstow) ; *Tæniura melanospilos*, Ceylon (Thwaite).

There is, in the writer's opinion, little doubt that the forms recorded by Rudolphi, v. Linstow and Thwaite are all

identical. Rudolphi did not describe the worm, but his type-specimens were re-examined by v. Drasche (1883), who gives figures of the dorsal lip, which is very similar to that of the genotype, *P. squatinæ*.

According to v. Linstow's description of *Ascaris quadrata*, the male is 43 mm. long and 0.87 mm. thick, the female 58 mm. and 1.38 mm. respectively. The lips are described as quadrilateral, with a narrower base. The presence of dentigerous ridges and interlabia is mentioned. The œsophagus occupies 1/18 of the total length, and ends in a small "bulb."

The tail of the male is 1/215 of the total length, and, according to the figure, is bluntly rounded, but possesses a terminal spike. There are, on each side, five postanal, one adanal and eight preanal papillæ. The spicules measure 0.53 mm. in length.

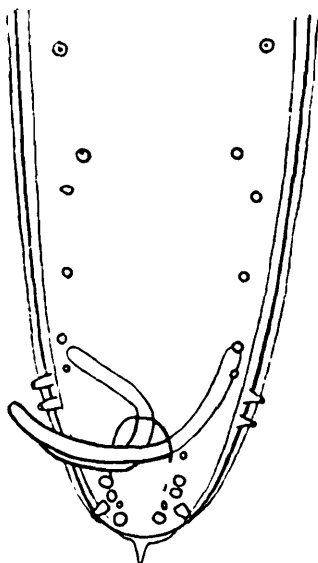

Fig. 42.—*Paranisakis pastinacæ*. Posterior end of male; ventral view. (After v. Linstow.)

The tail of the female is 1/123 of the total length and is tapering, with a rounded tip. The vulva is said to be in the middle of the body. The vagina is 3.8 mm. long, relatively stout (0.14 mm.) in the quarter nearest to the vulva, and more slender (0.06 mm.) for the remainder of its length. The uterine branches are 0.1 mm. wide at their origin. The eggs are globular, measuring 0.068 mm. in diameter, and have thin, membranous shells covered with fine granulations.

Thwaite gives a somewhat fuller description of the female, but his material included no males. The four females examined by him measured 46–61 mm. in length and 0.83–1.2 mm. in maximum thickness. The cuticular striations were at intervals of 10–12 μ . Narrow lateral alæ, according to Thwaite, are present, beginning at about 0.15–0.33 mm. from the anterior end and running posteriorly along the

body. The cervical papillæ are situated at 0.73–0.86 mm. from the anterior end, and the nerve-ring just in front of them. The head measures 0.115–0.16 mm. in length and 0.22–0.28 mm. in width. The neck is wider than the head. The anterior portions of the lips, with the characteristic inwardly-curved anterior lobes of the pulp, appear to have been turned inwards in Thwaite's material, so that they escaped observation. The dentigerous ridges also were not seen. The interlabia are described as rectangular in outline, measuring 0.045–0.07 mm. in length and having a triangular pulp. The œsophagus measures 3–3.8 mm. in length, including the ventriculus, which has a diameter of about 0.33 mm. and is almost spherical.

The conical tail measures 0.63–0.73 mm. in length. The vulva is inconspicuous, and is said to be situated almost exactly at the anterior third of the body. The eggs measure about 0.07×0.04 mm., and their shells are covered with finely corrugated markings.

2. "*Ascaris*" *meleagrinae* v. Linstow, in Shipley and Hornell, 1904. (Not *Ascaris meleagrina* "Kollar," in Örley, 1882 (*nomen nudum*).)

Hosts :—The larval form to which this name is applied is stated to occur in cysts in the tissues (usually the gonad, less frequently the tissues of the mantle) of the pearl-oyster (*Margaritifera vulgaris*) in the Gulf of Manaar. According to Shipley and Hornell (1904) the adult form occurs in the intestine of file-fishes (*Balistes mitis*, *B. stellaris*) in the same locality, while *Platax teira* is also said to be a host of the adult by the same authors (1906).

The adult worm has not been described, and the systematic position of the species is very doubtful. The very brief description of the larva given by v. Linstow suggests that it may possibly belong to the genus *Paranisakis*, but it might also be a *Porrocœcum*. According to v. Linstow the greatest length is 29 mm. and the width 0.55 mm. The dorsal lip has two large papillæ directed forward (in the figure these appear to be double). Dentigerous ridges and interlabia are present, the latter, according to the figure, being well developed and rather more than half as long as the lips. The œsophagus is said to occupy $1/813$ of the total length, a figure in which an error must be suspected. No mention is made of the presence of ventriculus or cæca. The tail is $1/116$ of the total length. "A pair of anal glands occurs in the end of the alimentary canal."

3. "*Ascaris*" *balisticola* v. Linstow, 1905.

Hosts :—This is a larval form, recorded from the file-fishes, *Balistes mitis* and *B. stellaris*, off Ceylon. Its position in the hosts is not given. The species is mentioned here because of its possible connection with "*A.*" *meleagrinxæ*. There is even less indication in this case of the genus to which the species should be assigned, though it is stated by v. Linstow that the œsophagus and intestine are without cæca.

According to v. Linstow's description the worm is 7.4 mm. long and 0.22 mm. thick. There is a "boring-tooth" at the anterior end, so that it is evidently a quite immature form. The œsophagus occupies 1/9 of the total length. The tail is very short (1/169 of the total length) and conical, with a rounded tip.

6. Genus **DUJARDINIA** Gedoelst, 1916.

Lips, at least in the adults, without dentigerous ridges, but with the cuticle of their inner surfaces produced into large tooth-like structures, apparently capable of being interlocked. These structures are carried by three main cuticular lobes on the anterior border of each lip. Interlabia present. Well-marked interlabial grooves run from them to the bases of the lips. Œsophagus with a small subglobular bulb. No œsophageal appendix. An intestinal cæcum present. Excretory pore at level of nerve-ring. Caudal end of male with rather well-developed lateral alæ extending for a short distance in the region of the cloaca. Caudal papillæ few. Spicules equal and slender. An accessory piece usually present, of characteristic shape, with an expanded and solid head at the proximal end, and hollow and tapering distally. The lumen of the distal portion has an opening on the posterior surface of the organ. Female with vulva in anterior half of body, opening, in the genotype, into a muscular, almost sucker-like "atrium," from which the very long and slender vagina runs posteriorly. This ends in a small, expanded egg-chamber, from which are given off posteriorly the two uterine branches, narrow and coiled at first, voluminous and thin-walled more posteriorly. Eggs with very thin, membranous shells, roundish-oval or subglobular. Adult worms in the alimentary canal of aquatic vertebrates (crocodiles, fishes, dugong).

Genotype :—*Dujardinia helicina* (Molin, 1860).

Key to Species.

Parasite of dugong	<i>halicoris</i> , p. 99.
Parasites of crocodiles	1.
1. Spicules of male about 8 mm. Accessory piece with trifold tip	<i>helicina</i> , p. 96.
Spicules of male 1.25 mm. Accessory piece with simple tip	<i>woodlandi</i> , p. 97.

1. ***Dujardinia helicina*** (Molin, 1860) Gedoelst, 1916. (Fig. 43.)

Synonym :—*Ascaris helicina* Molin, 1860. (Not *Trispiculascaris helicina* (Molin) of Skrjabin, 1916.)

Hosts :—This species has been recorded in Africa from *Crocodilus niloticus* and *C. cataphractus*, in America from *C. americanus*, and in India from *Crocodilus porosus* (Port Canning, Ganges Delta ; Baylis and Daubney).

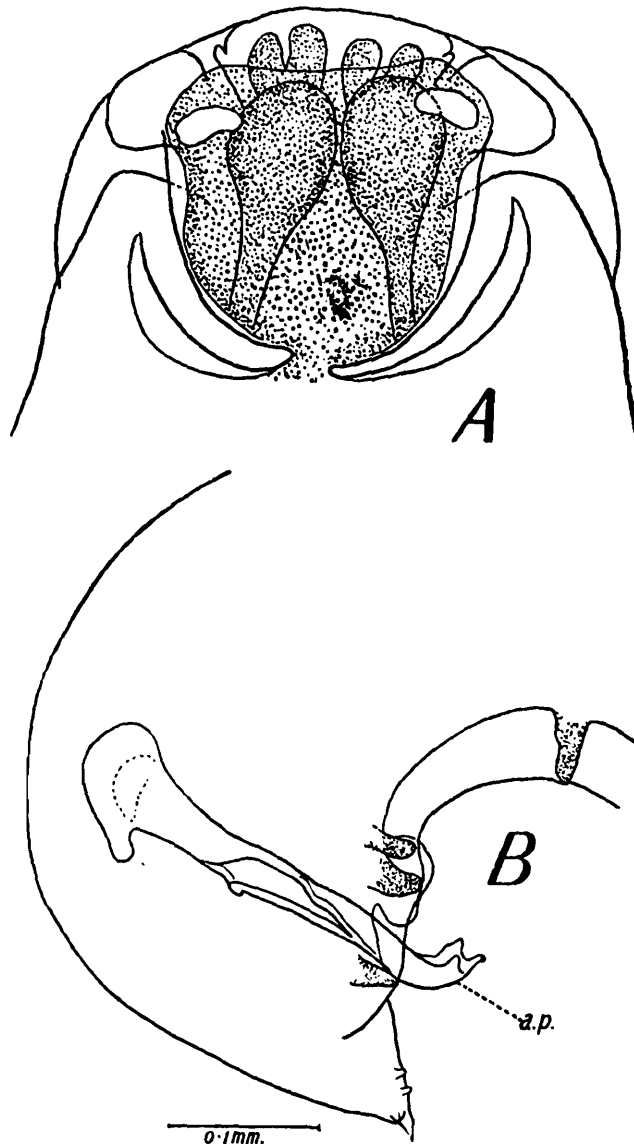

Fig. 43.—*Dujardinia helicina*.—A, head, dorsal view ; B, posterior end of male, lateral view. *a.p.*, accessory piece. (After Baylis, in 'Parasitology.')

The length of the male is about 18 mm. and its maximum thickness 0.6 mm. The female measures 35–40 mm. and about 2.2 mm. respectively. The posterior part of the body, especially in the female, is helicoidally twisted, invariably with a right-handed spiral. The diameter of the head is 0.15–0.3 mm. The dorsal lip has two bifurcated anterior pulp-processes projecting into the middle lobe. These processes are carried at the swollen ends of two club-shaped masses of pulp. The œsophagus, including the bulb, is about 3.4 mm. long in the male, 4.4 mm. in the female. The bulb measures 0.14 mm. in length and 0.13 mm. in width in the male and 0.3 × 0.25 mm. in the female. The intestinal cæcum runs forward to a point about 0.8 mm. from the anterior end. The cervical papillæ are situated at 0.55–0.8 mm., and the nerve-ring at 0.45–0.65 mm., from the anterior end.

The tail of the male is about 0.11 mm. long. There are four pairs of postanal papillæ, of which the three pairs nearest to the tip of the tail are small, the most posterior being lateral, the others subventral. One large pair projects into the caudal alæ just behind the cloaca. The preanal papillæ consist of five pairs, two just in front of the cloaca and three more pairs of large papillæ more anteriorly at rather wide intervals. The spicules are very long, measuring about 8 mm. The accessory piece, which is 0.3–0.32 mm. long, has a median and two lateral prongs at its free end, which is slightly curved forward. Its solid proximal end is expanded and has a posterior process.

The tail of the female is 0.3 mm. long. The vulva is situated at about 16 mm. from the anterior end. The diameter of the eggs is about 0.075 mm.

2. *Dujardinia woodlandi* Baylis, 1923. (Fig. 44.)

Host :—Gharial (*Gavialis gangeticus*) (stomach).

The male of this species measures about 24–25 mm. in length and 0.6 mm. in maximum thickness, the female up to 60 mm. and 2.5 mm. respectively. The body is apparently not twisted in the regular helicoidal manner of *D. helicina*, but irregularly coiled. The anterior lobes of the dorsal lip are well developed. The pulp of the median lobe appears to be without bifurcated processes. The diameter of the head is 0.14 mm. in the male and 0.3 mm. in the female. The œsophagus, including the bulb, is 2.5–3 mm. long. The bulb measures 0.1–0.15 mm. in length and 0.12–0.22 mm. in width. The intestinal cæcum runs forward to a point 0.77–1.1 mm. from the anterior end. The nerve-ring is situated at 0.5–0.6 mm. from the anterior end, and the cervical papillæ are some distance behind it.

The tail of the male is about 0.1 mm. long. There are ten pairs of caudal papillæ, of which four are postanal, one adanal and five preanal. The four posterior pairs are small, the first and fourth being lateral, the second and third subventral. The spicules are relatively short (1.25 mm.). The accessory piece is almost straight and has a simple tip.

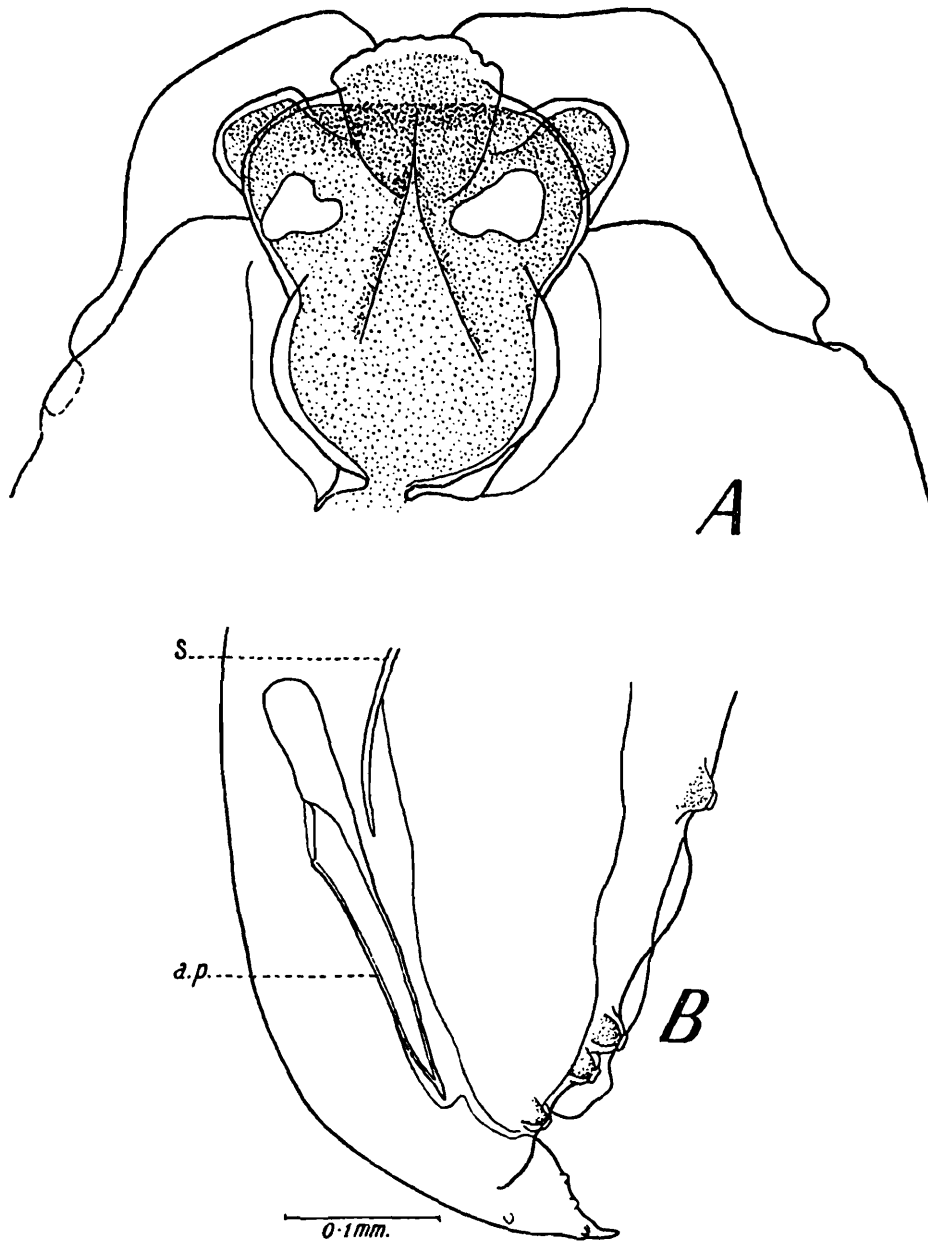

Fig. 44.—*Dujardinia woodlandi*. A, head, dorsal view; B, posterior end of male, lateral view. *a.p.*, accessory piece; *s.*, terminal portion of right spicule. (After Baylis, in 'Parasitology.')

It measures 0.3 mm. in length. Its solid proximal end is not expanded and has no posterior process.

The tail of the female is 0.6–0.7 mm. long. The vulva is situated at about 17 mm. from the anterior end. The eggs have a diameter of 0.06–0.065 mm.

3. *Dujardinia halicoris* (Owen, 1833) Baylis, 1920. (Fig. 45.)

Synonyms :—*Ascaris halicoris* Owen, 1833 ; *Dujardinia halichoris* Baylis, 1920.

Host :—Dugong (*Halicore dugong*) (intestine). Recorded by v. Linstow from the Gulf of Manaar. Specimens in the British Museum (Natural History) from Tirapalakudi, near Ramnad, S. India.

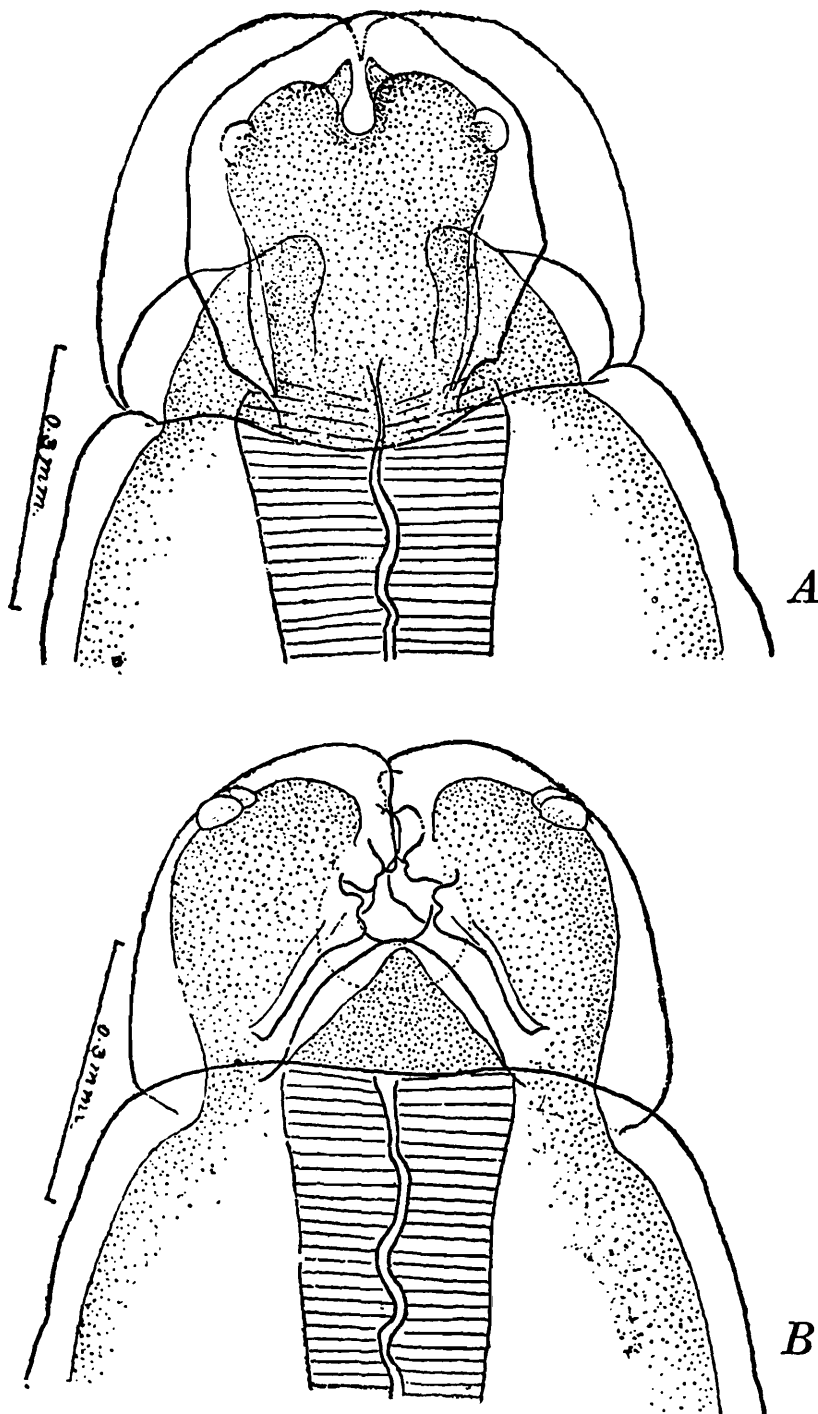

Fig. 45.—*Dujardinia halicoris*. Head of male. A, dorsal view ; B, ventral view. (After Baylis and Daubney.)

The male measures up to 115 mm. in length and 3.16 mm. in thickness, the female up to 144 mm. and 3.95 mm. respectively. The diameter of the head is about 0.7 mm. A well-marked constriction separates the head from the neck. The dorsal lip is almost octagonal in outline, and has two moderately large, simple papillæ. Its pulp has two small, conical, anterior processes which project forwards and inwards. The pulp of each ventro-lateral lip is asymmetrical, the ventral lobe being relatively short and carrying a large, double papilla, while the lateral lobe is long and has a very small papilla at its extremity. There are well-developed interlabia, broad and rounded externally and bluntly conical at their free ends, which converge between the bases of the lips. The œsophagus occupies one-eighth to one-seventh of the total length. Its posterior bulb measures 0.55 mm. in length and 0.6 mm. in width. The intestinal cæcum runs forward to a point about 6 mm. from the anterior end. The nerve-ring is situated at about 1.15 mm., the excretory pore at about 1.2–1.3 mm., and the cervical papillæ at about 1.4–1.5 mm., from the anterior end.

The tail of the male is about 1/146 of the total length. The number of caudal papillæ appears to be normally eight pairs, of which four are postanal and four preanal. The spicules are relatively very short, measuring only 1.1 mm. in length. Each spicule has a tubular shaft, expanded into a funnel at the proximal end, and a pair of alæ, broad distally and much inrolled on the ventral side of the spicule. There is no accessory piece.

The tail of the female is about 1/89 of the total length. The vulva is situated at about the anterior third of the body. The eggs measure about 0.13 mm. in diameter.

7. Genus **MULTICÆCUM** Baylis, 1923.

Lips with dentigerous ridges. Small interlabia present. Well-marked interlabial grooves run from them to the bases of the lips. Œsophagus with a small ventriculus, from which spring two anterior and three posterior appendices. An intestinal cæcum present. Male with an accessory piece. Adult worms in the alimentary canal of crocodiles.

Genotype :—*Multicæcum agile* (Wedl, 1862).

1. **Multicæcum agile** (Wedl, 1862) Baylis, 1923. (Fig. 46.)

Synonym :—*Ascaris agilis* Wedl, 1862.

Hosts :—This species is at present definitely known only from African crocodiles (*Crocodilus niloticus*, *C. cataphractus*). Maplestone (1930), however, has recorded the occurrence

of immature specimens of a species of *Multicæcum* in the stomach of a gharial (*Gavialis gangeticus*) in the Zoological Gardens, Calcutta, and states that, although they were only about half the size of adult specimens of *M. agile*, they appeared to agree in all essential points with that species. "It is possible," he says, "that the present specimens may represent a new species of *Multicæcum*, but in the absence of mature worms it is not possible to be definite on this point."

The following description of African specimens of *M. agile* is given by Baylis (1923) :—

"Length, male, 34.6 mm.; female, 31.6 mm. Maximum thickness, male, 0.65; female, 0.67 mm. (In each case the

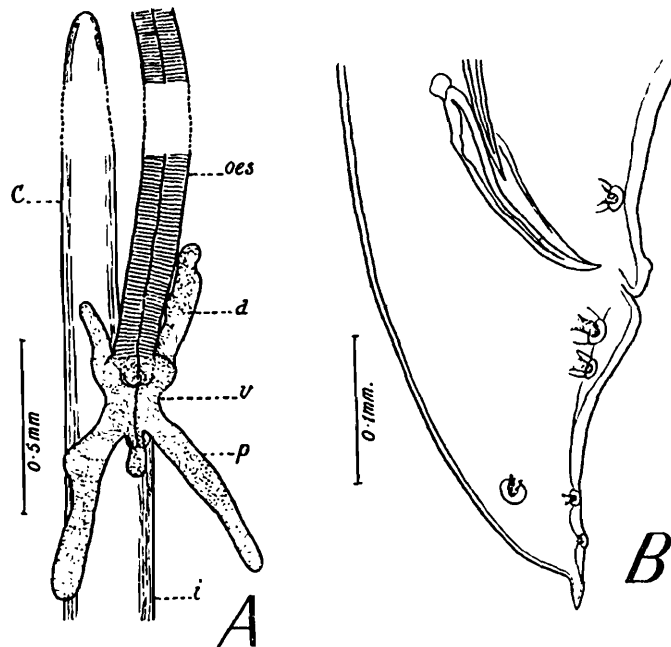

Fig. 46.—*Multicæcum agile*. A, portion of the alimentary canal, showing the posterior part of the œsophagus (*oes.*), the intestine (*i.*) with its cæcum (*c.*), and the ventriculus (*v.*) with its anterior (*a.*) and posterior (*p.*) appendices; B, posterior end of male, lateral view. (After Baylis, in 'Parasitology'.)

specimen was slightly flattened as the result of having been mounted in glycerine-jelly). Diameter of head 0.18–0.19 mm. Length of œsophagus (from anterior extremity) 4.0–4.2 mm. Cervical papillæ at 1.13, nerve-ring at 0.82, excretory pore at 0.85–0.86 mm., from anterior end. Intestinal cæcum extends to 1.4–1.43 mm. from anterior end. Length of œsophageal appendices: anterior, 0.2–0.34 mm.; two outer posterior, 0.42–0.6 mm.; middle posterior, 0.15–0.22 mm. Cuticular striations 4–5 μ apart.

"Tail of male 0.22 mm. long, gently curved ventrally, conically tapering, with suddenly narrower tip. Spicules 1.2 mm. long, rather sharply bent near their roots, which are thickened.

Accessory piece about 0·2 mm. long, with simple tip and a small solid knob at the proximal end. Caudal papillæ ten pairs, five pairs being postanal (of which the first, second, fourth and fifth are subventral, the third lateral) and five preanal. Of the preanal series the first, third and fourth are fairly close together and subventral; the second is large and lateral. The fifth is separated by a considerable interval from the fourth. There is also apparently a median papilla on the anterior lip of the cloaca, but this has not been definitely established, as the male specimen could only be examined in lateral view.

“Tail of female 0·32 mm. long, straight, sharply conical, with suddenly narrower tip. A pair of caudal papillæ at 0·05 mm. from the extremity. Vulva at 15·2 mm. from the anterior end of the body. Ova measure about 0·12 × of 0·085 mm.”

8. Genus **POLYCÆCUM** Maplestone, 1930.

The following definition of the genus is given by Maplestone:—“Mouth surrounded by three lips not separated from the rest of the worm by grooves, and without interlabia. Immediately behind the lips there is a cuticular collar bearing coarser striations than the rest of the body. The œsophageal ventriculus gives off two anterior and three posterior cæca, and there is an intestinal cæcum running forward dorsal to the œsophagus. The vulva opens near the middle of the body. Male unknown.”

Genotype:—*Polycæcum gangeticum* Maplestone, 1930.

1. *Polycæcum gangeticum* Maplestone, 1930. (Fig. 47.)

Host:—Gharial (*Gavialis gangeticus*) (intestine); Zoological Gardens, Calcutta.

The following description, based on a single immature female, is quoted from Maplestone (1930). The author notes that the dimensions of fully-grown specimens would probably be greater than those given.

“The worm is 11·5 mm. in length and 0·226 mm. in greatest diameter. The mouth is surrounded by three lips not marked off by a groove from the body, and there are no interlabia. The dorsal lip is triangular in shape and the subventral lips are broad and crescentic, the tips being formed by clear cuticular caps. Immediately behind the lips there is a circular swelling, which is more pronounced dorsally and laterally than it is ventrally. The whole cuticle is covered by transverse striations, which are distinctly coarser on the cephalic swelling than they are on the rest of the body. The

excretory pore opens 0.416 mm. from the anterior end. The œsophagus is long and straight and measures 2.675 mm. in length. It ends in a short ventriculus, which gives off five cæca; the two anterior cæca are very unequal, and of the three posterior cæca the central one is much shorter than the other two. The longer anterior cæcum and the two longer posterior cæca are about 0.396 mm. in length. There is also a long intestinal cæcum running forward dorsal to the œsophagus and about 1.98 mm. in length. The vulva opens exactly in the middle of the body, being 5.75 mm. from the anterior end. The vagina runs posteriorly from the vulva. The tail is straight and ends in a blunt tip surmounted by a fine cuticular

Fig. 47.

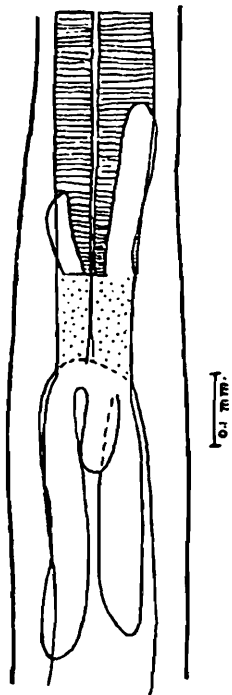

Fig. 48.

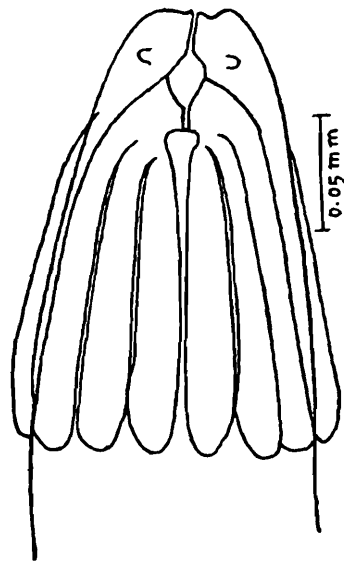

Fig. 47.—*Polycæcum gangeticum*. Portion of œsophagus and intestine, showing ventriculus and appendices. (After Maplestone.)

Fig. 48.—*Typhlophoros lamellaris*. Anterior end; ventral view. (After Maplestone.)

point. The distance from the anus to the tip of the tail is 0.176 mm., and there is a long cuticular rectum connecting it with the termination of the intestine. No eggs are present."

The reasons for erecting a separate genus for this species were presumably the structure of the head, the apparent absence of interlabia and the presence of a cuticular swelling behind the head. It may be observed, however, that as regards the rest of its structure this worm is extremely similar to *Multicæcum*, and it even seems possible that the peculiarities mentioned may be larval characters, and that the specimen may be an immature individual of *Multicæcum agile* or of a closely-related species.

9. Genus **TYPHLOPHOROS** v. Linstow, 1906.

Lips without dentigerous ridges, not separated from the body by a groove, but narrowed at their bases and with pulps widened in front. Interlabia absent. Behind the lips a cuticular collar consisting of sixteen transversely striated longitudinal folds. Lateral alæ present on the body. Œsophagus with a small ventriculus which, as in *Multicæcum*, gives off two anterior and three posterior appendices. An intestinal cæcum present. Male with four pairs of preanal papillæ. Spicules equal. Vulva at about the middle of the body or a little in front of it. Eggs thick-shelled. Adult worms in stomach of gharial.

Genotype:—*Typhlophoros lamellaris* v. Linstow, 1906.

1. **Typhlophoros lamellaris** v. Linstow, 1906. (Fig. 48.)

Host:—Gharial (*Gavialis gangeticus*) (stomach); Zoological Gardens, Calcutta (recorded by v. Linstow and by Maplestone).

Maplestone (1930) obtained a few female specimens of this species, only one of which appeared to be mature. He was thus able to amplify or correct the description given by v. Linstow in certain particulars, but no full description of the species is yet available.

According to v. Linstow, the male is 11 mm. long and 0.31 mm. in thickness, the female 16 mm. and 0.32 mm. respectively. The cephalic collar is 0.12 mm. long. In Maplestone's specimen the œsophagus measured 1.78 mm. in length. The ventriculus, which arose from the ventral surface of the œsophagus, measured 0.128 mm. from the ends of the anterior to the ends of the posterior appendices. The intestinal cæcum, which according to v. Linstow extends right to the anterior end of the body, ended in Maplestone's specimen at 0.475 mm. from the anterior end.

The tail of the male, according to v. Linstow, is $\frac{1}{141}$ of the total length of the body. The spicules are 0.6 mm. long.

v. Linstow states that in the female there are two roundish preanal projections, but Maplestone was unable to observe these. The tail of the female occupies $\frac{1}{80}$ of the total length according to the former author, or 0.208 mm. according to Maplestone. The vulva is situated at 7.65 mm. from the anterior end in a specimen 15 mm. long, according to Maplestone, or, according to v. Linstow, somewhat in front of the middle of the body, dividing the total length in the proportion of 4:5. The eggs, according to v. Linstow, measure 0.073×0.062 mm.

10. Genus **AMPLICÆCUM** Baylis, 1920.

Lips with dentigerous ridges. Small interlabia present. Œsophagus without ventriculus or distinct bulb. No œsophageal appendix. A wide intestinal cæcum present. Adult worms in the alimentary canal of birds of prey, reptiles and amphibians.

Genotype :—*Amplicæcum colurum* (Baylis, 1919).

1. **Amplicæcum varani** Baylis and Daubney, 1922. (Figs. 49 & 50.)

Host :—The common water-monitor (*Varanus salvator*) (intestine); Zoological Gardens, Calcutta.

The male measures 22·2–24·9 mm. in length, the female 24·75 mm. The greatest thickness is 0·73 mm. in the male, 0·8 mm. in the female. The diameter of the head is 0·25–0·29 mm. The cuticular striations are fine (about 5 μ apart). The lips are nearly square in outline. They have a deep indentation on the inner surface at the anterior margin. The interlabia are very small, and are almost hidden by the lips. There are well-marked interlabial grooves, which nearly meet on the outer surface of the base of each lip. The grooves have prominent, membranous, cuticular borders posteriorly. The dorsal lip has two moderately large papillæ. Each ventro-lateral lip has one large, lozenge-shaped papilla towards the ventral side and one very small papilla laterally. The œsophagus measures 3·5–4·7 mm. in length. The well-developed, but rather narrow, intestinal cæcum is 0·9–1 mm. long. The cervical papillæ, which are very small, are situated at about 0·9 mm., the nerve-ring at 0·7–0·74 mm., and the excretory pore at 0·9 mm., from the anterior end.

The tail of the male is conical and 0·16 mm. long. There are five pairs of postanal papillæ, of which the first and third from the tip of the tail are ventral, the rest lateral in position. There are about 32 pairs of preanal papillæ, those nearest to the cloaca being very small, the more anterior much larger. There is also a small, median papilla on the anterior lip of the cloaca. The spicules are equal and remarkably short (0·5 mm.), and are simple, cylindrical, slightly tapering rods.

The tail of the female is conically pointed and 0·32 mm. long. There is a pair of caudal papillæ at 0·065 mm. from the tip. The vulva is situated at 6·5 mm. from the anterior end of the body (a little behind the anterior quarter). There is a long, muscular vagina, which follows a very irregular course in a generally posterior direction. The two uterine branches are wide and thin-walled, and run backward with

Fig. 49.

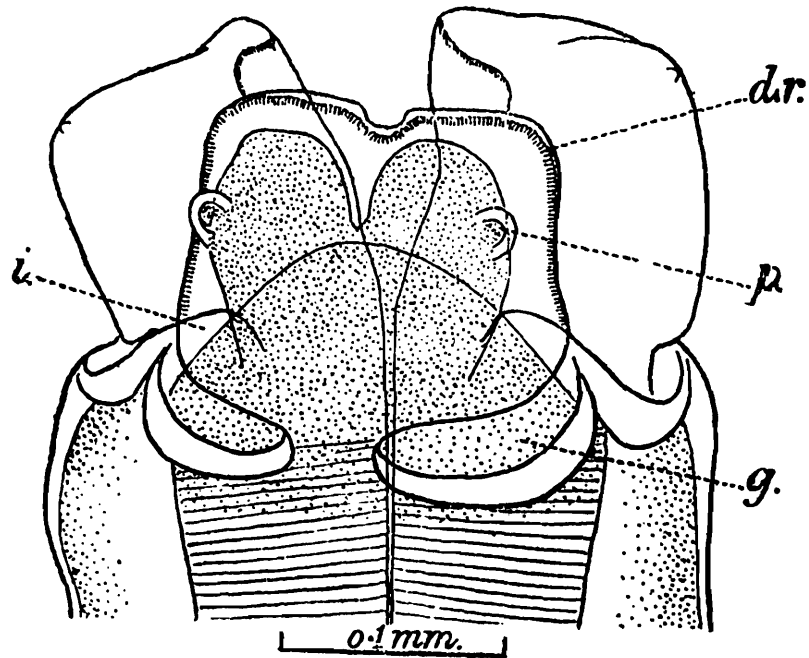
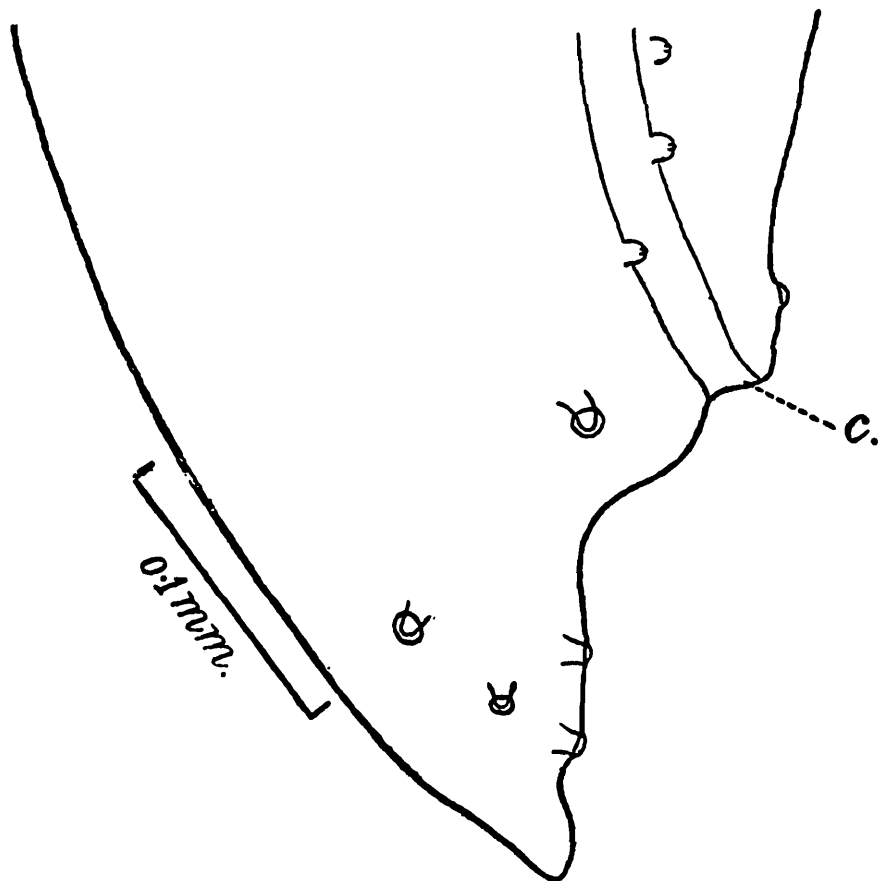

Fig. 50.



- Fig. 49.—*Amplicæcum varani*. Head of female; dorsal view. *d.r.*, dentigerous ridge; *g.*, interlabial groove; *i.*, interlabium; *p.*, papilla. (After Baylis and Daubney.)
- Fig. 50.—*Amplicæcum varani*. Posterior end of male; lateral view. *c.*, cloacal aperture. (After Baylis and Daubney.)

a rather sinuous course. The coils of the ovaries occupy the posterior region of the body, as far back as about 1.5 mm. from the tip of the tail. The eggs are oval and have rather thin shells measuring 0.0675–0.075 × 0.05 mm.

11. Genus **GOEZIA** Zeder, 1800.

Synonyms :—*Cochlus* Zeder, 1803 ; *Prionoderma* Rudolphi, 1810, nec Cuvier, 1817 ; *Lecanocephalus* Diesing, 1839.

Lips flattened anteriorly and expanded outwards, separated from the body by a constriction. Cuticle with a series of transverse rings bearing backwardly-directed spines on their posterior edges. Oesophagus slightly constricted in the middle and swollen gradually into a bulb behind, and giving off posteriorly a long appendix. A short intestinal cæcum present. Tail rounded and in both sexes prolonged into an appendage. Spicules subequal. Vulva a little in front of the middle of the body. Eggs globular. Adult worms in the alimentary canal of fishes [and crocodiles (?)].

Genotype :—*Goezia ascaroides* (Goeze, 1782).

1. *Goezia gavialidis* Maplestone, 1930. (Fig. 51.)

Host :—A single female specimen is recorded by Maplestone from the stomach of a gharial (*Gavialis gangeticus*) in the Zoological Gardens, Calcutta. He suggests, with some probability, that the worm may have been a “pseudoparasite,” having merely been liberated by digestion from some fish eaten by the gharial. The hosts of all the other known species of *Goezia* are fishes.

Maplestone describes the specimen as follows :—

“The worm is 6.6 mm. in length, and 0.6 mm. in maximum diameter, which is well behind the middle of the worm. The anterior end is bluntly rounded and it is surmounted by three large lips. The dorsal lip appears as a large oval pulpy mass surrounded by thick cuticle, and two pointed papillæ arise from its inner surface. The subventral lips each have a prominent angle which curves outwards and backwards.

“The cuticle is covered with prominent circular striations about 0.048 mm. apart and which bear on their posterior borders rows of finely pointed spines directed backwards. These striations and spines extend for the whole length of the worm, and are of approximately the same size, except on the tail itself where the striations are closer together and the spines are very minute. The vulva opens 2.8 mm. from the anterior end. The vagina is a much convoluted tube which curves forward only a little distance in front of the vulva.

it then bends backwards and divides into the two uteri. These tubes pursue a posterior course and finally enter the ovaries, which run a very convoluted course almost to the posterior end of the worm. The œsophagus is 0.75 mm. in length with a very slightly marked posterior bulb. There is a long thin glandular appendix, which arises from the posterior end of the œsophagus and is 1.5 mm. in length.

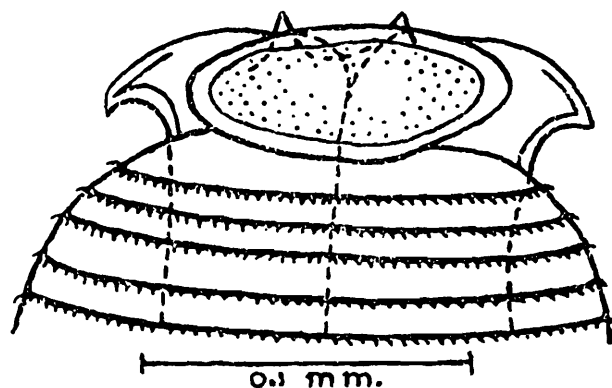

Fig. 51.—*Goezia gavialedis*. Head; dorsal view.
(After Maplestone.)

There is also a short diverticulum, which arises from the intestine at its junction with the œsophagus and which runs forwards for about 0.2 mm. The intestine is thin-walled with a very wide lumen. It ends in an anus which is 0.2 mm. from the tip of the tail. The worm is broad to behind the anus, a little distance posterior to which it suddenly becomes narrower to end in a relatively long thin point."

APPENDIX TO THE FAMILY ASCARIDÆ.

Certain forms are placed here whose systematic position it is at present impossible to determine.

1. "*Ascaris*" *cynonycteridis* Paron³, 1889.

Host:—A bat (*Xantharpyia* [*Cynonycteris*] *amplexicaudata*) (stomach); Farm Caves, Moulmein, Northern Tenasserim, Burma.

The only description of this species available appears to be that of Paron (1889). According to this the male is 50 mm. long, the female 60–65 mm. The thickness is 2 mm. in the largest female. The body is more slender in front than behind, and is quite smooth. The diameter of the head (in the female) is 0.098 mm. The dorsal lip is "not denticulate," but has "oval anterior projections" and two papillæ. The ventro-lateral lips have two conical tubercles (the figure shows a pair of what appear to be prominent papillæ, one on each side of the head). The œsophagus

(called by Parona the "pharynx") is about 2 mm. long, "con bulbo quasi nullo." The intestine is wide.

The tail of the male is mucronate and bears one pair of prominent postanal papillæ. There are also four pairs of preanal papillæ. The "spicule-sheath" measures 0.042 mm. and contains two equal spicules which are curved and protruded, and about twice as long as the sheath.

The tail of the female is blunt but mucronate. The vulva is situated at 5 mm. from the anterior end.

2. "*Ascaris*" *brachyura* v. Linstow, 1904.

Host :—The "bloodsucker" (*Calotes versicolor*) (intestine); Colombo, Ceylon.

Of this species the only description available is that of v. Linstow. The male measures 31.6 mm. in length and 0.91 mm. in maximum thickness, the female 34.3 mm. and 0.86 mm. respectively. The cuticle is broadly annulate. The lips are provided with dentigerous ridges having long and sharply pointed denticles. There are no interlabia. The dorsal lip measures 0.097 mm. in length and 0.176 mm. in width, and has a concave anterior margin. Its papillæ are large and obliquely placed. The œsophagus occupies 1/15–1/14 of the total length. The description makes no mention of a ventriculus or of an œsophageal appendix or intestinal cæcum.

The tail, in both sexes, is very short and rounded. In the male it occupies 1/267 of the total length, and has a fine terminal spike. There are two pairs of postanal and 22 pairs of preanal papillæ. The spicules measure 0.62 mm. in length and are falciform, with rounded tips.

The tail of the female occupies 1/200 of the total length and is without a terminal spike. The vulva is situated somewhat in front of the middle of the body, dividing the total length in the ratio of 3:5. The genital tubes are confined to the posterior two-thirds of the body. Fully-formed eggs were not observed.

3. "*Ascaris*" *tigridis* Gmelin, 1790.

Synonym :—*Fusaria tigridis* Zeder, 1803.

Host :—Tiger (*Felis tigris*).

It is quite impossible to identify this species, which Gmelin based on a figure given by Redi. This purports to show the alimentary canal of the worm, which is provided near the posterior end with two rather long, blind appendages. There is no further description. Rudolphi (1819) states that he has seen a specimen of the worm in the Vienna Museum.

This was five lines long and had a blunt, alate head and a pointed tail. Diesing (1851), however, states that this specimen was the female of some Strongylid. Leiper (1907) refers *A. tigridis* to *Toxascaris*, but there is no evidence to support this view of its position.

2. Family HETERAKIDÆ Railliet and Henry, 1914.

Medium-sized or rather small parasitic forms. Musculature of the body of the polymyarian type. Lips typically well defined, but sometimes much reduced. Either a chitinous buccal capsule is present or the anterior portion of the œsophagus is differentiated as a small muscular pharynx. The posterior end of the œsophagus is almost always enlarged to form a subglobular muscular bulb containing a three-sided valvular apparatus. There is a more or less well developed preanal sucker in the male, with or without a chitinous border, and provided with special musculature. There are usually two spicules, but one or both of them may be imperfectly chitinized or occasionally absent. An accessory piece may be present or absent. The vulva is typically near the middle of the body. The worms are oviparous. The life-history is direct, without intermediate host.

Subfamily HETERAKINÆ Railliet and Henry, 1912.

Lips well defined. Buccal capsule absent. Œsophagus with a pharynx and a posterior bulb, except in *Ascaridia*. Preanal sucker nearly circular, with chitinous border. Vulva in or near the middle of the body. Eggs usually unsegmented when laid.

Key to Genera.

Œsophagus without posterior bulb	ASCARIDIA, p. 133.
Œsophagus with a posterior bulb	1.
1. Caudal papillæ of male sessile	2.
Caudal papillæ of male mainly pedunculate.	3.
2. Male with an accessory piece	SPINICAUDA, p. 147.
Male without accessory piece	AFRICANA, p. 149.
3. Lips with "cordons" *	PSEUDASPIDODERA,
Lips without "cordons"	4. [p. 127.
4. Caudal end of male tapering; pharynx relatively short, with straight lumen	HETERAKIS, p. 111.
Caudal end of male obliquely truncate; pharynx relatively long, with a ventral "kink" in its lumen posteriorly	STRONGYLURIS, p. 142.

* Grooves, tubular channels or festoon-like ornaments in or on the cuticle.

1. Genus **HETERAKIS** Dujardin, 1845.

Synonyms :—*Ganguleterakis* Lane, 1914; *Gireterakis* Lane, 1917; *Meteterakis* Karve, 1930.

Lips without "cordons." Body usually with well-developed lateral alæ. Anterior end usually curved dorsally. Caudal alæ of male very well developed and supported by several pairs of pedunculate papillæ. Spicules equal, subequal or markedly unequal in length and sometimes dissimilar in form. No accessory piece. Branches of uterus either actually or apparently opposed*. In some species papilla-like protuberances may be seen in the neighbourhood of the vulva in mature females. These are probably produced by the action of the sucker of the male. Eggs with thick shells, their contents unsegmented at the time of laying. Adult worms in the alimentary canal of birds, mammals and batrachians.

Genotype :—*Heterakis gallinæ* (Gmelin, 1790).

Lane (1914, *b*; 1917, *b*) proposed the genera *Ganguleterakis* and *Gireterakis* for the reception of certain species which differed from the genotype of *Heterakis* mainly in having an atypical number and arrangement of caudal papillæ in the male. As a generic character neither the number nor the precise arrangement of the papillæ appears to be satisfactory. All the species that are typical in the sense of having twelve pairs of papillæ are parasitic in birds, but a number of species from birds have been described as having more or less than this number of papillæ, and even when the number is typical there is considerable variety in the arrangement. This being so, although the type-species of Lane's genera are both parasitic in mammals, the validity of the genera seems very questionable. A better case might be made out for the retention of the genus *Meteterakis* Karve, 1930, in whose genotype (which is a parasite of a batrachian) not only are there at least 17 pairs of papillæ, but their arrangement is very unusual, with several pairs placed anteriorly to the caudal sucker. In the absence of more important characters, however, the writer prefers for the present to regard all these forms as belonging to the old genus *Heterakis*.

Key to Species.

Parasite of Amphibia	<i>govindi</i> , p. 126.
Parasites of birds ..	1.
Parasites of mammals ..	11.
1. Spicules of male markedly unequal in length.	2.
Spicules of male equal or subequal	8.

* In the latter case the branches are parallel at their origin, but one almost immediately doubles back upon itself and runs in the opposite direction.

- | | |
|---|-------------------------------|
| 2. Longer spicule about 2 mm. long | 3. |
| Longer spicule about 1 mm. long, or less | 5. |
| 3. Shorter spicule with a double curve near the tip | <i>gallinæ</i> , p. 112. |
| Shorter spicule with a barb near the tip | 4. |
| 4. Longer spicule with simple point; barb of shorter spicule small | <i>pavonis</i> , p. 115. |
| Tip of longer spicule shaped like a spear-head; barb of shorter spicule large and massive | <i>bosia</i> , p. 116. |
| 5. Longer spicule about 1 mm. long; shorter spicule about 0.3–0.4 mm. long | <i>indica</i> , p. 115. |
| Longer spicule considerably less than 1 mm. long | 6. |
| 6. Longer spicule little over 0.3 mm. long | <i>parva</i> , p. 118. |
| Longer spicule 0.5 mm. or more in length | 7. |
| 7. Shorter spicule about 0.3 mm. long | <i>vulvolabiata</i> , p. 118. |
| Shorter spicule 0.15 mm. long | <i>pusilla</i> , p. 116. |
| 8. Spicules about 2 mm. long | <i>isolonche</i> , p. 119. |
| Spicules much less than 2 mm. long | 9. |
| 9. Spicules about 0.4–0.6 mm. long; diameter of preanal sucker over 0.1 mm. | <i>papillosa</i> , p. 121. |
| Spicules less than 0.4 mm. long; diameter of preanal sucker less than 0.1 mm. | 10. |
| 10. Left spicule with a prominent ventral angle near the tip | <i>beramporia</i> , p. 122. |
| Left spicule without ventral angle | <i>hamulus</i> , p. 123. |
| 11. Parasite of rats | <i>spumosa</i> , p. 123. |
| Parasite of porcupine | <i>girardi</i> , p. 125. |

1. **Heterakis gallinæ** (Gmelin, 1790) Freeborn, 1923. (Figs. 52 & 53.)

Synonyms* :—*Ascaris gallinæ* Gmelin, 1790; *Ascaris vesicularis* Frölich, 1791 (part); *Heterakis vesicularis* Dujardin, 1845; *Heterakis longicaudata* v. Linstow, 1879; *Heterakis papillosa* auctt. (not Railliet, 1885 = *Ascaris papillosa* Bloch, 1782 (part), nec Molin, 1860); ? *Heterakis parisi* Blanc, 1913.

Hosts :—This species is of cosmopolitan distribution, and is one of the commonest parasites of domestic poultry (fowl,

* The species *H. longicaudata* v. Linstow, originally recorded from *Megacephalon maleo*, a bird found in Celebes, was regarded by Baylis and Daubney (1922) as distinct from *H. gallinæ*. Maplestone (1932, a) considers these species identical, and before his paper appeared the writer had come to the same conclusion. Some experiments were made in preserving specimens of *H. gallinæ* by different methods, and the results suggested that the characters supposed to be distinctive of *H. longicaudata* were simply due to fixation in cold alcohol. In male specimens so preserved the tail is somewhat contracted, and the alæ appear relatively broader, while the diameter of the sucker seems to be greater than in worms killed in hot alcohol. *H. parisi* Blanc is recorded from *Rhea americana* in captivity in France. As Maplestone has also pointed out, it does not appear to differ in any important respect from *H. gallinæ*. The writer has examined specimens of *Heterakis* from a rhea in captivity in England, and was unable to distinguish them from *H. gallinæ*.

turkey, guineafowl, peafowl, and occasionally duck and goose). It has been recorded from the fowl in Calcutta by Maplestone, and also from a considerable number of other birds, mostly Galliformes, in the Zoological Gardens, Calcutta, by Baylis and Daubney, Chandler, and Maplestone. These hosts include the following :—Ring-necked pheasant (*Phasianus torquatus*), kalij (*Gennæus leucomelanos*), monál (*Lophophorus impejanus*), crimson horned pheasant (*Tragopan satyra*), silver pheasant (*Gennæus nycthemerus*), golden pheasant (*Chrysolophus [Thaumalea] pictus*), red spur-fowl (*Galloperdix spadicea*),

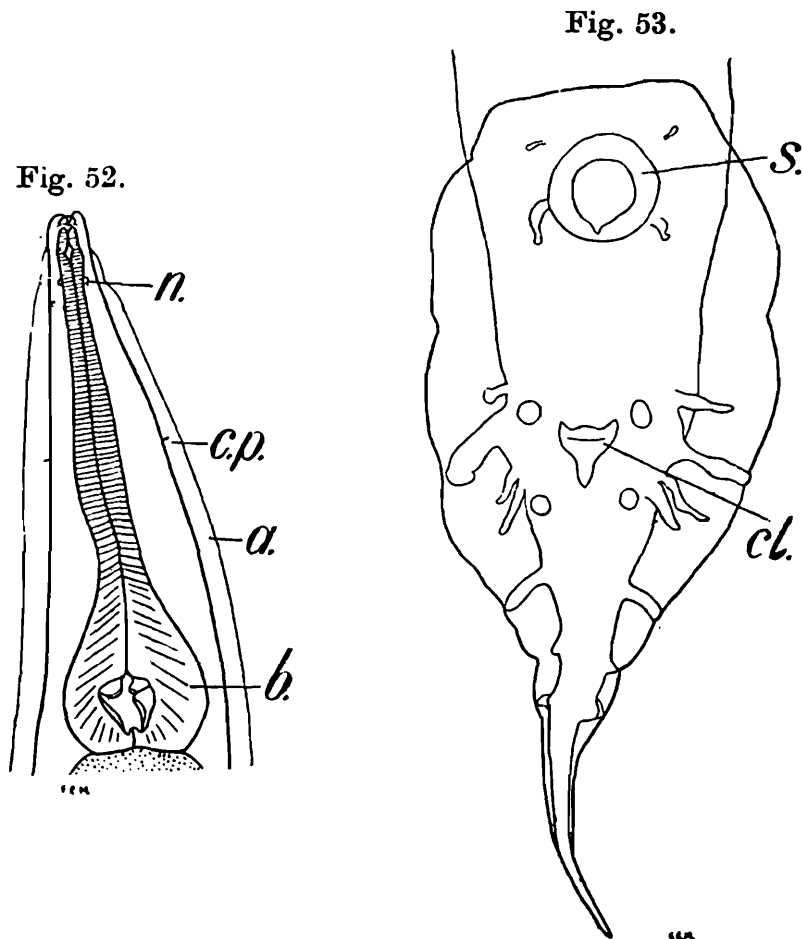

Fig. 52.—*Heterakis gallinæ*. Anterior end; dorsal view. *a.*, cervical ala; *b.*, oesophageal bulb; *c.p.*, cervical papilla; *n.*, nerve-ring. (From Baylis, after Yorke and Maplestone.)

Fig. 53.—*Heterakis gallinæ*. Posterior end of male; ventral view. *cl.*, cloacal aperture; *s.*, sucker. (From Baylis, after Lane.)

crested fire-back (*Lophura rufa*), common hill-partridge (*Arborophila torqueola*), swamp-partridge (*Francolinus gularis*), chukar partridge (*Alectoris græca chukar*), vulturine guinea-fowl (*Acryllium vulturinum*) and houbara (*Chlamydotis undulata macqueeni*).

The male measures about 7–13 mm. in length, the female about 8–15 mm. The maximum thickness is about 0.24–0.4 mm. The cuticular striations are extremely fine. The

œsophagus, including the bulb, is about 1–1.1 mm. long. Of this length the pharynx, which is narrower than the œsophagus proper, occupies about 0.08–0.09 mm. The bulb is 0.18–0.25 mm. in diameter. The nerve-ring is situated at about 0.3 mm., the excretory pore at 0.45–0.5 mm., and the cervical papillæ at about 0.55 mm., from the anterior end.

The caudal alæ of the male are broad. The tail (*i. e.* the postanal portion of the body) is about 0.3–0.5 mm. long, and tapers beyond the alæ to a fine filament. The chitinoid border of the preanal sucker measures about 0.06–0.1 mm. in outside diameter, and has a small indentation on its inner side posteriorly. The sucker is situated at a distance of 0.1–0.2 mm. from the cloacal aperture. There are twelve pairs of caudal papillæ, of which five pairs have long peduncles and project into the alæ. The arrangement of the papillæ, which is typical of most of the species of *Heterakis* occurring in birds, will be best understood from the figure (fig. 53). Following the nomenclature of Lane (1914, *b*; 1917, *b*), the two pairs at the sides of the sucker may be called the "parasuctorial" papillæ, the group surrounding the cloacal aperture the "paracloacal," the group near the posterior end of the alæ the "caudal," and the isolated pair between these and the paracloacal group the "intermediate" papillæ.

The spicules are unequal and dissimilar, the right being, as in most species of this genus, the longer. Both are alate. The left spicule is 0.6–1.3 mm. long, and has very broad alæ which do not extend quite to the distal end. Its tip forms a very characteristic double curve. The right spicule is about 1.6–2.6 mm. long, and has narrower alæ and a simple, conical tip.

The tail of the female is tapering and sharply pointed, and measures about 1–1.2 mm. in length. There is a pair of caudal papillæ at about 0.68 mm. from the posterior end. The vulva is situated slightly behind the middle of the body, at 3.7–4.75 mm. from the posterior end. The vagina is long, its terminal portion running posteriorly from the vulva. After forming several antero-posterior loops, the uterus runs straight back to a point about 1.5 mm. from the anus, where it divides into two apparently opposed branches. The greater part of the coils of both ovaries lies in the anterior region of the body, between the vulva and the hinder end of the œsophagus. The eggs are somewhat oblong, with a thick shell which may be slightly thickened at one pole. They measure about 0.063–0.075 × 0.036–0.048 mm.

H. gallinæ usually lives in the cæca of its hosts, but is sometimes found in the small and large intestines. The eggs, when passed in the droppings, have unsegmented contents. Under favourable conditions an infective embryo is

developed in seven to twelve days, and if the egg be swallowed by a suitable host this embryo hatches and develops to maturity in 24 days. For the first few days after infection the young worms are chiefly found burrowing in the mucous membrane of the cæca, or in the cæcal glands. Later they emerge and live in the lumen.

2. *Heterakis indica* Maplestone, 1932.

Hosts :—This species was found by Maplestone in fowls obtained in a market in Calcutta, and occurred, in association with *H. gallinæ*, in four out of thirty infected birds.

Maplestone states that, apart from measurements, the only characters in which he found this form to differ from *H. gallinæ* were the shape of the tip of the shorter spicule (which is figured as being bifid) and the fact that the caudal alæ of the male met on the ventral surface in front of the sucker.

The male measures 5.6–7.2 mm. in length and 0.22–0.28 mm. in maximum thickness, the female 7.12–7.38 mm. and 0.25–0.32 mm. respectively.

The caudal papillæ of the male are as in *H. gallinæ*. The sucker has a diameter of 0.064–0.076 mm. The spicules measure respectively 0.297–0.396 mm. (approximately 0.3–0.4 mm.) and 0.99–1.19 mm. (approximately 1–1.2 mm.).

The eggs measure 0.062–0.068 × 0.032–0.036 mm.

3. *Heterakis pavonis* Maplestone, 1932.

Host :—Silver pheasant (*Gennæus nycthemerus*) ; Zoological Gardens, Calcutta.

Maplestone states that this species superficially resembles *H. gallinæ*, but that the shorter spicule has a barb similar to that described in *Pseudaspidodera pavonis* (vide infra). “ No other morphological differences between this worm and *H. gallinæ* could be discovered, except that possibly the notches at the bases of the lips appeared to be slightly better marked, and the dorsal lip appears to be more rounded in *H. pavonis*, but these differences are so slight as to be of doubtful value as distinguishing characters.”

The male measures 6.8–7.2 mm. in length and 0.25–0.27 mm. in maximum thickness, the female 8.8–10.1 mm. and 0.36–0.44 mm. respectively. The length of the œsophagus is 0.94–1 mm. in the male and 1.3–1.4 mm. in the female. The diameter of the œsophageal bulb is 0.14–0.16 mm. in the male and 0.22–0.26 mm. in the female.

The tail of the male is 0.44–0.475 mm. long. The sucker has a diameter of 0.068–0.072 mm., and is situated at a distance of 0.11–0.12 mm. from the cloacal aperture. The

spicules measure respectively 0.594–0.673 mm. and 1.68–1.89 mm. (or approximately 0.6–0.7 mm. and 1.7–1.9 mm.).

The tail of the female is 0.91–1.07 mm. long. The eggs measure 0.068–0.076 × 0.038–0.044 mm.

4. *Heterakis pusilla* v. Linstow, 1906.

Host:—Jungle fowl (*Gallus lafayetii*) (cæca); Mamadu, Northern Province, Ceylon.

The only existing description of this species is that originally given by v. Linstow. The male measures 5 mm. in length and 0.19 mm. in maximum thickness, the female 5.13 mm. and 0.24 mm. respectively. The lips are small and rounded. The cuticle is said to be smooth. The œsophagus is “thickened, club-shaped behind,” and occupies in the male $\frac{1}{5}$, in the female $\frac{1}{5.8}$, of the total length.

The tail of the male is $\frac{1}{12}$ of the total length and is finely pointed. The size of the preanal sucker is not given. The only caudal papillæ mentioned are four pairs of lateral postanal papillæ, the most posterior papilla on each side separated by a greater distance from the third than are the first three from each other. The spicules are very unequal in length, the left measuring 0.53 mm., the right 0.15 mm.

The tail of the female is long ($\frac{1}{9.5}$ of the total length) and pointed. The vulva lies considerably behind the middle of the body, dividing the total length in the proportion of 12 : 5. The eggs measure 0.065 × 0.031 mm.

5. *Heterakis bosia* Lane, 1914. (Fig. 54.)

Host:—Crimson horned pheasant (*Tragopan satyra*); Zoological Gardens, Calcutta (Lane, Baylis and Daubney, Maplestone).

The male measures about 8–9.8 mm. in length, the female 9.5–11.1 mm. The maximum thickness is about 0.26–0.47 mm. The cuticular striations are at intervals of about 2μ . Lateral alæ are present, beginning at about 0.2 mm. from the anterior end and extending in the male to about the level of the sucker, and in the female to within about 0.03 mm. of the tip of the tail. The œsophagus measures 1.3–1.55 mm. in length, the pharynx occupying 0.1 mm. and the bulb 0.45 mm. The diameter of the latter is given by Maplestone as 0.22–0.34 mm. The nerve-ring, according to Lane, is situated at 0.33 mm., the excretory pore at 0.6 mm., and the cervical papillæ at 0.65 mm., from the anterior extremity.

The tail of the male is about 0.55–0.69 mm. long. The sucker has a diameter of 0.11–0.128 mm., and is situated at a distance of about 0.15 mm. from the cloacal aperture. The twelve pairs of caudal papillæ are arranged as in *H. gallinæ*. The

left spicule measures about 0.9–1 mm. in length. “At a point about a quarter of its length from the point, it expands abruptly on one side only, so that a one-sided barb is formed” (*Lane*). The right spicule is about 1.5–1.85 mm. long. “For its last 0.5 mm. it expands into a portion shaped like a spear-head, which however is not quite symmetrical, measures 0.075 mm. in width, narrows sharply and is then projected into a fairly long sharp point.” (*Lane*).

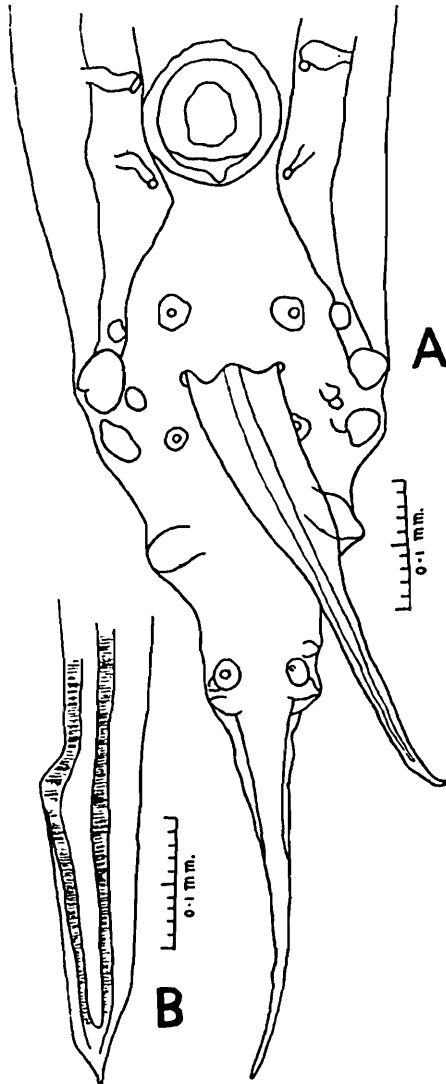

Fig. 54.—*Heterakis bosia*. A, posterior end of male; ventral view, showing point of right spicule. B, tip of left spicule; dorsal view. (After *Lane*.)

The tail of the female is about 1.2–1.5 mm. long, and bears a pair of papillæ at 0.8 mm. from its tip. The vulva is just behind the middle of the body. Papilla-like tubercles may or may not be present in its vicinity*. The eggs measure 0.068–0.08 × 0.035–0.04 mm.

* Such tubercles are often present near the vulva of many species of *Heterakis*, and are probably produced by the sucker of the male.

6. *Heterakis vulvolabiata* Chandler, 1926.

Synonym :—*Heterakis vulvolabita* Chandler, 1926.

Host :—Black-throated hill partridge (*Arborophila torqueola*) (cæca and large intestine); Zoological Gardens, Calcutta (Chandler, Maplestone).

The male measures about 6–7 mm. in length and about 0·25 mm. in maximum thickness, the female 7–8 mm. and 0·265 mm. respectively. The diameter of the head (in the male) is about 0·055 mm. The lips are semiglobular, without prominent papillæ. The lateral alæ are narrow. The œsophagus is about 0·78–0·875 mm. long, the pharynx 0·07 mm. and the bulb 0·21–0·235 mm. The latter is 0·15–0·17 mm. wide.

The tail of the male measures 0·23–0·32 mm. in length, the slender portion behind the papillæ occupying only 0·07 mm. The preanal sucker is small, measuring only about 0·05 mm. in diameter, and is situated at 0·08–0·096 mm. from the cloacal aperture. There are thirteen pairs of caudal papillæ. Their arrangement is as usual in the genus, except that the “paracloacal” group includes seven pairs. Two of these are subventral and five lateral. Of the latter the first and fourth are smaller than the others. The spicules are very unequal and dissimilar. The left is 0·29–0·32 mm. long and about 0·018 mm. wide. The right is extremely slender and bristle-like, 0·535–0·6 mm. long and only 3μ thick at its middle and about 9μ at its root.

The tail of the female is about 0·54 mm. long, tapering for a distance of about 0·39 mm. and then ending in a thin, sharp point. The vulva is considerably behind the middle of the body, dividing the total length in the proportion of about 7 : 5·5. Its lips are prominent, projecting from the body-wall for a distance of about 0·02 mm. “The ovejector makes a prominent loop in the region of the vulva giving the effect of a more or less hemispherical body” (Chandler). The eggs measure about 0·055–0·06 × 0·035 mm.

7 *Heterakis parva* Maplestone, 1931.

Host :—Silver pheasant (*Gennæus nycthemerus*); Zoological Gardens, Calcutta.

The male measures 4·68 mm. in length and 0·247 mm. in maximum thickness, the female 6·03 mm. and 0·376 mm. respectively. The lips are not separated from the body by a groove. There are no lateral alæ. The œsophagus, including the bulb, is 0·634–0·673 mm. long, the pharynx occupying 0·044 mm.

The tail of the male is 0.356 mm. long. The preanal sucker has a diameter of 0.062 mm., and is situated at 0.118 mm. from the cloacal aperture. There are fourteen pairs of caudal papillæ, the "paracloacal" group including seven pairs (four lateral, three subventral), and a small subventral pair being present near the bases of the isolated lateral pair between this group and the posterior group. "The spicules are similar in shape but unequal, one being 0.317 and the other 0.277 mm. in length."

The tail of the female is 0.594 mm. long. The vulva is situated at 2.65 mm. from the posterior end, and has slightly prominent lips. The eggs measure 0.06–0.062 × 0.032–0.034 mm.

8. *Heterakis isolonche* v. Linstow, 1906. (Fig. 55.)

Synonyms* :—*Heterakis putaustralis* Lane, 1914; *Heterakis neoplastica* Wassink, 1917; *Heterakis hastata* Chandler, 1926; *Heterakis lanei* Chandler, 1926; *Heterakis variabilis* Chandler, 1926.

Hosts :—This parasite is associated with the disease known as nodular typhlitis in pheasants. It occurs more especially in the ornamental species, such as the golden and Amherst pheasants, which are frequently kept in captivity in Europe and America. In India *H. isolonche* (including its synonyms) has been recorded by Baylis and Daubney, Chandler, and Maplestone from various Galliform birds in the Zoological Gardens, Calcutta. These include the crimson horned pheasant (*Tragopan satyra*), monál (*Lophophorus impejanus*), blood-pheasant (*Ithaginis cruentus*), crested fireback (*Lophura rufa*), peacock-pheasant (*Polyplectron bicalcaratum*), kaliij (*Gennæus*

* Maplestone (1932, a) considers *H. hastata* and *H. lanei* synonyms of *H. isolonche*, but *H. variabilis* a distinct species. The writer is unable to find in the description of *H. variabilis* sufficient grounds for separating it from *H. isolonche*, and agrees with Maplestone as to the other two species. On the other hand, Maplestone treats *H. beramporia* (vide infra) as a synonym of *H. putaustralis*, which he considers a good species. With this the writer is unable to agree. Some of Maplestone's quotations of measurements from Lane's description of *H. beramporia* are quite erroneous. The writer has re-examined the type-specimens of *H. beramporia* and *H. putaustralis*, which are in the British Museum (Natural History), and also, through the kindness of Col. Clayton Lane, has been able to examine all the other material, in his private collection, identified by him as belonging to these two species. As a result of this study the writer has come to the following conclusions: (1) *H. beramporia* is quite distinct from *H. putaustralis*, and was quite accurately described by Lane; (2) *H. putaustralis* Lane is indistinguishable from *H. isolonche*, and the measurements of its spicules given in the original description do not agree with any of the material examined; (3) the *H. putaustralis* of Maplestone is probably *H. beramporia*.

leucomelanos) and silver pheasant (*Gennæus nycthemerus*). The worms inhabit the cæca of their hosts, the immature forms being found in the thickness of the cæcal walls, frequently in nodular thickenings, while the adults are found free in the lumen.

The measurements of this species are very variable, and this fact probably accounts for its having been described under so many names. The male measures 7–15 mm. in

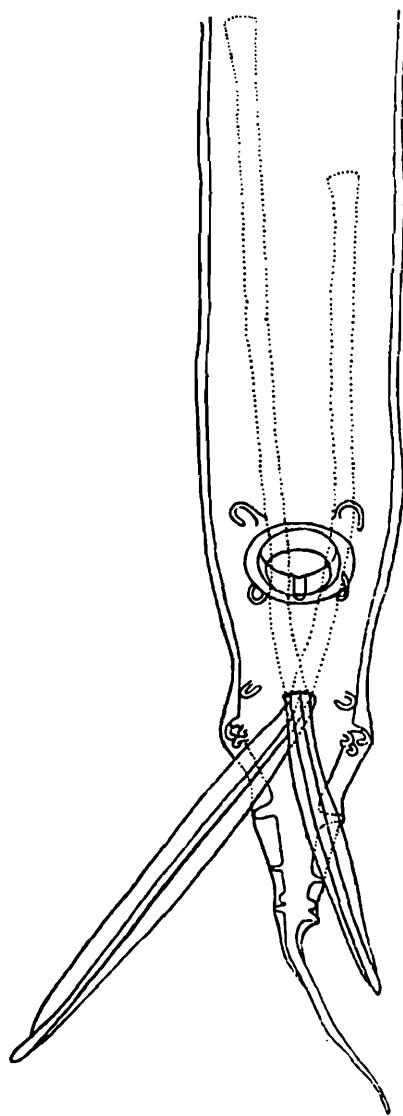

Fig. 55.—*Heterakis isolonche*. Posterior end of male; ventral view.
(After Lucet and Henry.)

length and about 0.25–0.55 mm. in maximum thickness, the female 7.3–17 mm. and about 0.35–0.6 mm. respectively. The cuticular striations are at intervals of about 3μ . Narrow lateral alæ begin at about 0.1 mm. from the anterior end and extend for the greater part of the length of the body. The œsophagus, including the bulb, is about 0.91–2.1 mm. long. The bulb measures about 0.24–0.45 mm. in length and 0.16–0.3 mm. in width. The nerve-ring is situated at about 0.27 mm.,

the excretory pore at 0.38 mm., and the cervical papillæ at 0.5 mm., from the anterior extremity.

The tail of the male is 0.4–0.8 mm. long. The sucker has a diameter of about 0.08–0.15 mm., and is situated at a distance of 0.6–1.06 mm. from the tip of the tail. The twelve pairs of caudal papillæ are arranged as in *H. gallinæ*. The spicules are broadly alate and subequal, the right being slightly longer than the left and having a thicker shaft and broader alæ. The left spicule varies in length from about 0.72 to 1.9 mm., the right from about 1 to 2.3 mm.

The tail of the female measures 0.83–1.75 mm. in length, and is tapering and pointed. The vulva varies somewhat in position, but is usually a little in front of the middle of the body. One or more papilliform tubercles may often be observed in its vicinity. These correspond in diameter with the interior of the sucker of the male, and are probably caused by it. The eggs measure 0.065–0.08 × 0.035–0.046 mm.

9. *Heterakis papillosa* (Bloch, 1782) Railliet, 1885.

Synonyms:—*Ascaris papillosa* Bloch, 1782 (part); *Fusaria papillosa* Zeder, 1803 (part); *Heterakis monticelliana* Stossich, 1892; *Heterakis caudata* v. Linstow, 1906; *Heterakis stylosa* v. Linstow, 1907. (Not *Heterakis papillosa* auctt. = *H. gallinæ*.)

Hosts:—This species is recorded from the cæca and large intestine of bustards (*Otis tarda*, *Tetrax tetrax*) in Europe and Asia by Bloch, v. Linstow and other authors. Maplestone (1932, a) records it from the silver pheasant (*Euplocamus nycthemerus*) and cereopsis goose (*Cereopsis novæ-hollandiæ*) in the Zoological Gardens, Calcutta. The specimens from the goose are recorded under the name of *H. caudata*, but Maplestone states that he believes this to be a synonym of *H. papillosa*. *H. caudata* was originally recorded by v. Linstow from a duck (*Lampronessa [Aix] sponsa*) in Europe. The following description includes the measurements given for both forms.

The male measures 7.3–13 mm. in length, the female 8.9–20 mm. The maximum thickness is 0.22–0.63 mm. Narrow lateral alæ (broader in the œsophageal region) extend throughout almost the whole length of the body. The œsophagus occupies 1/9 to 1/7 of the total length. According to Maplestone it is 1.12–1.56 mm. long, and its bulb has a diameter of 0.18–0.25 mm.

The tail of the male has broad alæ and a long terminal filament. The sucker is of a very characteristic shape, being unusually deep and having a broad base and a narrow opening. Its diameter is about 0.11–0.22 mm., and its distance from the cloaca 0.18–0.3 mm. There are usually twelve pairs of papillæ, whose arrangement is typical except that the lateral

paracloacal papillæ are unusually widely separated. Maplestone observed one specimen in which there was an extra pair of small papillæ at the bases of the intermediate pair. The spicules are equal and measure 0.39–0.61 mm. in length.

The tail of the female occupies 1/15 to 1/9 of the total length, or, according to Maplestone, measures 0.79–1.36 mm., and is finely pointed. The vulva is somewhat variable in position, but is usually situated towards the posterior third of the body. Cuticular tubercles, corresponding in shape with the peculiar sucker of the male, may be present in its vicinity. The eggs measure 0.068–0.075 × 0.042–0.048 mm.

10. *Heterakis beramporia* Lane, 1914.

Synonym * :—*Heterakis putaustralis* of Maplestone, 1932.

Hosts :—This species was originally recorded by Lane from the domestic fowl at Berhampore, Bengal. It has been recorded from the same host in Calcutta by Maplestone, and in the Philippines. The writer has also met with it in material from Malaya. Maplestone further records it from the silver pheasant (*Gennæus nycthemerus*) and Sonnerat's jungle-fowl (*Gallus sonneratii*) in the Zoological Gardens, Calcutta.

The male measures about 5–6 mm. in length and up to 0.26 mm. in maximum thickness, the female about 6–8 mm. and up to 0.3 mm. respectively. In the female the body curves ventrally somewhat abruptly at about the level of the vulva. The cuticular striations are at intervals of about 2 μ . Lateral alæ are present, beginning at about 0.8 mm. from the anterior end and extending in the male to about the level of the sucker, and in the female almost to the tip of the tail. The œsophagus is about 0.75 mm. long, the pharynx occupying 0.045 mm. and the bulb 0.2 mm. The nerve-ring is situated at 0.225 mm., the excretory pore at 0.35 mm., and the cervical papillæ at 0.38 mm., from the anterior extremity.

The tail of the male is 0.37 mm. long. The sucker has a diameter of 0.055 mm., and is situated at a distance of 0.12 mm. from the cloacal opening. There are twelve pairs of papillæ, arranged as in *H. gallinæ*. The spicules are almost equal in length but of different shapes. The left spicule is about 0.3 mm. long, expanded in its distal third, and bears near the tip a rather prominent angle on its ventral surface. The right spicule is about 0.35 mm. long, and has a tapering point with a slight ventral curve.

* See discussion under *H. isolonche* (p. 119, footnote).

The tail of the female is 0.66 mm. long and bears a pair of papillæ at 0.33 mm. from the tip. The vulva is at about the middle of the body and is sometimes covered by a flap which projects from its anterior or posterior lip. The eggs measure 0.05–0.066 × 0.03–0.038 mm.

11. *Heterakis hamulus* v. Linstow, 1906.

Host :—This species was recorded by v. Linstow from the cæca of a species of peafowl (*Pavo muticus* [*P. spiciferus*]) which occurs in the Malay region and Burma. The specimens described were in the Zoological Museum, Königsberg, Germany. The worm does not appear actually to have been found in the Indian region.

According to the brief description given by v. Linstow, the male is 7.5 mm. long and 0.41 mm. in thickness, the female 7.6 mm. and 0.46 mm. respectively. The cuticle is finely striated. The œsophagus occupies 1/9 to 1/8 of the total length.

The tail of the male measures 1/21 of the total length. The preanal sucker has a diameter of 0.071 mm. There are two pairs of pedunculate papillæ at the sides of the sucker, five pairs in the neighbourhood of the cloaca, the most posterior of these being ventral, the others lateral, and three pairs situated more posteriorly. The right spicule is slender and 0.37 mm. long, and is curved into a hook at the tip. The left spicule is straight, 0.32 mm. long, and alate except at the tip. (According to the description it is surrounded by a chitinous sheath from which only the tip projects).

The tail of the female measures 1/8 of the total length. The vulva is situated at about the middle of the body. The eggs measure 0.057 × 0.042 mm.

12. *Heterakis spumosa* Schneider, 1866. (Fig. 56.)

Synonyms :—*Heterakis dahomensis* Gendre, 1911; *Ganguleterakis gangula* Lane, 1914; *Ganguleterakis spumosa* Lane, 1917.

Hosts :—This species occurs in the cæcum of rats of various species, and is widely distributed in many parts of the world. In India it has been recorded from the brown rat (*Rattus norvegicus* [*Mus decumanus*]) at Berhampore, Bengal (Lane).

The male measures 6.4–9.85 mm. in length and 0.26–0.33 mm. in maximum thickness, the female 7–13 mm. and 0.3–0.52 mm. respectively. The cuticular striations are about 10 μ apart. Lateral alæ are present, beginning at about 0.2 mm. from the anterior end and extending in the male to the level of the preanal sucker, in the female to the tip of the tail. In the cervical region the alæ are comparatively wide

(0.07 mm.), but at about the posterior end of the œsophagus they become narrow. The diameter of the head is about 0.07–0.08 mm. The œsophagus, including the bulb, is 0.875–1 mm. long, the pharynx occupying 0.065–0.075 mm. and the bulb 0.25–0.3 mm. The latter is 0.125–0.2 mm. wide. The nerve-ring is situated at 0.33 mm., the excretory pore at about 0.45 mm., and the cervical papillæ at 0.225–0.5 mm., from the anterior end.

The tail of the male is 0.25–0.3 mm. long. The caudal alæ are wide anteriorly, but diminish rather suddenly in width at about the middle of the tail. The preanal sucker is prominent, and has an antero-posterior diameter of 0.065–0.082 mm. Its transverse diameter is greater (0.086–0.1 mm.). The sucker is situated at 0.435–0.6 mm. from the tip of the tail and about

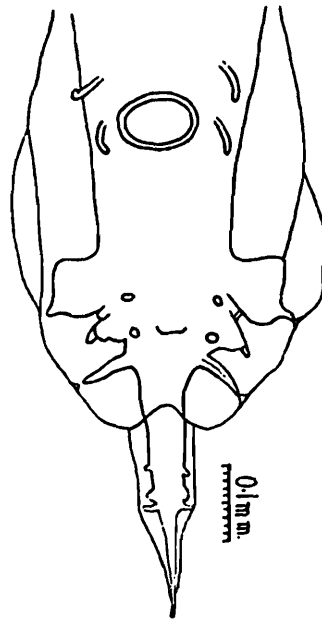

Fig. 56.—*Heterakis spumosa*. Posterior end of male; ventral view. (After Lane.)

0.2 mm. from the cloacal aperture. There are ten pairs of caudal papillæ. The “paracloacal” group includes five pairs, of which three are lateral and two subventral. Of the lateral papillæ the anterior on each side is very large, with a stout, granular base. The next is smaller, but also has a thickened base, while the posterior is long but comparatively slender. The posterior group, situated on the more slender portion of the tail, consists of three pairs, of which the anterior papilla on each side is the most slender and the middle papilla the stoutest. The spicules are subequal and measure 0.2–0.37 mm. (or, according to Gendre, 0.4 mm.) in length. They are flattened, gradually tapering and longitudinally striated.

The tail of the female is 0.68–0.9 mm. long, and bears a pair of papillæ at about 0.45 mm. from the tip. The vulva

is situated slightly behind the middle of the body and has rather prominent lips, each of which bears a pair of papillæ. Cuticular protuberances may be present in its vicinity. The eggs have mammillated shells measuring $0.055-0.065 \times 0.04-0.055$ mm.

13. *Heterakis girardi* (Lane, 1917).

Synonym :—*Gireterakis girardi* Lane, 1917.

Host :—Porcupine (*Hystrix bengalensis*) (intestine); Zoological Gardens, Calcutta.

The male measures 18–21 mm. in length, the female 24–26 mm. In both sexes the maximum thickness is 0.9 mm. The anterior end of the body is curved ventrally. The cuticular striations are 13μ apart. The lateral alæ begin near the anterior end, and are at first narrow. They expand rather suddenly at about the level of the nerve-ring, and reach their maximum width of 0.037 mm. at the level of the oesophageal bulb. From this point they diminish gradually in width, and extend in the male to a point just behind the beginning of the caudal alæ, and in the female to the tip of the tail. The oesophagus is about 2.1 mm. long, the pharynx occupying 0.125 mm. and the bulb 0.6 mm. The latter is 0.35 mm. wide. The cervical papillæ are situated at 0.25 mm. and the excretory pore at 0.6 mm. from the anterior end. The nerve-ring is a little in front of the excretory pore.

The tail of the male is 0.66 mm. long. The caudal alæ, which are joined by a continuous membrane across the ventral surface anteriorly, begin at about 1.35 mm. from the posterior end, and continue nearly to the tip of the tail. The preanal sucker is oval, its longer axis (0.11 mm.) being antero-posterior. Its transverse diameter is 0.1 mm. It is situated at 0.175 mm. from the cloacal aperture. There are 15 pairs of caudal papillæ, of which four are lateral, ten subventral and one subdorsal. The subdorsal pair is the fourth from the posterior end. The largest papillæ are a lateral pair at the level of the cloacal opening. The spicules are equal or subequal, measuring about 1.5 mm. in length. At 0.5 mm. from their roots they are bent ventrally at an obtuse angle. At this point begins an expansion on the inner side of each spicule which extends, with a gradually diminishing width, to within some little distance of the tip of the spicule. The terminal portion of the spicules is rod-like.

The tail of the female is tapering and slightly curved dorsally. It measures 1.9 mm. in length and bears a pair of papillæ at 0.8 mm. from the tip. The vulva is situated at 7–8 mm. from the anterior end of the body. The vagina runs posteriorly

from the vulva for a distance of about 2 mm., where it expands in diameter. At about 6 mm. from the vulva the apparently opposed uterine branches originate. The eggs measure 0.05×0.037 mm.

14. *Heterakis govindi* (Karve, 1930). (Fig. 57.)

Synonym :—*Meteterakis govindi* Karve, 1930.

Host :—*Bufo melanostictus* (rectum); Rangoon, Burma.

The male measures 5–5.4 mm. in length and about 0.23–0.29 mm. in maximum thickness, the female 4.6–6 mm. and 0.25–0.3 mm. respectively. The body is “bent ventrally to a marked degree in both sexes.” Lateral alæ are present, but feebly developed. In the female they begin at about 0.3 mm. from the anterior end and extend to the tip of the

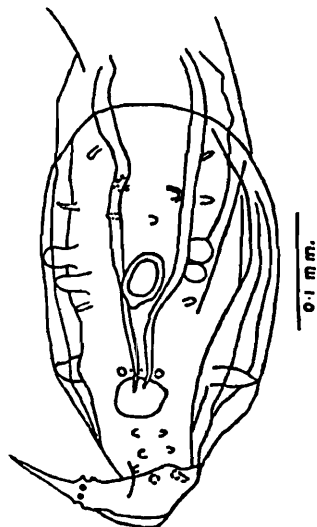

Fig. 57.—*Heterakis govindi*. Posterior end of male; ventral view. (After Karve.)

tail. The œsophagus is about 0.9–1 mm. long, the pharynx occupying 0.043–0.054 mm. and the bulb 0.19–0.3 mm. The latter is 0.143–0.193 mm. wide. Cervical papillæ were not observed. The nerve-ring is situated at about 0.3 mm. and the excretory pore at about 0.46–0.54 mm. from the anterior extremity.

The tail of the male is about 0.17–0.2 mm. long. The cloacal aperture has large and protruding lips. There are well-developed caudal alæ. The preanal sucker measures about $0.041\text{--}0.044 \times 0.024\text{--}0.03$ mm., its longer diameter being antero-posterior. It is situated at about 0.07 mm. from the cloacal aperture. There are at least 17 pairs of caudal papillæ. Four pairs of small, subventral papillæ are situated in front of the sucker. At the sides of the sucker there are three pairs, the two anterior pairs being large, the posterior

pair small. At the sides of the cloacal aperture, or just anteriorly to it, there is a pair of large, lateral papillæ, and also just in front of it there are two pairs of small, subventral papillæ which form a transverse row, those of the inner pair being very minute. Seven more pairs of small papillæ, mostly subventral, are situated on the tail. In addition to the papillæ already mentioned, "the area surrounding the cloacal aperture appears to be covered with minute papillæ." The spicules are equal and similar, tapering and very delicate distally. They measure about 0.27 mm. in length.

The tail of the female is 0.26–0.34 mm. long, tapering and pointed. There is a pair of caudal papillæ at 0.09 mm. from the tip. The vulva is situated a little in front of the middle of the body (at 2.2–2.8 mm. from the anterior end), and is covered by a posteriorly-directed flap. The vagina runs posteriorly from the vulva for a distance of about 1.3 mm., and here gives origin to the two uterine branches. These appear to be parallel. The coils of the ovarian tubes extend anteriorly to a point about 0.34 mm. from the posterior end of the œsophagus, and posteriorly to within about 0.67 mm. of the posterior extremity. The eggs measure 0.075 × 0.043 mm.

2. Genus **PSEUDASPIDODERA** Baylis and Daubney, 1922.

Lips with "cordons," opening in pairs at the interlabial spaces, diverging and sometimes recurrent, ending blindly on the outer surfaces of the lips. Œsophagus as in *Heterakis*, with a short pharynx and a well-developed posterior pyriform bulb. Caudal alæ of male well developed and supported by pedunculate papillæ. Spicules unequal and dissimilar, the right long, the left short and sometimes having a barbed tip. No accessory piece. As in *Heterakis*, papilliform cuticular protuberances are sometimes seen in the neighbourhood of the vulva. These are probably produced by the sucker of the male. Uterine branches opposed. Eggs thin-shelled, with a slight internal thickening at one pole. Adult worms in the large intestine and cæca of Galliform birds.

Genotype :—*Pseudaspidoëra pavonis* Baylis and Daubney, 1922.

Key to Species.

- | | |
|--|-----------------------------|
| Longer spicule of male more than 2 mm. long | <i>voluptuosa</i> , p. 131. |
| Longer spicule of male less than 1 mm. long | 1. |
| 1. Longer spicule about 0.8 mm. long; shorter spicule 0.45 mm. | <i>pavonis</i> , p. 128. |
| Longer spicule less than 0.7 mm. long; shorter spicule about 0.3 mm. | <i>spinosa</i> , p. 132. |

1. *Pseudaspidodera pavonis* Baylis and Daubney, 1922.
(Figs. 58–60.)

Hosts :—Burmese peafowl (*Pavo muticus*), peafowl (*Pavo cristatus*) and argus pheasant (*Argusianus argus*); Zoological Gardens, Calcutta.

The male measures about 6 mm. in length and 0.25 mm. in maximum thickness, the female 7 mm. and 0.3 mm. respectively. The cuticular striations, if present, are extremely fine. The “cordons” on the head consist of tubular grooves running below the surface of the cuticle and having a narrow external

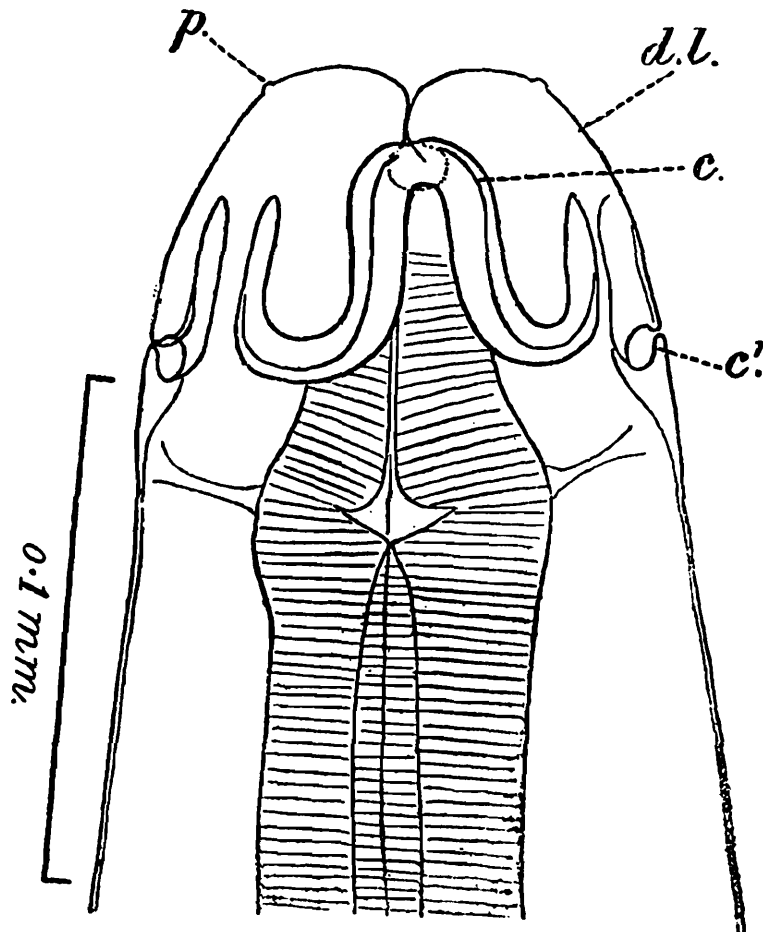

Fig. 58.—*Pseudaspidodera pavonis*. Anterior end of female; lateral view. *c.*, *c'*., cordons; *d.l.*, dorsal lip; *p.*, papilla. (After Baylis and Daubney.)

opening along their length. The members of each pair of “cordons” diverge at once and, after running back for a short distance, turn forward, each on to the outer surface of one of the lips, where it ends separately. The diameter of the head at the posterior limit of the “cordons” is about 0.1 mm. Narrow lateral alæ are present, running down the body from a little in front of the nerve-ring nearly as far as the tail. The œsophagus measures 1.4–1.48 mm. in length in the male, 1.5–1.6 mm. in the female. The bulb is 0.25–0.26 mm. long and 0.17–0.19 mm. wide. The nerve-ring is situated at 0.4–

0.46 mm. and the excretory pore at 0.6–0.65 mm. from the anterior extremity.

The tail of the male is 0.38–0.43 mm. long. The caudal alæ are wide and extend posteriorly nearly to the middle of the tail. The distal portion of the tail is simple and slender, ending in a fine, tapering point. The preanal sucker has

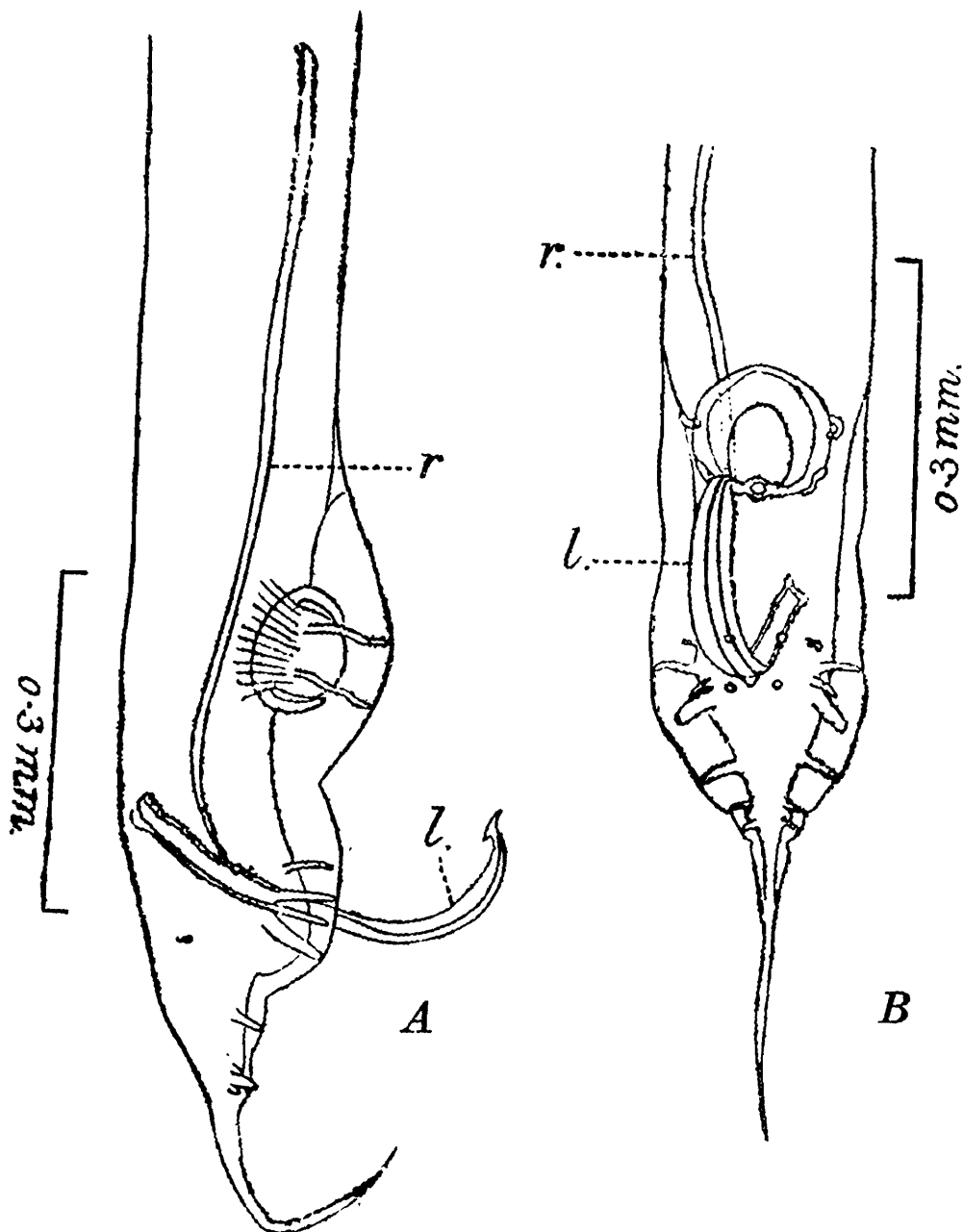

Fig. 59.—*Pseudaspidodera pavonis*. A, posterior end of male, lateral view; B, the same, ventral view. *l.*, left spicule; *r.*, right spicule. (After Baylis and Daubney.)

a diameter of 0.12–0.13 mm., and is situated at 0.15–0.17 mm. from the cloacal aperture. There are twelve pairs of caudal papillæ, arranged as in typical species of *Heterakis*, two pairs being situated at the sides of the sucker, six pairs (four lateral,

two subventral) forming a "paracloacal" group, and three pairs forming a group near the posterior limit of the alæ, with a rather large, isolated pair between this and the paracloacal group. The spicules are very unequal and dissimilar. The right spicule is slender and simple, and measures 0.78 mm. in length. The left spicule is provided with broad alæ, has a barbed tip and is 0.45 mm. long.

The tail of the female is tapering and measures about 1 mm. in length. At about the middle of its length it bears a pair of very minute papillæ. The vulva is situated behind the middle of the body, at about 3 mm. from the posterior end. The vagina runs forward at first for a short distance from the vulva, then, taking a characteristic turn to the right and dorsally, doubles back and runs quite straight posteriorly to a point about 0.8 mm. behind the vulva. Here it doubles

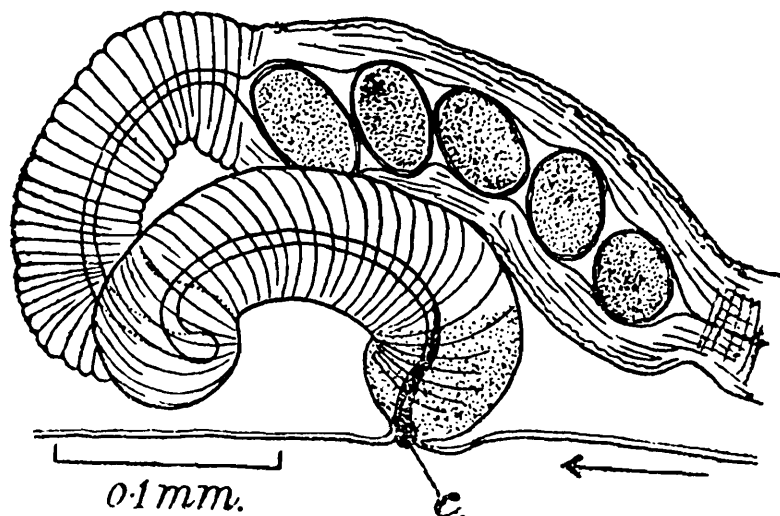

Fig. 60.—*Pseudaspidohera pavonis*. Vulva and vagina; lateral view. c., plug of cement in vulva. The arrow points in the direction of the head. (After Baylis and Daubney.)

forward again, and at about 0.15 mm. behind the vulva gives off the two opposed uterine branches. As in *Heterakis*, the two oviducts, doubling upon themselves in the anterior and posterior halves of the body respectively, return and cross each other, so that the coils of the ovary belonging to the anterior uterus are disposed in the posterior half of the body and those of the other ovary in the anterior half. The eggs are somewhat oblong, with a thin shell measuring about 0.07×0.04 mm., and usually showing a slight internal thickening at one pole. One end of the shell, as seen *in utero*, is occasionally drawn out almost to a point. The contents of the eggs are unsegmented at the time of laying.

2. *Pseudaspidodera voluptuosa* Chandler, 1926.

Synonyms :—*Pseudaspidodera voluptuosus* Chandler, 1926 ; *Heterakis longespiculum* Maplestone, 1931.

Hosts :—Argus pheasant (*Argusianus argus*) and red-crested wood-quail (*Rollulus rouloul*) (large intestine and cæca); Zoological Gardens, Calcutta.

The male measures 6.25–9.25 mm. in length and 0.325–0.38 mm. in maximum thickness, the female 9.35–10.15 mm. and 0.46 mm. respectively. The cuticle is very finely striated. The cephalic “cordons” are not recurrent, but each is curved so as to form a quarter of a circle, its tip nearly meeting one of the cordons of the adjacent pair. The lateral alæ are about 25 μ wide. They begin at about 0.15 mm. from the anterior end, and extend for about 3/5 of the length of the body in the female and 3/4 of its length in the male. The œsophagus is about 1.3 mm. long in the male, 1.6–1.7 mm. in the female. The pharynx is about 0.09 mm. long and the bulb 0.3–0.32 mm. The latter is 0.25 mm. wide. The nerve-ring is situated at about the middle of the prebulbar portion of the œsophagus.

The tail of the male is 0.36–0.39 mm. long. The caudal alæ and papillæ are similar to those of *P. pavonis*. The pre-anal sucker has a diameter of about 0.1 mm., and is situated at 0.125–0.16 mm. from the cloacal aperture. The spicules are very long and unequal in length. The left spicule, according to Chandler, is the longer, and measures 2.7–3.45 mm., while the right measures 1.44–1.7 mm. The right spicule has broad alæ for its whole length and a simple, pointed tip. The left spicule has narrower alæ and tapers more gradually to the tip.

The tail of the female is slender and tapering, and measures 1.05–1.25 mm. in length. The vulva is situated considerably behind the middle of the body, dividing the total length in the proportion of about 6:4. The body is very slightly narrowed immediately behind the vulva. A number of cuticular protuberances, probably caused by the sucker of the male, may be present in the vicinity of the vulva, usually a short distance behind it. The vagina turns forward from the vulva for some distance. The eggs are oblong and thin-shelled, and measure 0.06–0.068 \times 0.035–0.038 mm.

Chandler (1926, *a*) has described a variety (var. *minor*) of this species from the red-crested wood-quail (*Rollulus rouloul*). It differs from the typical form only in size and in a few minor characters. The male measures 5–5.5 mm. in length and 0.225–0.25 mm. in maximum thickness, the female 6.75–7.85 mm. and 0.31 mm. respectively. The œsophagus is

relatively a little longer than in the typical form, occupying about one-fifth of the total length. The tail of the male is relatively longer, reaching a length of 0.36–0.4 mm. This is due to the greater length of the slender posterior portion. “The bursa and papillæ are similar to those of the typical form except for a slightly better development of the third paracloacals. The spicules are not reduced in size as is the body.” The right spicule is about 1.5 mm. long and the left 3–3.4 mm., or $\frac{3}{5}$ to $\frac{5}{8}$ of the total length. The tail of the female is about 1 mm. long. “The vulva is situated a little farther forwards than in the typical form and divides the body about 6 : 5 or even more nearly into equal halves.”

Maplestone (1932, *a*) states that on re-examination of his species *Heterakis longespiculum* he has concluded that it is identical with *P. voluptuosa* var. *minor*, the cephalic “cordons” having been so indistinct in the original material as to escape his notice. Some of the measurements given by Maplestone (1931) for *H. longespiculum* are rather different from Chandler’s. He gives the length of the tail of the male as 0.455 mm., and of that of the female as 1.5 mm. The lengths of the spicules are given as 2.08 mm. and 4.1 mm.

3. *Pseudaspidodera spinosa* Maplestone, 1932.

Host:—Argus pheasant (*Argusianus argus*) (intestine); Zoological Gardens, Calcutta.

The male measures 7.8–8.5 mm. in length, the female about 9.3–9.5 mm. The maximum thickness is 0.45–0.49 mm. The cordons are well developed and are “armed for their whole length by a single row of relatively stout spines.” They extend back on the dorsal surface for a distance of 0.2–0.24 mm., and on the subventral surfaces for 0.22–0.27 mm. Their recurrent branches anastomose at about the level of the posterior end of the pharynx. The œsophagus measures 0.65–0.71 mm. in length, of which the pharynx occupies 0.08–0.11 mm. and the bulb 0.32–0.34 mm. The diameter of the bulb is 0.25–0.28 mm.

The tail of the male is 0.39–0.45 mm. long. “The caudal alæ appear to be divided into three portions by one transverse groove between the sucker and cloaca and a second one just behind the posterior group of caudal papillæ.” There are twelve pairs of caudal papillæ, the arrangement of which is typical. The sucker is relatively large, having a diameter of 0.24–0.25 mm., and is situated at a distance of 0.14–0.18 mm. from the cloacal aperture. The spicules are similar in form but unequal in length. They measure respectively 0.277–0.317 mm. and 0.614–0.673 mm.

The tail of the female is 1.09 mm. long. The vulva is situated somewhat behind the middle of the body, at 3.745–4.058 mm. from the posterior end. The vagina is similar to that of *P. pavonis*. The eggs measure 0.06 × 0.036 mm.

3. Genus **ASCARIDIA** Dujardin, 1845.

Lips well developed, without “cordons.” Slight lateral alæ usually present on the body. Œsophagus club-shaped, without posterior bulb. Male with slight caudal alæ and relatively large caudal papillæ. Spicules equal or subequal. No accessory piece. Vulva near the middle of the body. Uterine branches opposed. Eggs thick-shelled, with an appearance as of an internal thickening of the shell at one pole. Adult worms in the small intestine of birds and reptiles.

Genotype :—*Ascaridia hermaphrodita* (Frölich, 1789).

Key to Species.

Parasite of “jungle crow” (<i>Centropus</i>)	<i>trilabium</i> , p. 141.
Parasite of pigeons	<i>columbæ</i> , p. 137.
Parasites of Galliform birds.	1.
Parasites of cranes	2.
1. Third pair of caudal papillæ of male from anterior end subventral	<i>galli</i> , p. 133.
Third pair of caudal papillæ of male from anterior end lateral	<i>compar</i> , p. 136.
2. Male with six pairs of preanal papillæ	<i>cristata</i> , p. 139.
Male with three pairs of preanal papillæ	<i>stroma</i> , p. 140.

1. ***Ascaridia galli*** (Schrank, 1788) Freeborn, 1923. (Fig. 61.)

Synonyms* :—*Ascaris teres* Goeze, 1782 (part); *Ascaris galli* Schrank, 1788; *Ascaris gallopavonis* Gmelin, 1790; *Fusaria inflexa* Zeder, 1800; *Ascaris perspicillum* Rudolphi, 1803; *Ascaris inflexa* Rud., 1809; *Ascaris gibbosa* Rud., 1809; *Ascaris (Ascaridia) perspicillum* Dujardin, 1845; *Ascaris (Ascaridia) inflexa* Duj., 1845; *Ascaris (Ascaridia) gibbosa* Duj., 1845; *Heterakis inflexa* Schneider, 1866; *Heterakis lineata* Schneider, 1866; *Heterakis perspicillum* Railliet, 1893; *Heterakis granulosa* v. Linstow, 1906; *Ascaridia perspicillum* Railliet and Henry, 1912; *Ascaridia lineata* Raill. and Henry, 1912; *Ascaridia granulosa* Raill. and Henry, 1912; *Ascaridia hamia* Lane, 1914.

Hosts :—This species is of cosmopolitan distribution, and occurs in a considerable number of birds—chiefly Galliformes, but also ducks. Its most usual host is the common fowl. It also occurs in the turkey, guineafowl and domestic duck. Hosts from which it has been recorded in India include the common fowl (Berhampore, Bengal (Lane) ; Calcutta (Baylis

* See Baylis, 1932, Ann. & Mag. Nat. Hist. (10) x, pp. 520–524.

and Daubney); Madras (Ackert); Colombo, Ceylon (v. Linstow)) and the blood pheasant (*Ithaginis cruentus*) (Zoological Gardens, Calcutta; Baylis and Daubney). The usual habitat of the adult worms is the lumen of the small intestine of the host. They are, however, sometimes found in the large intestine, and occasionally wander into the oviduct. In the latter case they may become enclosed in an egg at the time of the deposition of the shell. A considerable number of instances are on record of the finding of such worms in eggs.

The male measures 33–80 mm. in length and 0.49–1.21 mm. in maximum thickness, the female 60–123 mm. and 0.9–1.86 mm. respectively. The diameter of the head is 0.28–0.47 mm. The dorsal lip is somewhat broader than the subventral lips, and bears a pair of large, lozenge-shaped papillæ. Each of the subventral lips has one large lozenge-shaped papilla towards its ventral side, and a very small circular papilla, more anteriorly placed, towards the other side. On the inner surface of each lip anteriorly there is a transverse ridge, sometimes described as a dentigerous ridge. It does not, however, appear to bear teeth. A pair of feebly-developed and extremely narrow lateral alæ may sometimes be detected in the cervical region, but alæ are not distinguishable at all as a rule. The interval between the cuticular striations varies from 12.5μ , according to Dujardin, to 100μ , according to Ackert. The œsophagus is 2.1–7.2 mm. long, its average length, according to Ackert, being 3.5 mm. in the male and 3.9 mm. in the female. The nerve-ring is situated at 0.3–1.5 mm., the excretory pore at 0.74–1.53 mm., and the cervical papillæ at about 0.9 mm., from the anterior end. According to Lane there may be five or six small “nuchal” papillæ on each side close to the head. The writer has been unable to verify this, but in certain other species of the genus a considerable series of papillæ certainly occurs in the cervical region.

The tail of the male measures 0.48–0.85 mm. in length. The preanal sucker has a diameter of 0.2–0.28 mm. in mature specimens, though in very young individuals it is sometimes as small as 0.14 mm. It is situated at a distance of 0.2–0.24 mm. from the cloacal aperture. The ventral surface in the neighbourhood of the cloacal aperture, and as far forward as the sucker, is usually covered with small papilliform cuticular bosses. The normal number of caudal papillæ is ten pairs, which are generally arranged as shown in fig. 61. There is, however, a good deal of variation in the position of some of the papillæ, and even in their number. Occasionally one or both of a pair may be absent, two papillæ may be fused, or extra papillæ may be interpolated. The spicules measure 1–2.5 mm. in mature specimens (average length 1.94 mm.,

according to Ackert). In young males they may measure only 0.54 mm.

The tail of the female is about 1–1.88 mm. long (average 1.56 mm., Ackert). There is a pair of papillæ at about 0.5 mm. from the tip. The vulva varies considerably in position, but is usually somewhat in front of the middle of the body. The eggs have smooth, thick shells measuring 0.065–0.088 × 0.04–0.05 mm. (average 0.076 × 0.049 mm., according to Ackert). The thickening sometimes observed on the inside of the shell at one pole does not, according to Ackert, belong to the shell itself, but to the vitelline membrane.

Fig. 62.

Fig. 61.

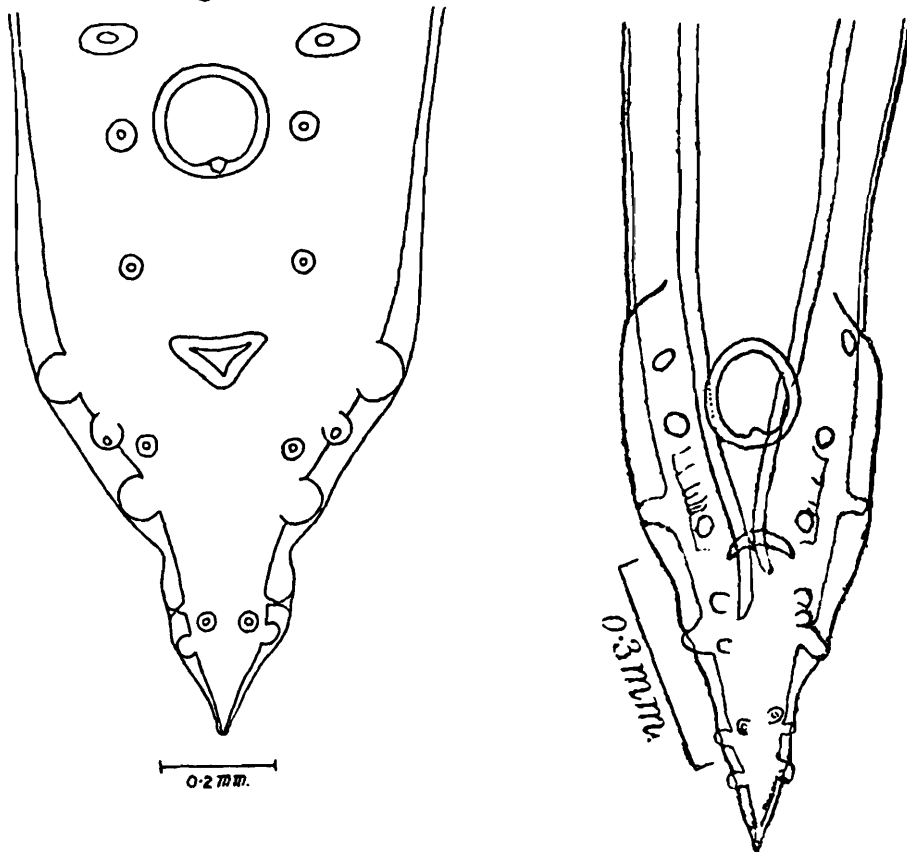

Fig. 61.—*Ascaridia galli*. Posterior end of male; ventral view.
(After Boulenger.)

Fig. 62.—*Ascaridia compar*. Posterior end of male; ventral view.
(After Baylis and Daubney.)

The life-history of this species, which has been extensively studied by Ackert (1931) and others, may be briefly summarized as follows:—The eggs, which are unsegmented when laid, are passed to the exterior in the bird's droppings, and develop to the infective stage in 10 to 16 days or more, according to the conditions of moisture and temperature. If swallowed at this stage by a suitable host they hatch in the duodenum. Experiments have shown that eggs may occasionally hatch

in water, and that infestation may follow the ingestion of the free larvæ. This, however, probably rarely happens in nature, and the swallowing of eggs is regarded as the usual mode of infection. During the first nine days after hatching the larvæ live in the posterior portion of the duodenum, either in the lumen or between the villi of the lining. From about the tenth to the seventeenth day they penetrate the mucous membrane, and may be observed with their anterior ends buried therein and the posterior half of the body projecting into the lumen. From the eighteenth day onwards they withdraw from the mucosa and live free in the lumen. A few larvæ may occasionally migrate into other organs, such as the liver and lungs, but such migration is apparently not a regular feature of the life-history. The worms reach sexual maturity by about the fiftieth day in chickens infected when a month old.

2. *Ascaridia compar* (Schrank, 1790) Travassos, 1913. (Fig. 62.)

Synonyms:—*Ascaris compar* Schrank, 1790; *Ascaris lagopodis* Frölich, 1802; *Fusaria compar* Zeber, 1803; *Ascaris (Ascaridia) compar* Dujardin, 1845; *Heterakis compar* Stossich, 1887.

Hosts:—This species has been recorded from a considerable variety of Galliform birds in Europe, Asia, America and Australia. In India it has been recorded from the chakor (*Alectoris græca chukar*) in the Zoological Gardens, Calcutta (Baylis and Daubney).

The male measures about 36–54 mm. in length and 1.2 mm. in maximum thickness, the female 65–96 mm. and 1.6 mm. respectively. The lips are somewhat trilobed, and each has on its inner surface a prominent cuticular ridge, without teeth, which projects beyond its anterior border. The œsophagus occupies about 1/14 of the total length.

The tail of the male is about 1/66 of the total length, and is provided with alæ of moderate width. According to Müller (1897), the preanal sucker measures 0.34 × 0.3 mm., but his figure does not suggest so large a size, and an error may be suspected in his measurements. In material examined by Baylis and Daubney the sucker was much smaller, having a greater diameter of about 0.15 mm. There are ten pairs of caudal papillæ, arranged as shown in fig. 62. The spicules measure 1.78 mm. in length.

The tail of the female is about 1 mm. long. The eggs measure 0.08–0.091 × 0.057–0.06 mm.

There is very little difference between this species and *A. galli*. As will be seen from the figure, the third pair of caudal papillæ from the anterior end was, in this specimen, distinctly lateral, while in *A. galli* it is subventral. It is not certain whether this character is constant.

3. *Ascaridia columbæ* (Gmelin, 1790) Travassos, 1913.
(Fig. 63.)

Synonyms:—*Ascaris columbæ* Gmelin, 1790; *Ascaris maculosa* Rudolphi, 1802; *Fusaria maculosa* Zeder, 1803; *Ascaris (Ascaridia) maculosa* Dujardin, 1845; *Heterakis maculosa* Schneider, 1866; *Heterakis columbæ* Railliet, 1885; *Ascaridia maculosa* Railliet and Henry, 1912.

Hosts:—This species is of cosmopolitan distribution, and occurs in pigeons of many species, including the domestic varieties. In India it has been recorded from the Bengal green pigeon (*Crocopus phaenicopterus*), *Phlogœnas luzonica* and other pigeons (species unknown) in the Zoological Gardens, Calcutta (Baylis and Daubney).

The male measures 16–70 mm. in length and about 0.7–1.1 mm. in maximum thickness, the female 20–95 mm. and 1.2–2.5 mm. respectively. The head has a diameter of about 0.18–0.23 mm. There are very pronounced cuticular striations on the body, at intervals of about 25 μ . Lateral alæ are present in the cervical region only. There is a series of 26 to 30 pairs of cervical papillæ, extending backwards from near the posterior end of the alæ, the first two or three pairs being situated within the alæ. The nerve-ring is situated at about 0.5 mm. from the anterior end. Numerous rounded or oval vesicular bodies are usually present within the body-cavity, and it is from these that the name *maculosa* originated.

The tail of the male is about 0.48 mm. long. The caudal alæ are slight. The sucker has a diameter of 0.15–0.2 mm., and is situated at a distance of 0.48 mm. from the cloacal aperture. The caudal papillæ are subject to considerable variation in position and in number. Typically there are 14 pairs. Five of these are definitely postanal, the third from the posterior end being subventral, the others lateral. An adanal group consists of four pairs, of which one is large and lateral, the other three smaller and arranged in a triangle on each side. The preanal series includes three pairs of subventral papillæ between the cloaca and the sucker, a pair more laterally placed at about the level of the anterior margin of the sucker, and a pair in front of the sucker. This last pair is sometimes duplicated. The spicules are equal and measure 1.2–1.9 mm. in length.

The tail of the female is conical, with a terminal spike, and measures 1.1–1.2 mm. in length. The vulva is situated at about the middle of the body. The eggs measure 0.06–0.09 \times 0.04–0.05 mm.

The life-history of this species appears to be similar to that described for *A. galli*.

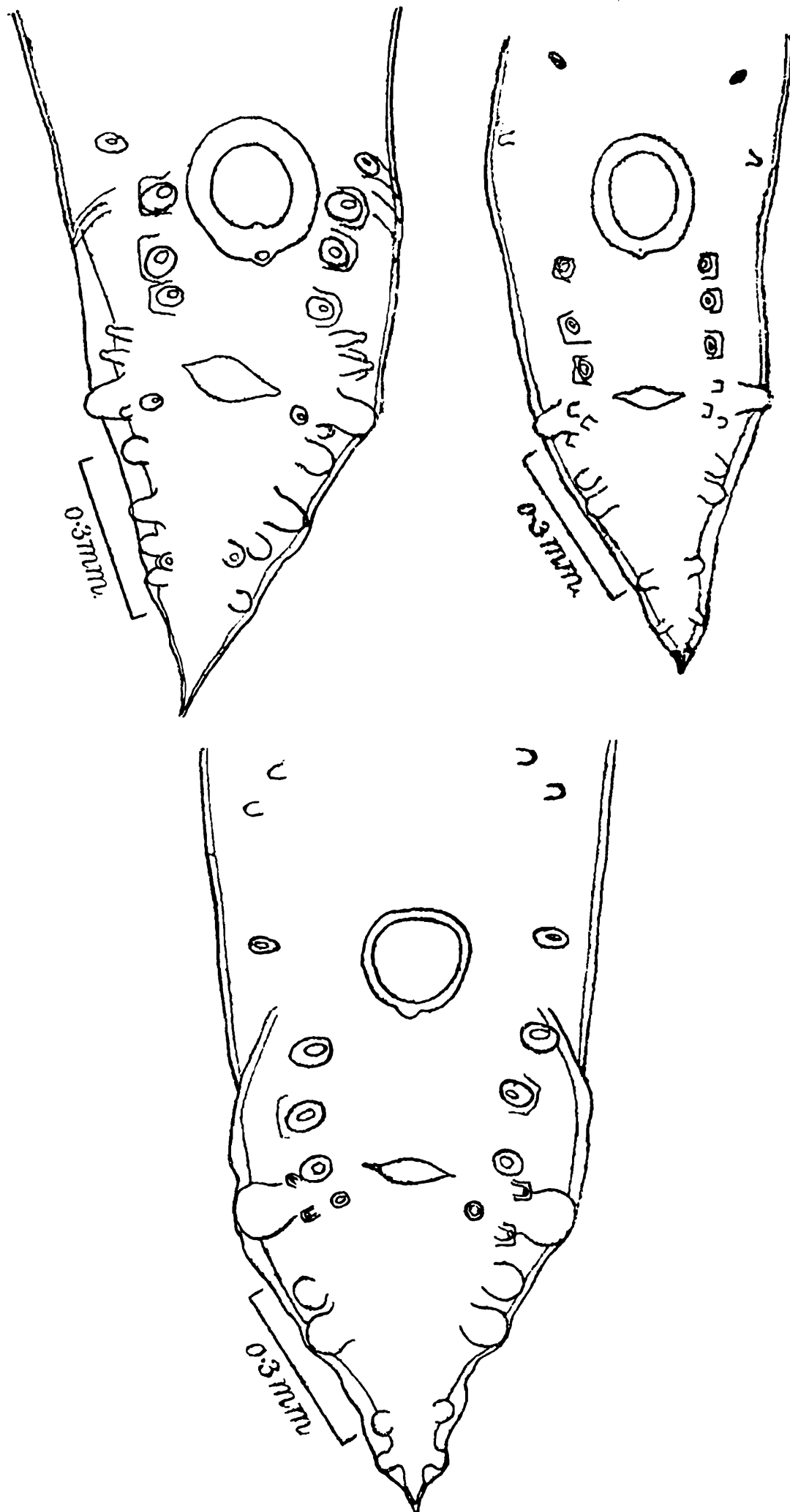

Fig. 63.—*Ascaridia columbæ*. Posterior ends of three males; ventral view, showing variations in papillæ. (After Baylis and Daubney.)

4. *Ascaridia cristata* (v. Linstow, 1901) Railliet and Henry, 1914. (Fig. 64.)

Synonym :—*Heterakis cristata* v. Linstow, 1901.

Hosts :—This species was originally recorded from a crowned crane (*Balearica regulorum*) in East Africa. It has also been recorded from the West African crowned crane (*Balearica*

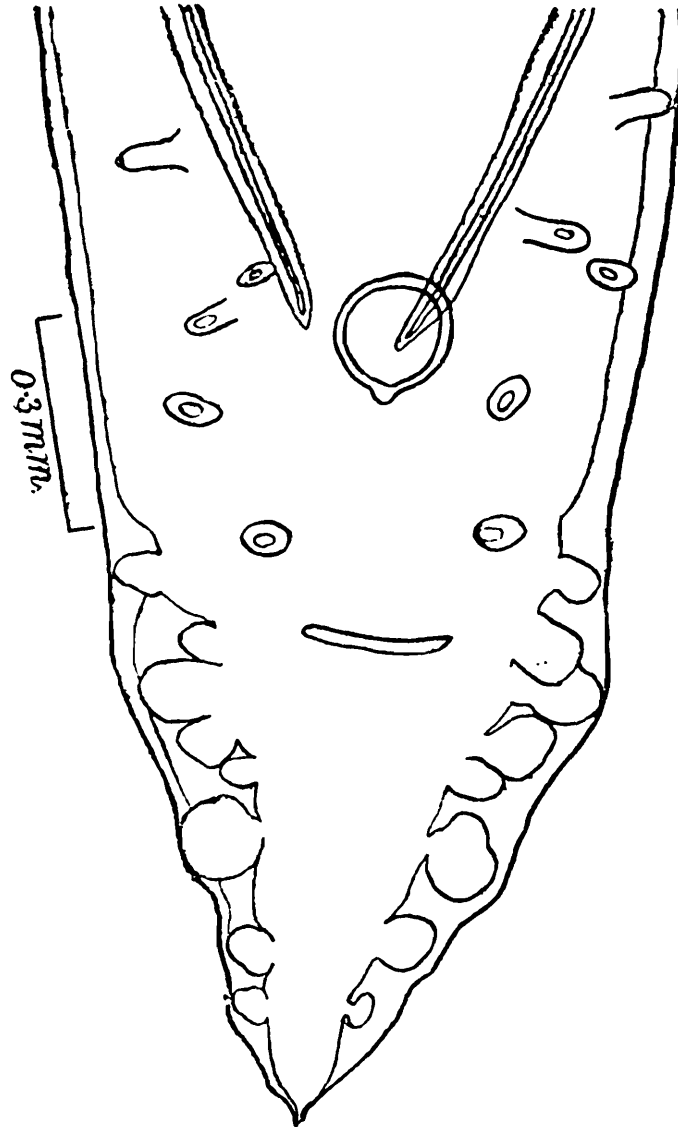

Fig. 64.—*Ascaridia cristata*. Posterior end of male ; ventral view. (After Baylis and Daubney.)

pavonina) and the sarus crane (*Antigone antigone*) in the Zoological Gardens, Calcutta (Baylis and Daubney).

The male measures 35–38 mm. in length and 1.1–1.34 mm. in maximum thickness, the female 38–57 mm. and 1.1–1.76 mm. respectively. The head is 0.27–0.28 mm. in diameter. The dorsal lip is shorter and broader than the ventro-lateral lips. Each of the latter bears, according to v. Linstow, two blunt teeth. The cervical alæ extend back for a distance of

1.22 mm. from the anterior end. There is a series of 27 pairs of cervical papillæ, extending back from a point about 0.9 mm. from the head end for a distance of 6–6.5 mm. The anterior pairs are placed just dorsally to the cervical alæ and the distance between successive pairs varies from 0.15 to 0.3 mm. The œsophagus is 2.1–2.3 mm. long. The nerve-ring is situated at 0.46 mm., and the excretory pore at about 0.7 mm., from the anterior end.

The tail of the male is short and conical. It measures about 0.62 mm. in length. There are 13 pairs of caudal papillæ, of which seven are postanal and six preanal (v. Linstow described and figured only two pairs of preanal papillæ). The spicules are slender and alate, and measure 0.95 mm. in length.

The tail of the female is 0.7 mm. long. The vulva is situated at about 20 mm. from the anterior end in specimens 38–40 mm. in length, and is slightly salient. The eggs measure 0.085–0.091 × 0.058–0.062 mm.

5. *Ascaridia stroma* (v. Linstow, 1899) Railliet and Henry, 1914. (Fig. 65.)

Synonym :—*Heterakis stroma* v. Linstow, 1899.

Hosts :—The host from which this species was originally recorded was *Grus paradisea*. It has also been recorded from

Fig. 65.

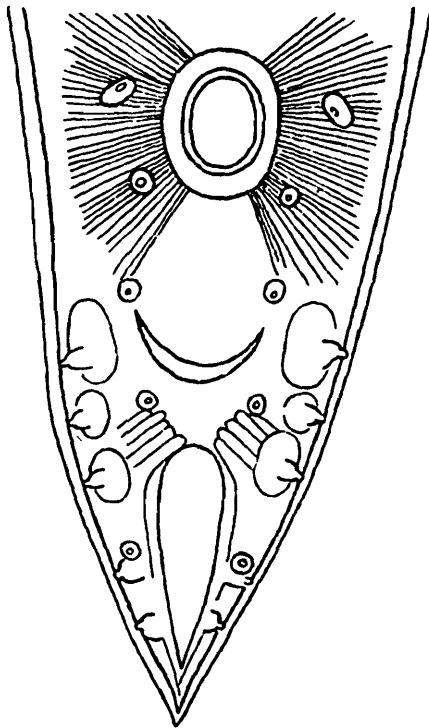

Fig. 66.

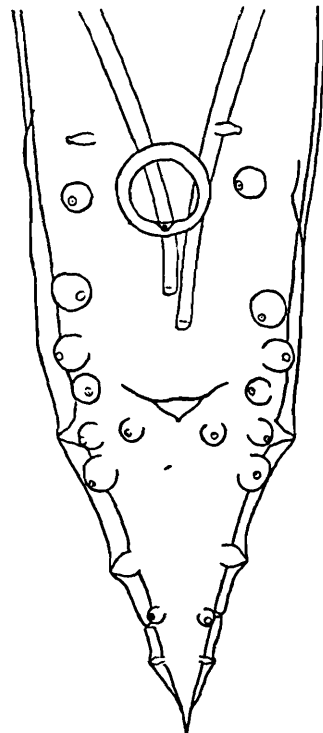

Fig. 65.—*Ascaridia stroma*. Posterior end of male; ventral view. (After v. Linstow.)

Fig. 66.—*Ascaridia trilabium*. Posterior end of male; ventral view. (Original.)

the common crane (*Grus grus*) and the sarus crane (*Antigone antigone*) in the Zoological Gardens, Calcutta (Baylis and Daubney).

The following characters are taken from v. Linstow's description:—The male measures 25 mm. in length and 0.8 mm. in maximum thickness, the female 56 mm. and 1.7 mm. respectively. Broad cervical alæ are present. The œsophagus occupies, in the male, 1/16 of the total length.

The tail of the male is 1/47 of the total length. There are ten pairs of caudal papillæ, of which six are postanal, one adanal and three preanal.

The tail of the female is 1/117 of the total length, and has a digitiform terminal process. The eggs are exceptionally large, measuring 0.172 × 0.146 mm.

6. *Ascaridia trilabium* (v. Linstow, 1904) Railliet and Henry, 1914. (Fig. 66.)

Synonym :—*Heterakis trilabium* v. Linstow, 1904*.

Host :—“ Jungle crow ” (*Centropus sinensis*); Horana, Ceylon.

The writer has been enabled, through the courtesy of the Director of the Colombo Museum, to examine the type-specimens of this species. These consist of one male and two females, besides some fragments. As the writer's measurements and other observations differ considerably from those of v. Linstow, it seems advisable to give a new description of the species.

The male measures 27 mm. in length and about 0.75 mm. in maximum thickness, the females 38–39 mm. and about 0.9 mm. respectively. The diameter of the head is about 0.2–0.25 mm. The cuticular striations are at intervals of about 25 μ . Wide cervical alæ begin immediately behind the lips and extend back to about the middle of the œsophageal region, where they rather suddenly disappear. Their maximum width, in the female, is about 0.1 mm. The œsophagus is 1.95 mm. long in the male, 2.3 mm. in the females. A pair of stout cervical papillæ is situated immediately behind the base of the lips. The nerve-ring is situated at 0.5–0.55 mm., and the excretory pore at 0.6–0.7 mm., from the anterior end.

* It appears possible that *Ascaridia* [*Heterakis*] *circularis* (v. Linstow, 1903), recorded from *Centropus sinensis* in Siam, may be identical with *A. trilabium*, but this question cannot be determined without a re-examination of the type-specimens of *A. circularis*. According to v. Linstow's description this species has only eight pairs of caudal papillæ in the male.

The tail of the male is 0.5 mm. long. The sucker has a diameter of about 0.14 mm., and is situated at about 0.25 mm. from the cloacal aperture. There are thirteen pairs of caudal papillæ, arranged as shown in fig. 66. The spicules are equal and measure about 2.3 mm. in length.

The tail of the female is 0.77 mm. long, and has a pair of papillæ at about 0.25 mm. from the tip. The vulva is situated at about 19 mm. from the posterior end in a specimen 39 mm. long. The eggs measure 0.0825–0.0875 × 0.05–0.055 mm.

4. Genus **STRONGYLURIS** Müller, 1894.

Lateral fields conspicuous, composed of a single row of large cells. Lips well developed, without "cordons," but expanded in front and at the sides into a cuticular flange. Œsophagus with a relatively long pharynx, the lumen of which forms a ventral "kink" at its posterior end, and with a well-developed posterior bulb. Tail of male obliquely truncate ventrally and with a short terminal spike. Caudal alæ well developed and supported by stout, pedunculate papillæ, giving them the appearance of a bursa. Spicules relatively long, equal or subequal. No accessory piece. Uterine branches parallel. The eggs may be segmenting before oviposition. Adult worms in the alimentary canal of lizards and chameleons.

Genotype :—*Strongyluris brevicaudata* Müller, 1894.

Key to Species.

Parasite of chameleon
Parasite of lizard (*Calotes*)

chamæleonis, p. 142.
calotis, p. 145.

1. **Strongyluris chamæleonis** Baylis and Daubney, 1922. (Figs. 67–69.)

Host :—*Chamæleon chamæleon* [*C. vulgaris*]; Zoological Gardens, Calcutta.

The male measures 6.3 mm. in length, the female 8.4–8.75 mm. The maximum thickness is 0.5–0.7 mm. The cuticular striations are exceedingly fine. There are no lateral alæ. The lateral fields are broad, and each consists of a single row of about 70 large, granular cells with clear, rounded nuclei. Cervical papillæ have not been observed, nor do the longitudinal rows of small papillæ on the body, which occur in some species of the genus, appear to be present. The diameter of the head is about 0.06 mm. The Œsophagus is about 1.1 mm. long (including the bulb) in the male, 1.45 mm.

in the female. Of this length the pharynx occupies 0.18–0.22 mm., while the bulb, which is almost spherical, measures 0.2–0.25 mm. in diameter. The nerve-ring is situated at 0.37–0.39 mm., and the excretory pore at 0.6–0.85 mm., from the anterior end.

The tail of the male is about 0.13 mm. long, including a terminal spike measuring 0.06 mm. The caudal alæ form an almost circular bursa-like expansion. The sucker has a diameter of 0.09 mm., and its aperture is directed somewhat

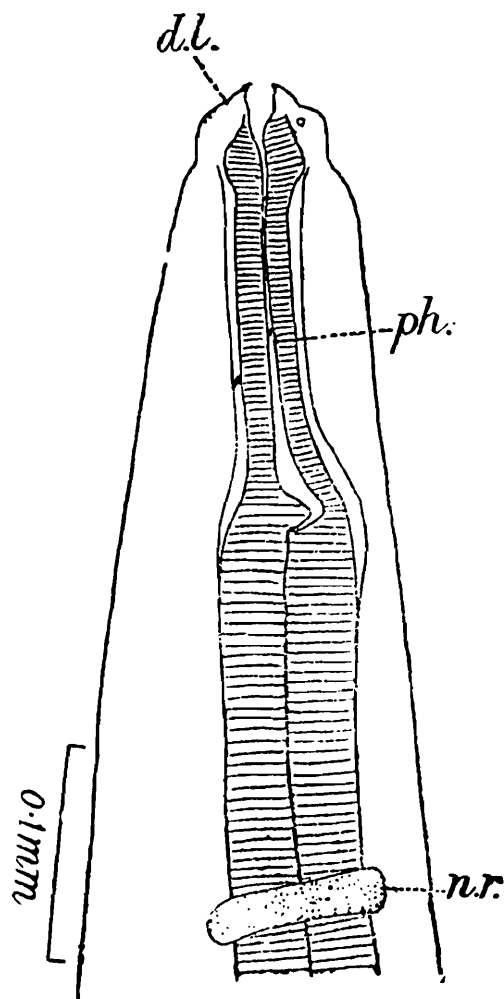

Fig. 67.—*Strongyluris chamæleonis*. Anterior end of female; lateral view. *d.l.*, dorsal lip; *n.r.*, nerve-ring; *ph.*, pharynx. (After Baylis and Daubney.)

posteriorly. There are apparently nine pairs of caudal papillæ, of which seven project more or less laterally into the alæ, while two are situated ventrally behind the cloacal aperture. The spicules are 1.1 mm. long and 0.0275 mm. in maximum thickness, are covered with rather coarse granulations, and taper gradually from their roots to slender points.

The tail of the female is conical and measures 0·3 mm. in length, and bears a pair of small papillæ at 0·14 mm. from the tip. The vulva is situated at 3–3·3 mm. from the posterior end. The vagina is long and narrow, and pursues a rather tortuous course, the general direction of which is posterior from the vulva. The branches of the uterus are parallel, running at first posteriorly to within a short distance of the

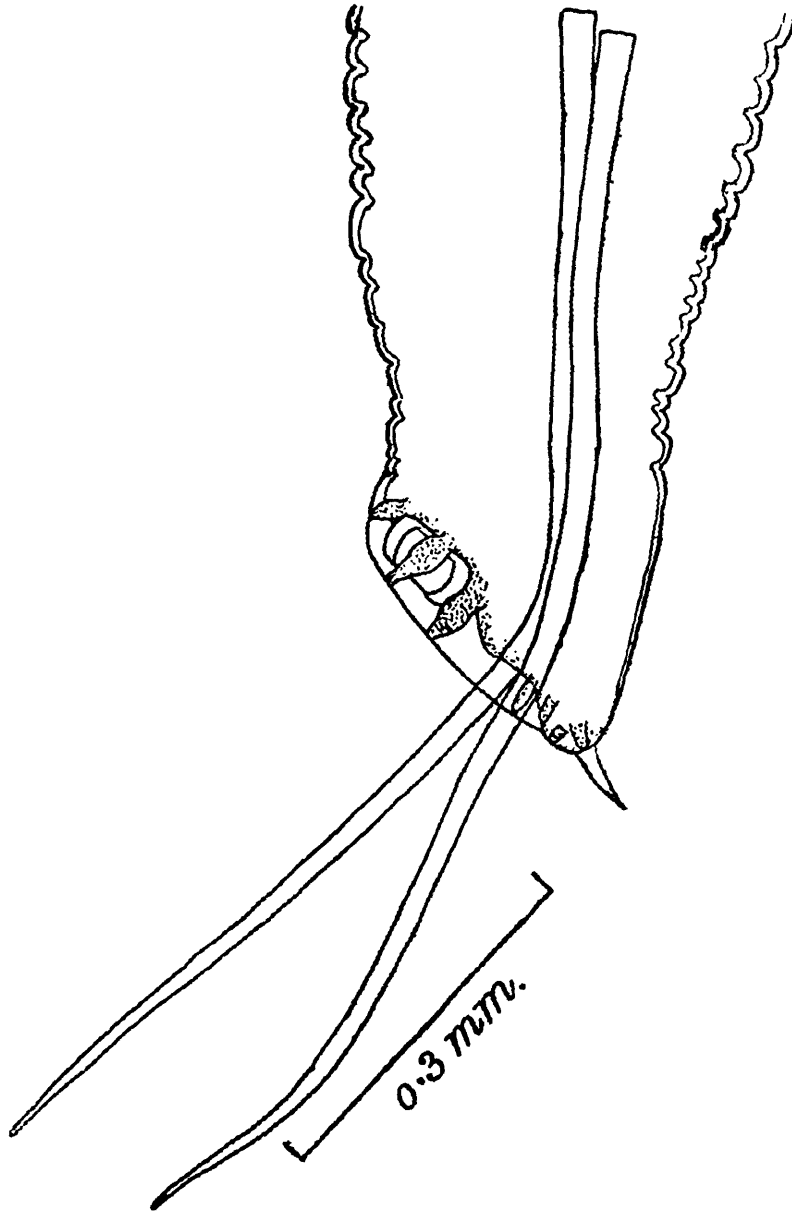

Fig. 68.—*Strongyluris chamæleonis*. Posterior end of male; lateral view. (After Baylis and Daubney.)

anus, then returning towards the anterior end. The coils of the ovaries are situated in the anterior half of the body. The eggs are oval, with a thick shell, slightly flattened externally and thickened internally at each pole. They measure about $0\cdot0875 \times 0\cdot055$ mm., and their contents are unsegmented at the time of laying.

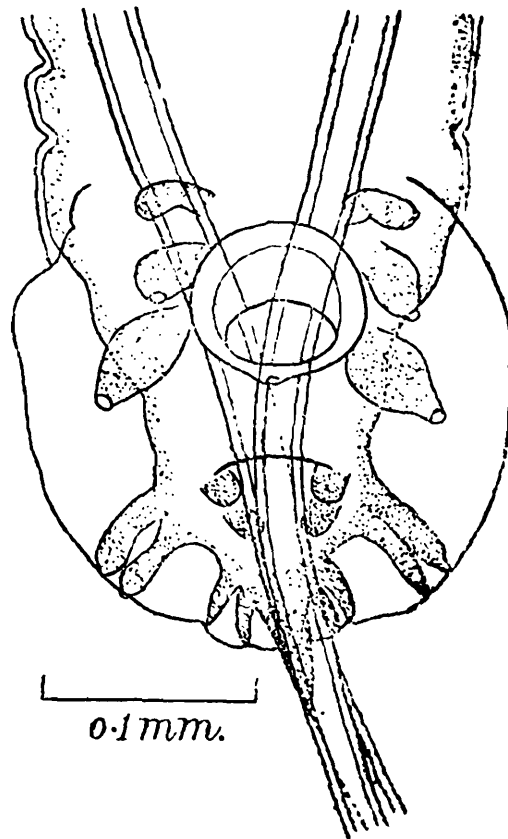

Fig. 69.—*Strongyluris chamæleonis*. Posterior end of male; ventral view. (After Baylis and Daubney.)

2. *Strongyluris calotis* Baylis and Daubney, 1923. (Figs. 70 & 71.)

Host :—*Calotes nigrilabris* (rectum) ; Pattipola, Ceylon.

The male measures 8.9–11.1 mm. in length and 0.4–0.5 mm. in maximum thickness, the female 11–13.65 mm. and 0.55–0.75 mm. respectively. The diameter of the head is 0.06–0.08 mm. Each lip has broad lateral cuticular expansions and a further cuticular flange projecting anteriorly. The dorsal lip carries two large marginal papillæ, each ventro-lateral lip one papilla, situated further from the margin and towards the ventral side. The neck is wider than the head, forming a “shoulder” behind the base of the lips. A second “shoulder” is formed a little further back by the commencement of a cuticular inflation which covers part of the pharyngeal and oesophageal regions. The cuticular striations are extremely fine. No cervical papillæ were observed, nor any rows of papillæ on the body. The oesophagus, including the bulb, is 1.75–2.25 mm. long. Of this length the pharynx occupies about 0.26–0.3 mm. The bulb measures 0.25–0.3 mm. in length and 0.28–0.35 mm. in width. The intestine is very wide for a short distance from its junction with the oesophagus, and then becomes very narrow until a short distance before the rectum, where it widens out again into an expanded bulb. The nerve-

ring is situated at 0.5–0.55 mm., and the excretory pore at 1.1–1.45 mm., from the anterior end.

The tail, in both sexes, has a minute terminal spike. In the male the tail measures 0.1–0.12 mm. in length. The caudal end is so abruptly truncate as to appear cut off almost at right angles to the longitudinal axis of the body. The sucker and

Fig. 70.

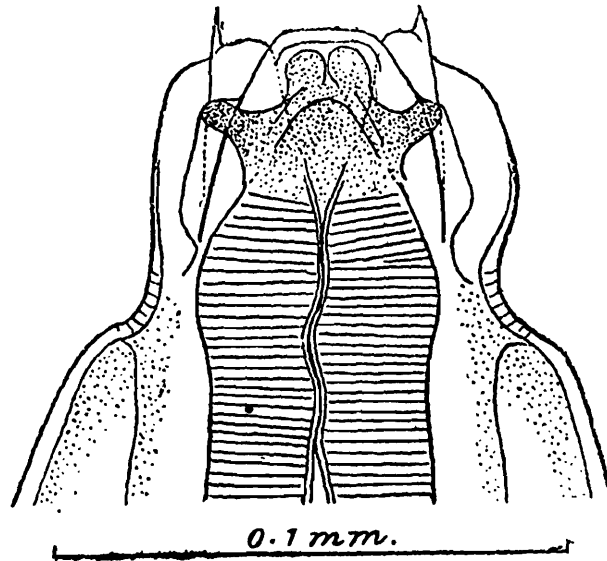

Fig. 71.

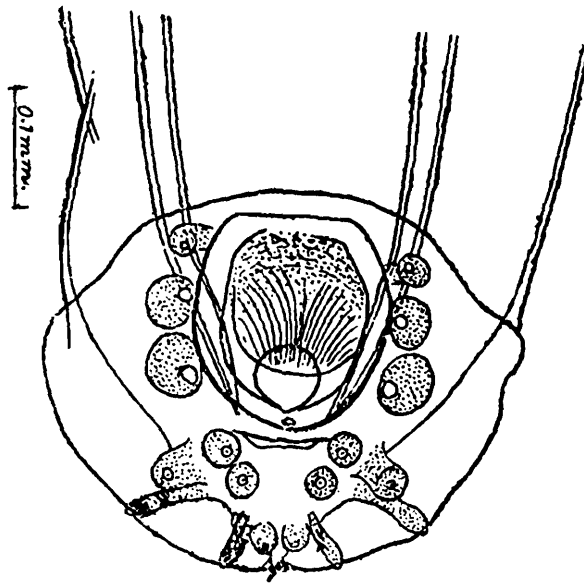

Fig. 70.—*Strongyluris calotis*. Anterior end of female; dorsal view.
(After Baylis and Daubney.)

Fig. 71.—*Strongyluris calotis*. Posterior end of male; ventral view.
(After Baylis and Daubney.)

the cloaca thus open almost posteriorly. The sucker is relatively very deep, measuring 0.12–0.16 mm. in depth and 0.14–0.17 mm. in width. There are ten pairs of caudal papillæ, seven of which are postanal. The spicules are

subequal, 0.75–0.8 mm. in length, the left being slightly longer than the right.

The tail of the female is very short (0.2–0.25 mm.), and is bluntly rounded behind, with the exception of the little terminal spike. There is a pair of papillæ at 0.05 mm. from the tip. The vulva is a transverse slit with rather prominent lips, situated at 4.7–5.65 mm. from the posterior end. The vagina runs forward for a short distance from the aperture, and then turns back upon itself to run posteriorly. The eggs are oblong-oval and measure 0.0875–0.0975 × 0.05–0.0525 mm. When ready for laying they contain an embryo which is just beginning to elongate.

5. Genus **SPINICAUDA** Travassos, 1920.

Synonym :—*Sonsinia* Baylis and Daubney, 1922.

Lateral fields conspicuous, composed of single rows of large cells. Lips subtriangular, expanded anteriorly and laterally as in *Strongyluris*, without "cordons." Œsophagus with a short pharynx and a posterior bulb. Tail of male tapering, without alæ. Papillæ small and sessile. Spicules short, subequal. An accessory piece present. Uterine branches parallel. Eggs with thick, sometimes rugose shells. Adult worms in the alimentary canal of lizards and chameleons.

Genotype :—*Spinicauda spinicauda* (Olfers, in Rudolphi, 1819).

1. **Spinicauda cophotis** Baylis, 1935. (Fig. 72.)

Hosts :—*Cophotis ceylanica* and *Lyriocephalus scutatus* (Agamid lizards) ; Gammaduwa, Ceylon.

The male measures 6.4–8 mm. in length and 0.25–0.34 mm. in maximum thickness, the female 7.3–9 mm. and 0.24–0.37 mm. respectively (the last measurement excluding the vulvar prominence). The cuticle is very finely striated, and the lateral alæ are very narrow. The diameter of the head, at the base of the lips, is about 0.056–0.068 mm. The œsophagus, measured from the anterior extremity and including the posterior bulb, is about 0.9–1 mm. long in the male and 1–1.16 mm. in the female. At its anterior end there is a pharynx measuring about 0.07–0.08 mm. in length. The diameter of the bulb is 0.15–0.17 mm. in the male and 0.19–0.21 mm. in the female. The nerve-ring, in both sexes, is situated at about 0.3–0.36 mm., and the excretory pore at 0.5–0.57 mm., from the anterior extremity.

The caudal end of the male is curved ventrally. The tail is 0.29–0.38 mm. long, and tapers rapidly to a fine point. The lips of the cloacal aperture are very prominent, the posterior lip forming a large hemispherical swelling. The greatest

outside diameter of the chitinoid ring of the preanal sucker is about 0.06–0.07 mm. There appear to be about sixteen pairs of caudal papillæ, but some of them are very minute, and it is possible that the actual number may be greater. Five pairs are postanal, two of them being subdorsally situated. Of the preanal papillæ, one pair with very prominent, bristle-like terminations is situated on the anterior cloacal lip. Three pairs of relatively large and two pairs of small papillæ are more or less lateral, the remainder subventral. In front of the sucker there is a series of five (?) pairs of extremely small papillæ. The spicules measure 0.64–0.81 mm. in length.

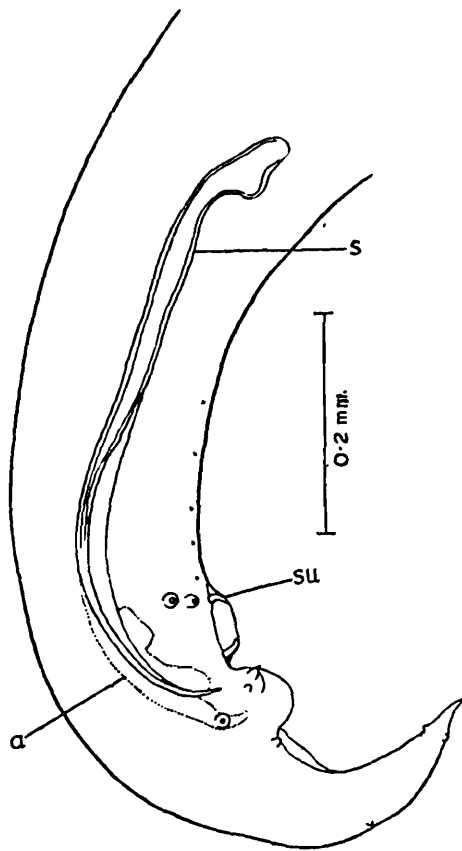

Fig. 72.—*Spinicauda cophotis*. Posterior end of male; lateral view. *a.*, thickening representing accessory piece; *s.*, right spicule; *su.*, sucker. (After Baylis.)

They have a tessellated structure and are of the form found in other members of the genus, with the expanded root bent at an obtuse angle towards the ventral surface. There appear to be thickenings of both the dorsal and ventral walls of the cloaca. The former, which probably represents an accessory piece, but is apparently not chitinized, is about 0.2 mm. long. The latter appears to be partially chitinized and is of an irregular shape.

The tail of the female is about 0.4–0.55 mm. long, and bears a pair of small papillæ at about 0.1 mm. from the tip. The

vulva is situated at 3–3.5 mm. from the anterior end of the body, and is very conspicuous on account of the presence of a large, overhanging anterior lip and of a sudden constriction of the body immediately behind it. The vagina runs at first dorsally or even slightly forward from the vulva, then bends upon itself at right angles and runs posteriorly. The eggs measure $0.07-0.074 \times 0.044-0.046$ mm.

The immature specimens of *Spinicauda* recorded by Baylis and Daubney (1923) from (?) *Lyriocephalus scutatus* very possibly belonged to this species.

6. Genus **AFRICANA** Travassos, 1920.

Lips well developed, without "cordons," expanded anteriorly and laterally into cuticular flanges. Œsophagus with a pharynx and a bulb. Tail of male straight and conical. Caudal alæ somewhat reduced, barely extending beyond the cloaca. Papillæ sessile and mostly small. Spicules long and slender, equal or unequal. No accessory piece. Uterine branches apparently opposed. Eggs with thick shells. Adult worms in the alimentary canal of lizards and chameleons.

Genotype :—*Africana africana* (Gendre, 1909).

1. *Africana varani* Maplestone, 1931. (Fig. 73.)

Host :—Bengal monitor (*Varanus bengalensis*); Zoological Gardens, Calcutta.

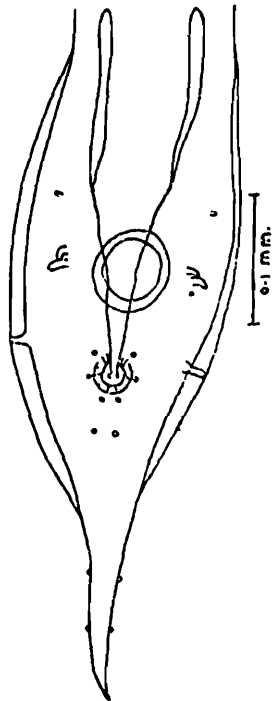

Fig. 73.—*Africana varani*. Posterior end of male; ventral view. (After Maplestone.)

The male measures about 4 mm. in length and 0.192 mm. in maximum thickness, the female about 6 mm. and 0.35 mm. respectively. Lateral alæ are present, measuring (in the male) about 0.016 mm. in width. The œsophagus, including the bulb, is 0.83 mm. long in the male and 1.01 mm. in the female. The cervical papillæ are situated at 0.43 mm. (in the female), and the excretory pore at about 0.49 mm. (in the male), from the anterior end.

The posterior end of the male shows a fusiform swelling which reaches its greatest width at about the level of the sucker. There are 13 pairs of caudal papillæ and a small median papilla in front of the sucker. The spicules are equal and measure about 0.34 mm. in length. The proximal half of the spicules is relatively stout, the distal half slender and filiform.

The tail of the female is sharply pointed and measures 0.376 mm. in length. The vulva is situated at 2.7 mm. from the anterior end of the body, and the vagina runs posteriorly from it. The eggs are oval and measure 0.068–0.072 × 0.036–0.041 mm.

Subfamily SUBULURINÆ Travassos, 1914.

Lips much reduced or absent. A cylindrical buccal capsule present. Œsophagus usually without distinct pharyngeal portion, but with a posterior bulb. Preanal sucker of male antero-posteriorly elongated, fusiform or elliptical, usually without chitinoid border. Vulva usually at about the middle of the body, occasionally posterior. Eggs usually contain embryos when laid.

1. Genus **SUBULURA** Molin, 1860.

Synonym :—*Allodapa* Diesing, 1861; *Latibuccana* Patwardhan, 1935.

Lips rarely apparent. Mouth usually oval or hexagonal, with its long axis dorso-ventral. Buccal capsule with three teeth at its base. Lateral cervical alæ frequently present. Tail of male with more or less well-developed alæ. Caudal papillæ sessile, usually eleven pairs or fewer. Spicules equal or unequal, slender and alate. An accessory piece present. Preanal sucker fusiform. Eggs subglobular, usually containing embryos when laid. Adult worms in the alimentary canal of mammals and birds.

Genotype :—*Subulura acutissima* Molin, 1860.

Key to Species.

Parasites of birds	1.
Parasites of mammals	3.
1. Spicules about 0.5 mm. long	<i>turnicis</i> , p. 154.
Spicules over 1 mm. long	2.
2. Spicules 1.1 mm. long; caudal papillæ of male ten pairs	<i>galloperdicis</i> , p. 153.
Spicules about 2 mm. long; caudal papillæ of male 15 pairs	<i>multipapillata</i> , p. 156.
3. Parasite of squirrels	<i>andersoni</i> , p. 151.
Parasite of slender loris	<i>sarasinorum</i> , p. 153.

1. ***Subulura andersoni*** (Cobbold, 1876) Railliet and Henry, 1914. (Fig. 74.)

Synonyms:—*Ascaris andersoni* Cobbold, 1876; *Latibuccana funambulensis* Patwardhan, 1935.

Hosts:—*Sciurus* sp. (cæcum), North-eastern India (Cobbold); squirrel (cæcum and intestine), Kanthalai, India

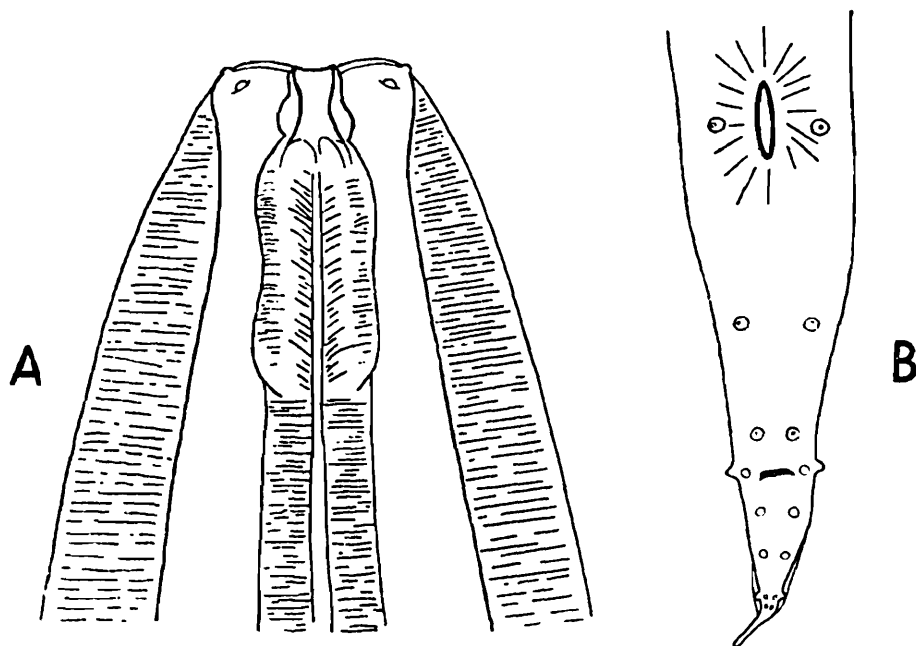

Fig. 74.—*Subulura andersoni*. A, anterior end, ventral view; B, posterior end of male, ventral view. (After Thwaite.)

(Thwaite); *Funambulus pennanti* (intestine), Nagpur, Central Provinces (Patwardhan).

According to Cobbold's original description, the male measures up to $\frac{1}{2}$ in. (about 12.5 mm.) in length, the female $\frac{3}{4}$ in. (about 19 mm.), and the maximum thickness is 1 mm. The tail of the male has a "minute oval-shaped spine" at the tip. The spicules are long, arcuate and slightly winged at the extremity. The tail of the female has the terminal

spine "continuous and scarcely distinct." The eggs are nearly spherical and measure $1/500-1/400$ in. (or about 0.05–0.063 mm.) in diameter.

Thwaite (1927) has given a much fuller account of a species which he regards as probably identical with Cobbold's. In this form the male measures 13.5–14.9 mm. in length and 0.36–0.43 mm. in maximum thickness, the female 15.9–23.1 mm. and 0.4–0.53 mm. respectively. In both sexes the anterior end is curved in the form of a hook. The cuticle has fine transverse striations. Cervical alæ extend from the anterior end for a distance of about 0.9 mm. (in the male), and have a maximum width of about 0.075 mm. The aperture of the mouth is fusiform. The buccal capsule is 0.057–0.07 mm. long, and has a dorsal and two subventral teeth at its base. There is a distinct pharynx, which is somewhat thicker than the anterior part of the œsophagus proper. The latter has a club-shaped swelling posteriorly, joined by a narrow neck to the bulb, which measures 0.24–0.287 mm. in length and 0.207–0.276 mm. in width. The total length of the œsophagus, including the pharynx and the bulb, is 1.68–2.4 mm. Cervical papillæ were not observed. The excretory pore is situated at about 0.46–0.56 mm. from the anterior end, and the nerve-ring somewhat in front of the excretory pore.

The posterior end of the male is curled. The tail measures 0.25–0.3 mm. in length, including a short terminal spike. The sucker is about 0.115 mm. long, and is situated at a distance of 0.5–0.62 mm. from the cloacal aperture. There are ten pairs of caudal papillæ (fig. 74, B). The spicules are equal or subequal, and measure from 0.85 mm. to just over 1 mm. in length. They are provided with alæ. The accessory piece is 0.155–0.175 mm. long.

The tail of the female measures up to 1.13 mm. in length, and has a terminal spike. The vulva is situated at 6.5–8 mm. from the anterior end. The vagina at first runs forward from it for a short distance and then turns posteriorly. In the gravid female the uterine branches extend from the bulb of the œsophagus to the posterior end of the body. The eggs measure about 0.078×0.06 mm., and contain embryos when laid.

The form described under the name of *Latibuccana funambulensis* by Patwardhan (1935) seems to be almost certainly identical with that described by Thwaite, although the sucker, the anterior pair of preanal papillæ and three other pairs of papillæ in the male appear to have been overlooked.

2. **Subulura sarasinorum** (Meyer, 1896) Railliet and Henry, 1914.

Synonym :—*Filaria sarasinorum* Meyer, 1896.

Host :—Slender loris (*Loris* [*Stenops*] *lydekkerianus* [*Loris gracilis*]) (intestine), Ceylon (Meyer); Zoological Gardens, Calcutta (Baylis and Daubney).

According to Meyer's description, the male measures 7.5–8.5 mm. in length and 0.45–0.52 mm. in maximum thickness, the female 10–11.25 mm. and 0.57–0.7 mm. respectively. The cervical alæ extend for 1/6 of the total length, or to about the posterior end of the œsophagus. The latter is 1.4 mm. long.

The tail of the male is straight, rapidly tapering and finely pointed, and measures 0.25 mm. in length. There are ten pairs of caudal papillæ, of which four are preanal and six postanal. The spicules measure 2.5 mm. in length and 0.016 mm. in width.

The tail of the female tapers more gradually than that of the male, but is also finely pointed. It measures 0.75 mm. in length. The vulva is situated at about the middle of the body. The eggs are oval and measure 0.081 × 0.065 mm.

3. **Subulura galloperdicis** Baylis and Daubney, 1922. (Fig. 75.)

Host :—Red spur-fowl (*Galloperdix spadicea*) (intestine); Zoological Gardens, Calcutta.

The male measures 9.5–10 mm. in length and 0.3 mm. in maximum thickness, the female 11.5–12.5 mm. and about 0.4 mm. respectively. The diameter of the head is about 0.08 mm. There are narrow cervical alæ which extend for a distance of about 1 mm. from the anterior end. The buccal capsule is 0.06 mm. long. Its width expands from 0.023 mm. anteriorly to 0.031 mm. at the posterior end. The height of the three teeth at its base is about 0.013 mm. The œsophagus is 1.7 mm. long, including the bulb, which is nearly spherical and has a diameter of 0.2 mm. There is a prebulbar swelling 0.14 mm. thick. The nerve-ring is situated at 0.27 mm., and the excretory pore at 0.45 mm., from the anterior end.

The tail of the male is 0.21 mm. long, and has a slender terminal spike. The sucker is spindle-shaped and is situated at about 0.65 mm. from the cloacal aperture. There are eleven pairs of caudal papillæ, four of which are preanal, two adanal and five postanal. The two pairs of adanal papillæ are situated on the anterior lip of the cloaca, one laterally to the other. The spicules are equal and measure 0.76–0.8 mm. in length and about 0.02 mm. in width. The

cylindrical axis of the spicule measures about 0.011 mm. in diameter. The edges of the two alæ with which each spicule is provided are finely serrated. The accessory piece is slender and curved. It measures about 0.18 mm. in length and has a spur at about 0.06 mm. from its anterior end.

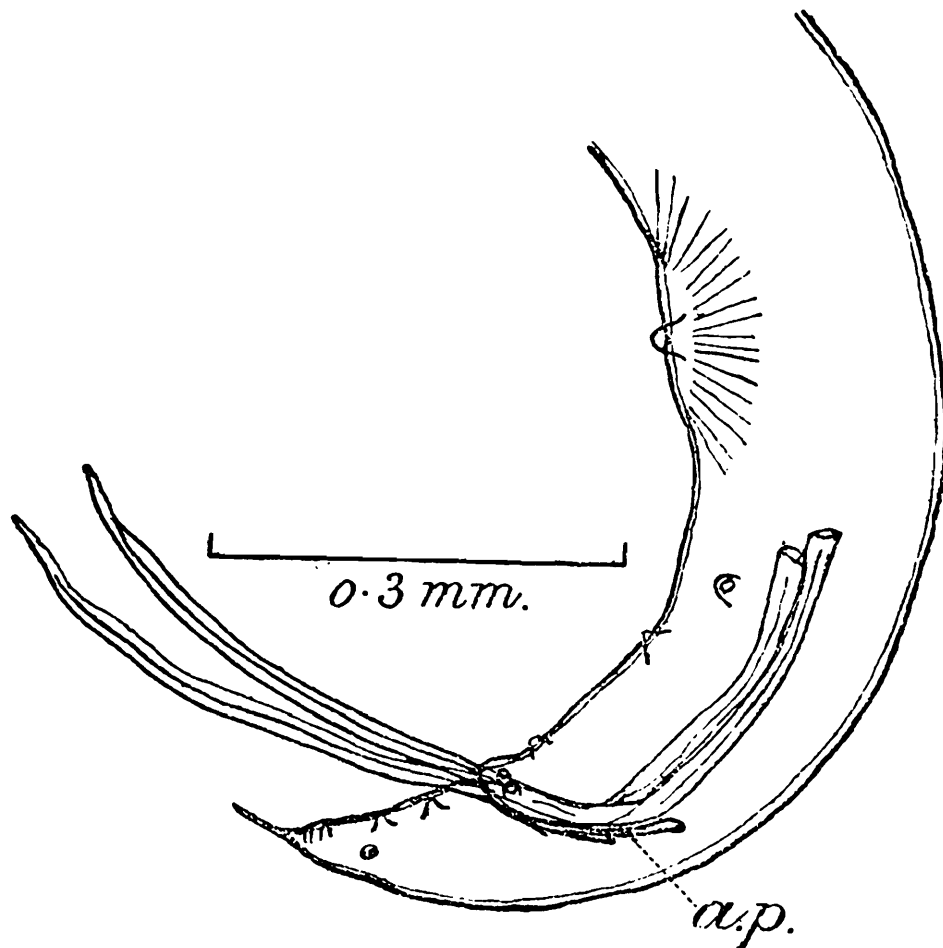

Fig. 75.—*Subulura galloperdicis*. Posterior end of male; lateral view. *a.p.*, accessory piece. (After Baylis and Daubney.)

The tail of the female is 1.1 mm. long. The vulva is situated in the anterior half of the body, dividing the total length in the ratio of 3 : 4. The eggs measure 0.065 × 0.035 mm., and contain fully-formed embryos when laid.

4. *Subulura turnicis* Maplestone, 1931. (Fig. 76.)

Hosts :—Little quail (*Turnix dussumieri*) (intestine) (Maplestone); button-quail (*Turnix* sp.) (Baylis and Daubney); Zoological Gardens, Calcutta.

According to Maplestone's description, the male of this species measures 13 mm. in length and 0.42 mm. in maximum thickness, the female 17.5 mm. and 0.42 mm. respectively. The cervical alæ are about 0.8–1 mm. in length. The mouth is surrounded by six lips, each of which bears a papilla. The buccal capsule is 0.056 mm. long and 0.032 mm. in width, and has three broad teeth at its base. The œsophagus is

about 1–1.2 mm. long, including the bulb, which has a diameter of 0.17–0.18 mm.

The tail of the male is 0.22 mm. long. The sucker is oval and has a length of about 0.12 mm. It is situated at a distance of about 0.36 mm. from the cloacal aperture. Narrow caudal alæ extend from a little in front of the cloaca to the posterior end. There are twelve pairs of caudal papillæ, of which five

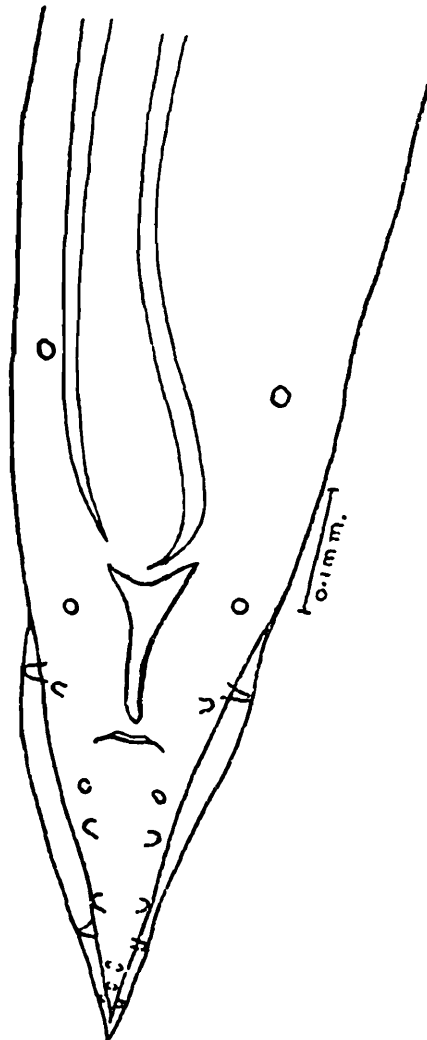

Fig. 76.—*Subulura turnicis*. Posterior end of male; ventral view.
(After Maplestone.)

are preanal and seven postanal. The most anterior pair of papillæ is just in front of the sucker. The spicules are equal and measure 0.84 mm. in length. The accessory piece is 0.14 mm. long.

The tail of the female is 0.5 mm. long, and narrows suddenly near the tip to form a fine terminal spike. There is a pair of papillæ at about 0.13 mm. from the tip. The vulva is situated at about 7.8 mm. from the anterior end of the body. The eggs measure 0.068–0.074 × 0.056 mm.

Maplestone regards the specimens recorded by Baylis and Daubney (1922), and referred by them to *Subulura* sp., as probably of this species. These were two females, one of which was damaged. They appear to have been rather smaller than Maplestone's examples, the complete specimen being only 14 mm. long. The buccal capsule measured only 0.035 mm. in length and 0.02 mm. in width. The eggs, however, were longer than in Maplestone's material, measuring 0.085×0.056 mm. Some of them contained fully-formed embryos.

5. *Subulura multipapillata* (Chandler, 1926). (Figs. 77 & 78).

Synonym :—*Allodapa multipapillata* Chandler, 1926.

Host :—Red-crested wood-quail (*Rollulus rouloul*) (cæca and large intestine); Zoological Gardens, Calcutta (Chandler, Maplestone).

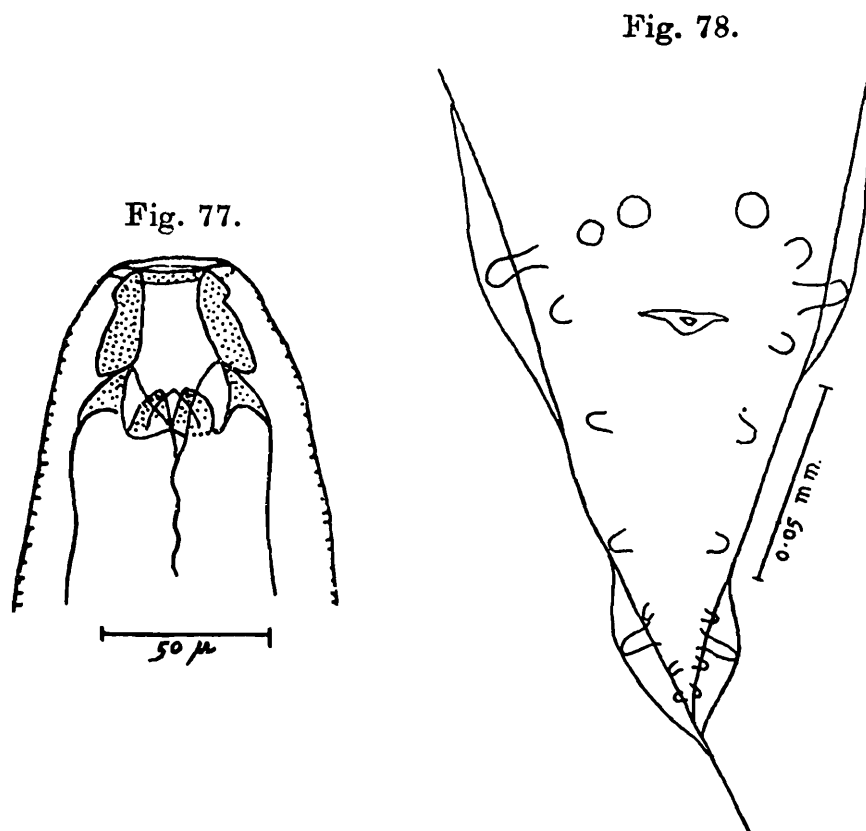

Fig. 77.—*Subulura multipapillata*. Head. (After Chandler.)

Fig. 78.—*Subulura multipapillata*. Posterior end of male; ventral view. (After Maplestone.)

The male measures 6–7 mm. in length and 0.26–0.28 mm. in maximum thickness, the female 8–10 mm. and about 0.35 mm. respectively. The diameter of the head is 0.07–0.075 mm. Short and narrow cervical alæ are present. The buccal capsule consists of two portions, the anterior

portion being narrow and cylindrical, with very thick walls, the posterior portion wider and subglobular. The latter contains three teeth, 0.015–0.016 mm. long, at its base. The length of the buccal capsule is 0.056 mm., its width 0.022 mm. anteriorly and 0.032 mm. posteriorly. The œsophagus measures 1.12–1.25 mm. in length, including the bulb, which is 0.2–0.24 mm. long and 0.2–0.25 mm. wide. The nerve-ring is situated at about 0.26 mm. from the anterior end.

The tail of the male is 0.23 mm. long. The sucker is situated at a distance of about 0.43 mm. from the cloacal aperture. The caudal alæ, according to Maplestone (1931), are composed of two portions separated by a gap, one portion being situated in the cloacal region, the other towards the tip of the tail. There are 15 pairs of caudal papillæ, of which seven are postanal. The most anterior pair of papillæ is well in front of the sucker. Two pairs of papillæ project laterally into the two portions of the alæ, one being near the cloaca, the other the third pair from the posterior end. The spicules are equal and tubular, and measure about 0.78 mm. in length and 0.022 mm. in width. The accessory piece, according to Chandler, is “apparently in two parts, a narrow stout chitinous piece dorsal to the tips of the spicules, about 145 μ long, and a thin flat piece ventral to the tips of the spicules, about 170 μ long.”

The tail of the female, according to Chandler, is about 2 mm. long, “the anterior half of it tapering very little, the posterior fourth tapering very rapidly.” The vulva is inconspicuous, and is situated in front of the middle of the body, dividing the total length in the ratio of about 3:5. The eggs measure 0.056–0.063 \times 0.034–0.042 mm., and contain fully-formed embryos when laid.

3. Family KATHLANIIDÆ Travassos, 1918, *emend.*

Medium-sized or small parasitic forms. Musculature of the body usually of the meromyarian type. Lips well developed, entire or subdivided. Œsophagus preceded either by a chitinous buccal capsule or by a muscular pharynx with a cuticular lining, unarmed or containing tooth-like structures. At the posterior end of the Œsophagus there is a prebulbar swelling and also a large muscular bulb, separated from the former by a rather narrow "neck," the two swellings and the neck together giving the appearance of a dumb-bell-shaped or flask-shaped bulb. Tail of male without alæ. The ventral muscles in the preanal region of the male are frequently aggregated to form one or more fusiform sucker-like organs without chitinous border. Spicules two, equal or subequal, usually falciform and broadly alate. An accessory piece usually present. Vulva at about the middle of the body or somewhat behind it. Uterine branches generally opposed. The worms may be oviparous or viviparous.

Key to Genera.

Lips simple or bilobed . . .	1.
Lips divided into several lobes, or complex.	4.
1. Pharynx containing three longitudinal series of teeth	CRUZIA, p. 179.
Pharynx without teeth.	2.
2. Pharynx with an anterior non-muscular portion	PROBSTMAYRIA, p. 182.
Pharynx without anterior non-muscular portion	3.
3. Oral cavity surrounded by a continuous chitinous ring	SPIRONOURA, p. 163.
Oral cavity with three separate double horse-shoe-shaped supports at its angles . .	ZANCLOPHORUS, p. 174.
4. Dorsal lip trident-shaped; ventro-lateral lips armed with groups of lancet-like teeth	CISSOPHYLLUS, p. 181.
Each lip divided into five or more lobes	5.
5. Spicules of male relatively short.	KATHLANIA, p. 158.
Spicules of male about as long as the body.	TONAUDIA, p. 162.

1. Genus **KATHLANIA** Lane, 1914.

Synonyms :—*Pseudoheterakis* Travassos, 1917 ; *Oxysoma* Schneider, 1866 (part).

Head separated from body by a slight constriction. Lateral alæ present. Each lip is subdivided into a large main lobe and several smaller accessory lobes. In the mid-ventral

position there is an additional unpaired lobe or interlabium. The two lateral and four submedian cephalic papillæ are situated on certain of the accessory lobes of the lips, while each main lobe has a pair of very small papillæ on its inner surface. A buccal capsule present, triangular in section and with three tooth-like structures at its entrance. The tail of the male ends in a long spike. A muscular preanal sucker-like organ present. Caudal papillæ sessile. Spicules subequal, broadly alate. A large Y-shaped accessory piece present. Vulva behind the middle of the body. The anterior uterine branch turns to run posteriorly parallel with the other. Eggs with thin, finely striated shells, containing embryos when laid. Adult worms in the alimentary canal of marine turtles and fishes.

Genotype :—*Kathlania leptura* (Rud., 1819).

Key to Species.

Parasite of turtle	.. .	<i>leptura</i> , p. 159.
Parasite of Elasmobranch fish		<i>chiloscyllii</i> , p. 160.

1. *Kathlania leptura* (Rud., 1819) Travassos, 1918.

Synonyms :—*Ascaris leptura* Rudolphi, 1819; *Oxysoma lepturum* Schneider, 1866; *Kathlania kathlena* Lane, 1914; *Pseudo-heterakis leptura* Travassos, 1917.

Host:—Green turtle (*Chelonia mydas*) (intestine); recorded from Ceylon (Lane), as well as other parts of the world.

The following description is taken from Lane's (1914, b) account. The male measures about 13 mm. in length and 0.6 mm. in maximum thickness, the female about 15 mm. and 0.7 mm. respectively. The "head" is about 0.08–0.1 mm. long and 0.17–0.21 mm. wide at its base. The transverse striations of the cuticle are at intervals of about 2 μ . The lateral alæ begin at 0.55–0.65 mm. from the anterior end, and measure 0.01–0.025 mm. in width. Each of the lips is divided into a main lobe and four accessory lobes. Of the three tooth-like structures at the entrance to the buccal capsule, the dorsal is broad and low, the two subventral more prominent and triangular. The total length of the œsophagus is about 5.67 mm., the buccal capsule measuring 1.6 mm., the cylindrical portion of the œsophagus 3.75 mm., the prebulbar swelling 0.12 mm. and the bulb 0.2 mm. The nerve-ring is situated at 0.6 mm., and the cervical papillæ at 4 mm., from the anterior end.

The tail of the male is 2 mm. long. The sucker measures 0.4 mm. in length and is situated at a distance of 1 mm. from the cloacal aperture. There are eleven pairs of caudal papillæ and one unpaired papilla, which lies in front of the

cloacal opening. The three most posterior papillæ on each side form a group of which the first and second may coalesce to form a double papilla, and are subventral. The fourth and fifth are lateral and smaller. The next three are preanal, subventral and situated close together. The three anterior preanal papillæ are larger and more prominent. One lies at the level of the sucker, the other two between the sucker and the cloaca. The spicules are about 0.55 mm. long and have a maximum width of about 0.06 mm. Lane describes them as having "their more solid portions arranged in such a manner as to give the impression, at first sight, of there being two spicules on each side, one dovetailed into the other." The accessory piece is massive and measures 0.35 mm. in length. Its bifurcated portion occupies about half its length.

The tail of the female is 4.5 mm. long, and bears a pair of papillæ at 0.5 mm. from the anus. Immediately behind the vulva the cuticle of the ventral surface is raised into a series of transverse ridges, of which there are from seven to fifteen. These ridges form, according to Lane, "a ladder-like patch 0.1 mm. wide and from 0.07 to 0.18 mm. long." The vagina is 1-1.75 mm. long, and may be somewhat dilated just before giving off the two uterine branches. The anterior of these turns posteriorly after a course of about 1 mm. The eggs measure 0.09×0.045 mm.

2. *Kathlania chiloscyllii* Thwaite, 1927 (Figs. 79 & 80.)

Host :—A dogfish (*Chiloscyllium indicum*); Ceylon Pearl Banks.

The male measures 8.3-10 mm. in length and 0.4-0.46 mm. in maximum thickness, the female 10-12.6 mm. and 0.43-0.5 mm. respectively. The cuticular striations are very fine. The lateral alæ begin at about 0.65 mm. from the anterior end, and end in the male just in front of the sucker, and in the female at about the level of the vulva. The "head" is about 0.055-0.07 mm. long and 0.13-0.16 mm. in width. Each of the lips consists of a main lobe and a variable number of accessory lobes. According to Thwaite, the number of accessory lobes between two of the main lobes may vary between six and nine. The teeth in the buccal cavity are roughly pentagonal in outline. The total length of the œsophagus is 2.15-2.92 mm. The buccal capsule is thick-walled and triangular in section. Its length is about 0.07-0.11 mm. The bulb measures about 0.23×0.3 mm. The cervical papillæ are situated at about 1.78 mm. from the anterior end.

The tail of the male measures 1.25-1.5 mm. in length. The sucker is oval and measures 0.2 mm. in length and about 0.1 mm. in depth. It is situated at a distance of about

0.35 mm. from the cloacal aperture. There are eleven pairs of caudal papillæ, of which six are preanal and five postanal. The spicules measure 2–2.6 mm. in length and are relatively slender and sharply pointed.

The tail of the female is 2.77–2.95 mm. long. The vulva is situated at 4.58–5.7 mm. from the posterior end. “From this

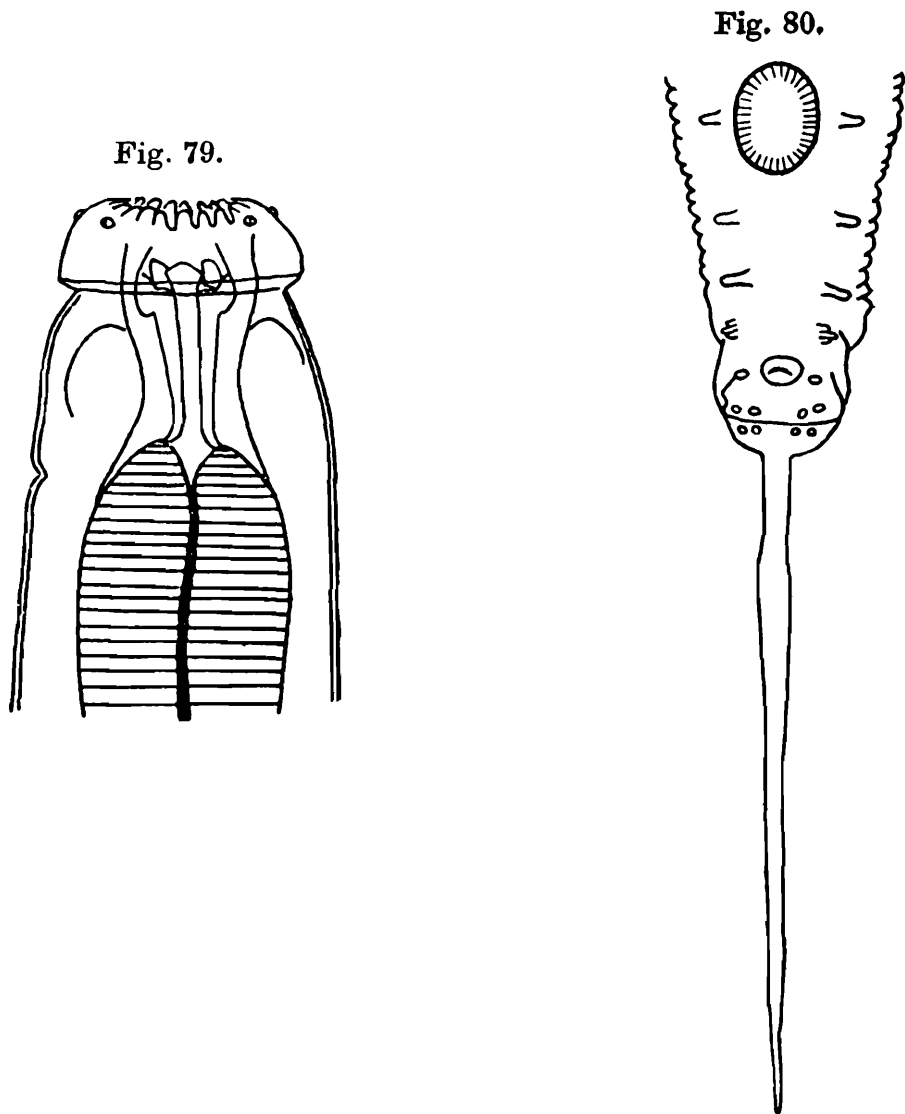

Fig. 79.—*Kathlania chiloscyllii*. Anterior end; dorsal view. (After Thwaite.)

Fig. 80.—*Kathlania chiloscyllii*. Posterior end of male; ventral view. (After Thwaite.)

point the vagina proceeds backwards for a short distance, then curves round and passes forwards where it divides into two uteri at a point 2.13 mm. from its commencement.” The eggs measure about 0.08×0.045 mm., and contain embryos when laid.

2. Genus **TONAUDIA** Travassos, 1919.

Head separated from body by a well-marked constriction, the posterior margin of the head forming a sharp angle. Lateral alæ present. Lips and buccal capsule as in *Kathlania*. Tail of male ends in a long spike, which is directed dorsally. A muscular preanal sucker-like organ present. Spicules extremely long and slender, reaching anteriorly to the middle of the œsophagus when not extruded, and with narrow alæ. A Y-shaped accessory piece present, not strongly chitinized. Vulva slightly behind the middle of the body. Vagina very long and coiled. Female organs in other respects as in *Kathlania*. Adult worms in alimentary canal of marine turtle.

Genotype :—*Tonaudia tonaudia* (Lane, 1914).

1. **Tonaudia tonaudia** (Lane, 1914) Travassos, 1919. (Fig. 81.)

Synonym :—*Kathlania tonaudia* Lane, 1914.

Host :—Green turtle (*Chelonia mydas*) (intestine); Ceylon.

The male measures 11.5 mm. in length and 0.6 mm. in maximum thickness, the female 15 mm. and 0.65 mm. respectively. The head is 0.08 mm. long and 0.2 mm. wide at its base. The cuticular striations are 2 μ apart. The lateral alæ begin at 0.5–0.7 mm. from the anterior end, and have a maximum width of 0.025 mm. The oral cavity contains three teeth, of similar shape, at its base. The total length of the œsophagus is about 4 mm., the buccal capsule measuring 0.11 mm., the prebulbar swelling 0.2 mm. and the bulb 0.3–0.35 mm. The nerve-ring is situated at 0.5 mm., and the cervical papillæ at 2.5 mm., from the anterior end.

The tail of the male is 1.5 mm. long and curves at first ventrally, then sharply dorsally. The sucker measures 0.22 mm. in length and is situated at 0.5 mm. from the cloacal aperture. There are eight pairs of caudal papillæ and a large, median preanal papilla. The sixth and seventh papillæ from the posterior end on each side may coalesce to form a double papilla. The spicules are extremely long and slender, measuring 12 mm. in length and 0.03 mm. in width. They are provided with alæ except for a distance of 0.11 mm. from the tip. The accessory piece is thin and delicate and measures 0.25 mm. in length.

The tail of the female is 2.5 mm. long, and bears a pair of papillæ at 0.6 mm. from the anus. The vulva is situated at about 1 mm. behind the middle of the body. Its anterior lip is somewhat prominent. The vagina is long and coiled, measuring 8 mm. in length. The eggs measure 0.1 \times 0.045 mm.

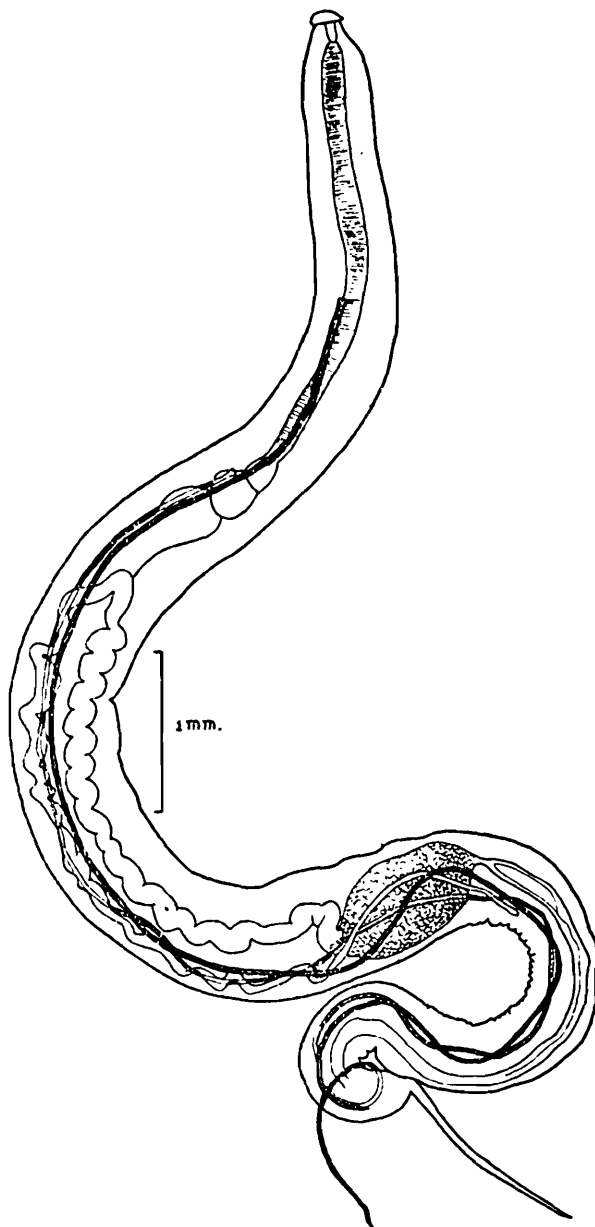

Fig. 81.—*Tonaudia tonaudia*. Male; lateral view.
(After Lane.)

3. Genus **SPIRONOURA** Leidy, 1856.

Synonyms :—*Spirura* Diesing, 1861, *nec* Blanchard, 1849; *Falcaustra* Lane, 1915; *Florencioia* Travassos, 1919.

Head frequently wider than neck, occasionally not distinct. Lateral fields wide. Lateral alæ absent. Lips entire or bilobed, each bearing two outer and two inner papillæ. The pulp of each outer papilla sends a branch to the corresponding inner papilla. Oral cavity supported by a continuous cuticular ring. A muscular pharynx present, with narrow lumen. Tail in both sexes tapering and pointed. Male with ten or more pairs of caudal papillæ (of which three pairs are preanal) and an unpaired preanal papilla. Preanal caudal

muscles of male sometimes aggregated into one or several fan-shaped sucker-like organs. Spicules equal, relatively short, sickle-shaped, usually broadly alate. An accessory piece usually present, sometimes imperfectly chitinized or absent. Vulva towards the posterior third of the body. Eggs usually large, thick-shelled, oval, laid at various stages of development, according to species. Adult worms in the intestine of reptiles, batrachians and freshwater fishes.

Genotype :—*Spironoura gracile* Leidy, 1856.

Key to Species.

Preanal sucker-like organ present	1.
Preanal sucker-like organ absent	2.
1. Parasite of fish.	<i>barbi</i> , p. 165.
Parasite of freshwater tortoise	<i>onama</i> , p. 173.
2. Spicules of male more than 0.5 mm. long	3.
Spicules of male not more than 0.5 mm. long.	4.
3. Spicules about 1 mm. long; œsophagus considerably more than 2 mm. long	<i>leptocephala</i> , p. 167.
Spicules about 0.8 mm. long; œsophagus about 2 mm. long	<i>testudinis</i> , p. 164.
4. Caudal papillæ of male 16 to 18 pairs	<i>stewarti</i> , p. 171.
Caudal papillæ of male ten pairs	5.
5. Parasite of freshwater tortoises	<i>falcata</i> , p. 168.
Parasite of frog	<i>brevispiculata</i> , p. 170.

1. ***Spironoura testudinis*** (Baylis and Daubney, 1922) Yorke and Maplestone, 1926. (Fig. 82.)

Synonym :—*Falcaustra testudinis* Baylis and Daubney, 1922.

Host :—*Testudo elongata*; Assam (Tura, foot of Garo Hills).

The male measures 10.2–10.4 mm. in length and 0.6 mm. in maximum thickness, the female 9.2–11.5 mm. and 0.6–0.75 mm. respectively. The diameter of the head is 0.15–0.16 mm. This is followed by a slightly narrower neck. The buccal cavity measures about 0.05 mm. in length and 0.03 mm. in diameter. The total length of the œsophagus is 1.7–2.1 mm., the pharynx measuring 0.13–0.14 mm., the prebulbar swelling and the bulb together 0.4–0.45 mm. The diameter of the latter is 0.26–0.27 mm. The nerve-ring is situated at 0.44–0.45 mm., the prominent cervical papillæ at 1.03–1.1 mm., and the excretory pore at 1.22–1.26 mm., from the anterior end.

The tail of the male measures 0.81 mm. in length. There is no preanal sucker-like organ. There are eleven pairs of caudal papillæ and a median preanal papilla. The spicules measure 0.8 mm. in length and 0.07 mm. in greatest width. The chitinized portion of the accessory piece is 0.15–0.17 mm. long.

The tail of the female is about 1 mm. long, and bears a pair of papillæ at its middle. The vulva is situated at 3·9–4·7 mm. from the posterior end. The vagina is long, running forward

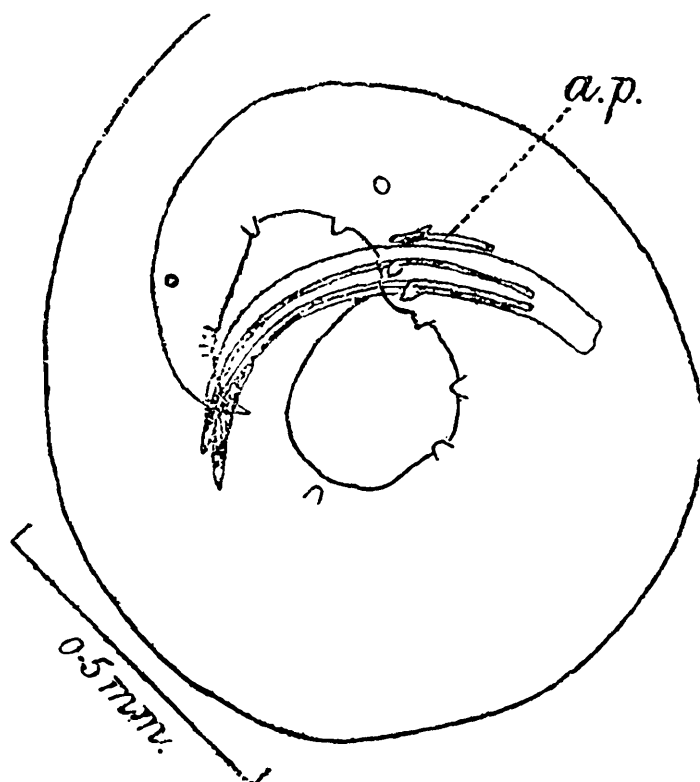

Fig. 82.—*Spironoura testudinis*. Posterior end of male; lateral view
a.p., accessory piece. (After Baylis and Daubney.)

for a distance of 2·3 mm. before giving off the uterine branches. The eggs measure 0·125–0·137 × 0·075–0·087 mm.

2. ***Spironoura barbi*** (Baylis and Daubney, 1922) Yorke and Maplestone, 1926. (Figs. 83 & 84.)

Synonym :—*Falcaustra barbi* Baylis and Daubney, 1922.

Host :—Mahseer (*Barbus tor*); Torsa River, Falakata, Eastern Bengal.

The male measures 15·2–16·5 mm. in length and 0·65–0·7 mm. in maximum thickness, the female 15·5–19·6 mm. and 0·65–1 mm. respectively. The cuticular striations, if present, are excessively fine. The head is almost globular and has a diameter of 0·2–0·22 mm. It is followed by a distinct neck. The total length of the œsophagus is 2·5–2·8 mm. The buccal cavity measures about 0·07 mm. in length, the pharynx 0·1 mm., and the prebulbar swelling and bulb together 0·5–0·59 mm. The bulb has a diameter of 0·34–0·37 mm. The prebulbar swelling is oval and sharply

Fig. 83.

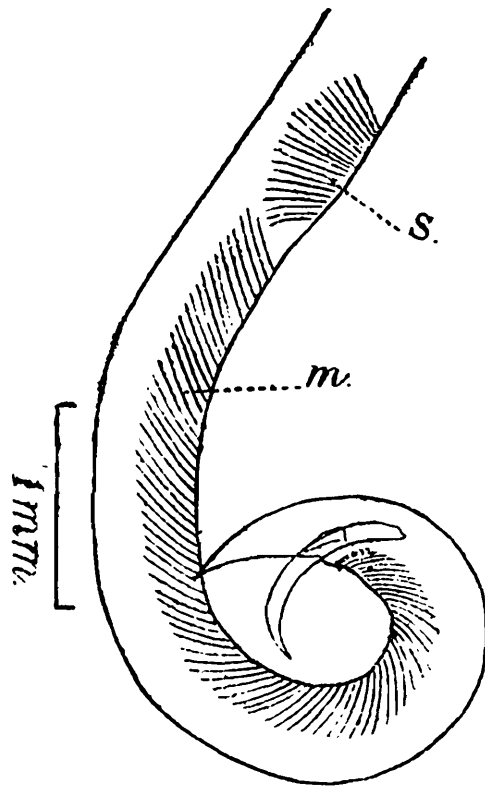

Fig. 84.

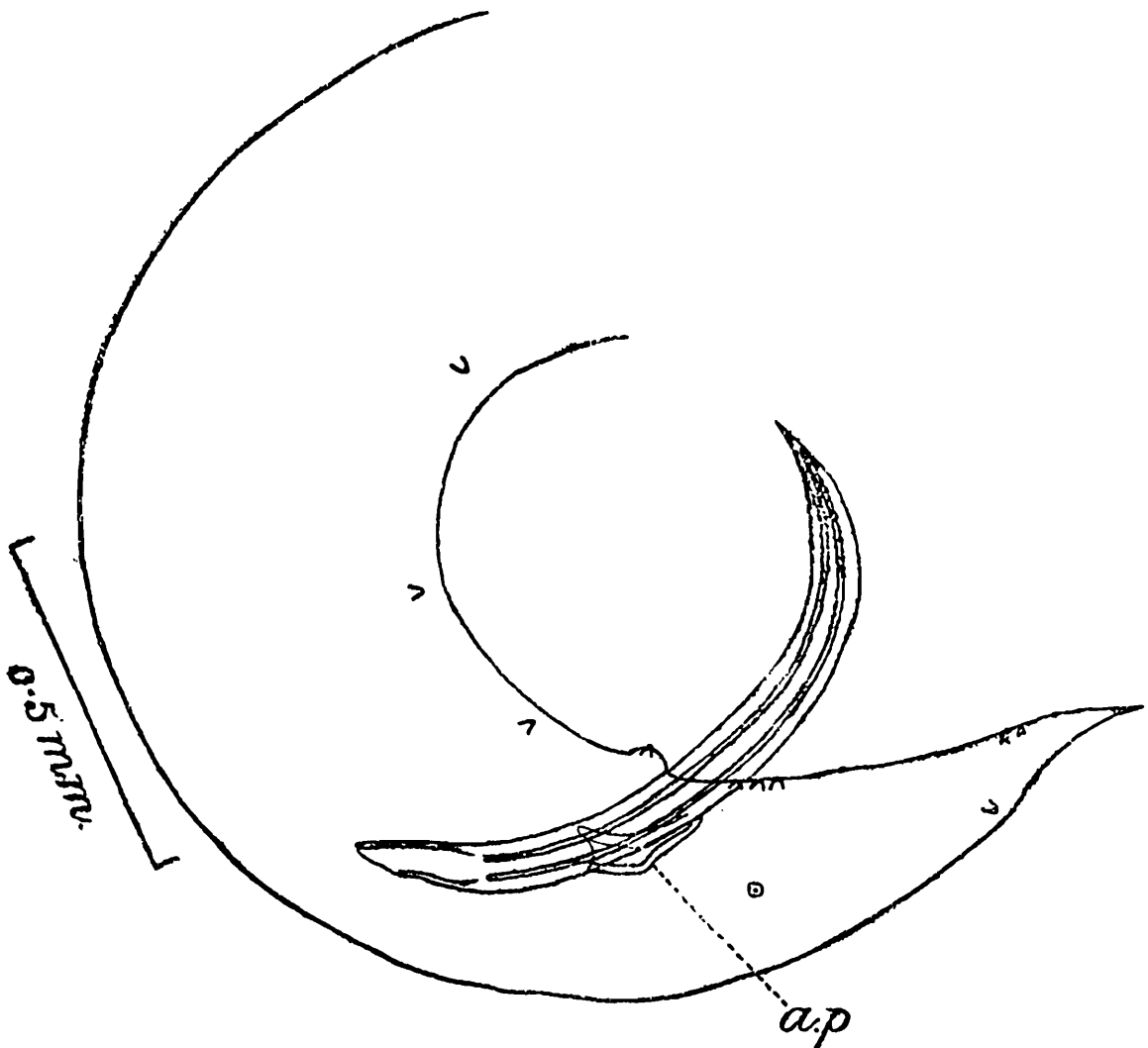

Fig. 83.—*Spironoura barbi*. Posterior end of male; lateral view. *m.*, ventral muscles; *s.*, sucker-like organ. (After Baylis and Daubney.)

Fig. 84.—*Spironoura barbi*. Posterior end of male; lateral view. *a.p.*, accessory piece. (After Baylis and Daubney.)

constricted off both from the preceding portion of the œsophagus and from the bulb. The nerve-ring is situated at 0.4–0.5 mm., the small, but prominent, cervical papillæ at 1.2–1.4 mm., and the excretory pore at 1.55–1.9 mm., from the anterior end.

The tail of the male is about 0.6 mm. long. There is a single fan-shaped sucker-like organ, situated in front of a long series of oblique caudal muscles. The caudal papillæ are very small and inconspicuous. There are ten pairs and an unpaired preanal papilla. The spicules measure 1.13 mm. in length and 0.1 mm. in dorso-ventral width at the widest part, which is near the root. The accessory piece is well chitinized and measures 0.2 mm. in length.

The tail of the female is 0.65–0.8 mm. long, and carries a pair of inconspicuous papillæ at 0.35 mm. from the tip. The vulva is situated at 6.25–7.3 mm. from the posterior end. The vagina is short (about 1 mm.) and nearly straight. The eggs are roundish-oval and measure about 0.075×0.05 mm.

3. *Spiironoura leptcephala* (Baylis and Daubney, 1922). (Fig. 85.)

Synonyms:—*Falcaustra leptcephala* Baylis and Daubney, 1922;
Spiironoura leptcephalum Yorke and Maplestone, 1926.

Host:—Mahseer (*Barbus tor*); Torsa River, Falakata, Eastern Bengal.

This species is easily distinguished from *S. barbi*, which occurs in the same host, by its very narrow head and the absence of a "neck." The male measures up to 19 mm. in length and 1.3 mm. in thickness, the female up to 27 mm. and 1.4–1.8 mm. respectively. The cuticular striations are about 2μ apart. The diameter of the head is 0.1–0.12 mm. The œsophagus measures up to 3.5 mm. in total length, the buccal cavity measuring about 0.05–0.06 mm., the pharynx 0.14–0.17 mm., and the prebulbar swelling and bulb together 0.6–0.67 mm. These are not separated by a sharp constriction. The diameter of the bulb is 0.45–0.47 mm. The nerve-ring is situated at 0.45–0.5 mm., the cervical papillæ, which are prominent and almost bristle-like, at 1.3–1.4 mm., and the excretory pore at 2–2.15 mm., from the anterior end.

The tail of the male measures 0.7–0.85 mm. in length. There is no preanal sucker-like organ. There are ten pairs of caudal papillæ and a median preanal papilla. These are arranged as in *S. barbi*. The spicules are about 1 mm. long and 0.09 mm. wide. There appears to be no chitinized accessory piece.

The tail of the female is 1.1–1.3 mm. long, and bears a pair of very inconspicuous papillæ at 0.6 mm. from the tip. The

vulva is situated at about 11 mm. from the posterior end. The vagina is narrow and runs forward from the vulva. The uterine branches are wide, nearly filling the body-cavity.

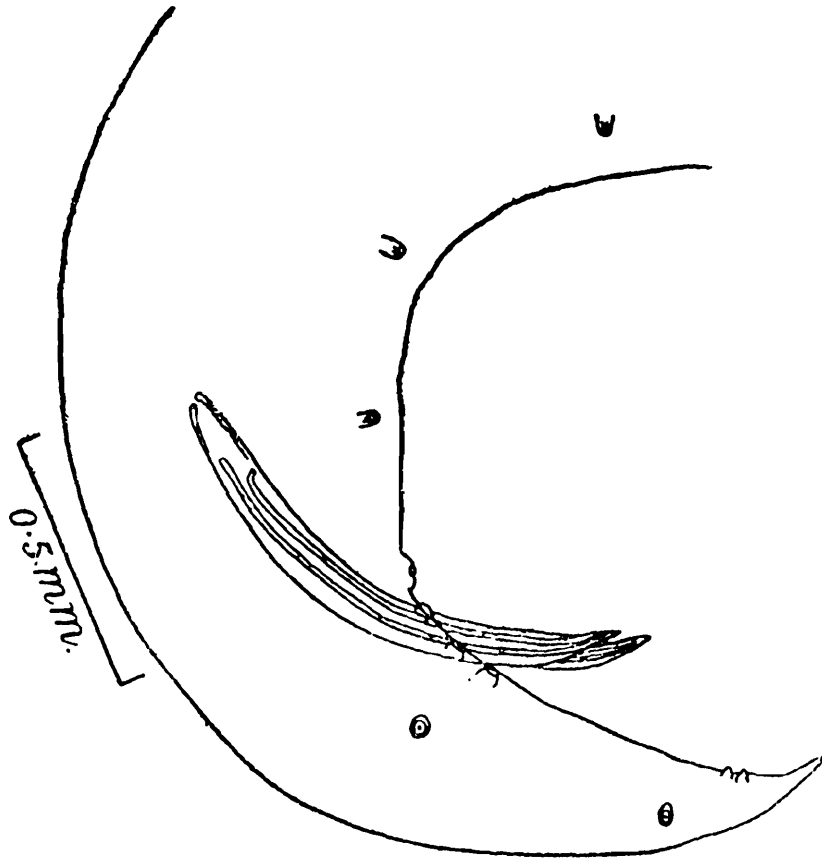

Fig. 85.—*Spiironoura leptocephala*. Posterior end of male; lateral view. (After Baylis and Daubney.)

The eggs are numerous and subglobular, measuring 0.075×0.05 mm. Their contents appear to be unsegmented at the time of laying.

4. *Spiironoura falcata* (v. Linstow, 1906). (Fig. 86.)

Synonyms:—*Oxysoma falcatum* v. Linstow, 1906; *Falcaustra falcata* Lane, 1915; *Spiironoura falcatum* Yorke and Maplestone, 1926; ? *Oxysoma kachugæ* Stewart, 1914; *Falcaustra kachugæ* Baylis and Daubney, 1922; *Spiironoura kachugæ* Yorke and Maplestone, 1926.

Hosts:—*Geoemyda* [*Nicoria*] *trijuga* (intestine); Colombo, Ceylon (v. Linstow); locality not given (Lane). *Kachuga kachuga* [*K. lineata*] (intestine); Lucknow (Stewart).

v. Linstow gave a somewhat incomplete and in some respects inaccurate description of this species. Lane (1915, *b*) gave a fuller account of specimens from the same host, which in all probability belonged to the same species. The following description is taken mainly from the latter author.

The male measures 11.6–14 mm. in length and 0.55–0.6 mm. in maximum thickness, the female 14.1–17 mm. and 0.56–0.7 mm. respectively. The cuticular striations are fine ($2\ \mu$ apart). There are no lateral alæ. The head is slightly wider than the neck. The total length of the œsophagus is about 1.95 mm., the buccal cavity measuring about 0.08 mm., the pharynx 0.05 mm., the prebulbar swelling 0.16 mm. and the bulb 0.26 mm. The latter has a diameter of 0.3 mm. The cylindrical portion of the œsophagus measures 0.125 mm. in width. The nerve-ring is situated at 0.3 mm., the cervical papillæ at 1 mm., and the excretory pore at 1.3 mm., from the anterior end.

The tail of the male is about 0.8 mm. long. There is no preanal sucker-like organ. There are ten pairs of caudal papillæ and a median preanal papilla. The spicules measure

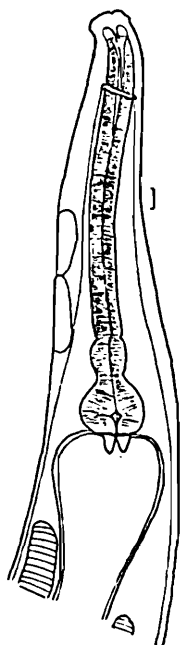

Fig. 86.—*Spiironoura falcata*. Anterior end of male; lateral view.
(After Lane.)

0.35–0.45 mm. in length and 0.07 mm. in maximum width. There is an accessory piece, which is granular in appearance and measures 0.1 mm. in length.

The tail of the female is 1.6 mm. long, and bears a pair of papillæ at 0.6–0.7 mm. from the tip. The vulva is situated at about 10 mm. from the anterior end of the body. The vagina runs forward from it for a distance of 0.8–0.9 mm., where it gives off the two directly opposed uterine branches. The eggs have a fairly thick shell measuring 0.14×0.09 mm. Their contents are separated from the shell by a space at one pole.

Stewart (1914, *a*) described, under the name of *Oxysoma kachugæ*, a single female specimen from *Kachuga lineata*,

which seems almost certainly to have been a small and immature example of *S. falcata*. The total length of the worm was 13.68 mm. The length of the tail is given in the table of measurements as .59 mm., but it is clear from the text, as Lane (1915, *b*) has pointed out, that this should have been 1.59 mm. Most of the other measurements are in very close agreement with those given above for *S. falcata*.

5. *Spiromoura brevispiculata* Baylis, 1935. (Fig. 87.)

Host :—*Rana hexadactyla* ; Colombo, Ceylon.

This form differs only in very small points from *S. falcata*, and the examination of further material may possibly show that the differences are not specific.

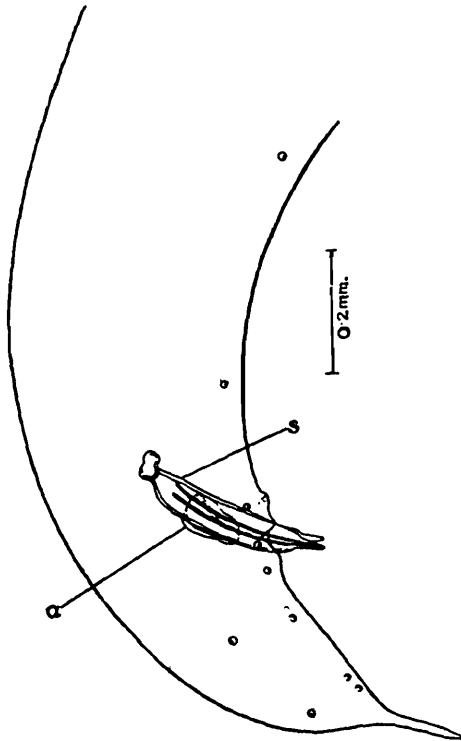

Fig. 87.—*Spiromoura brevispiculata*. Posterior end of male; lateral view. *a.*, accessory piece; *s.*, right spicule. (After Baylis.)

The male measures 11.6–13.5 mm. in length, the female 13.5–14.7 mm. In both sexes the maximum thickness varies between 0.5 and 0.7 mm. The cuticular striations are extremely fine. The head is slightly wider than the neck, and has a diameter of 0.13–0.15 mm. in the male and 0.14–0.16 mm. in the female. The length of the oesophagus, measured from the anterior extremity and including the posterior bulb, is about 1.7–1.9 mm. The combined length of the bulb and prebulbar swelling is 0.36–0.43 mm., and the width of the bulb 0.24–0.29 mm. The combined length of the buccal cavity and pharynx is 0.15–0.18 mm. The nerve-ring is

situated at 0.35–0.38 mm., the cervical papillæ at about 0.8–1 mm., and the excretory pore at about 0.95–1.25 mm., from the anterior extremity.

The tail, in both sexes, is conical and rapidly tapering in its anterior two-thirds or three-quarters. Distally it tapers more gradually, forming a stout terminal spike about 0.13–0.15 mm. long. In the male the tail measures 0.43–0.5 mm. in length. There appear to be normally ten pairs of papillæ and a flattened median precloacal papilla. Their usual arrangement is shown in fig. 87, but some variation occurs in the position of some of the postanal papillæ. The spicules measure 0.29–0.35 mm. in length. The accessory piece is apparently about 0.09–0.1 mm. long. There is no sucker-like organ.

The tail of the female measures 0.5–0.6 mm. in length, and bears a pair of lateral papillæ a little in front of the middle. The vulva is situated at about 5.5–6 mm. from the posterior end of the body, and the relatively short vagina runs anteriorly from it, at the same time crossing the body-cavity to the dorsal side. The eggs measure 0.12–0.146 × 0.068–0.08 mm. Their contents are unsegmented *in utero*.

6. *Spironoura stewarti* (Baylis and Daubney, 1922) Yorke and Maplestone, 1926. (Figs. 88 & 89.)

Synonym:—*Falcaustra stewarti* Baylis and Daubney, 1922.

Hosts:—*Kachuga smithi*; Ferozepore, Punjab. *Hardella thurgi*; Siripur, Saran, Bihar.

The original specimens from the two hosts mentioned differed somewhat in size and in certain minor characters, but the differences are not considered great enough to be of specific importance. In the material from *Kachuga smithi*, which was taken as typical, the male measures 17–19.8 mm. in length and 0.6–0.7 mm. in maximum thickness, the female 19–22.6 mm. and 0.65–0.75 mm. respectively. The cuticular striations are exceedingly fine. The head has a diameter of 0.19–0.21 mm., and is followed by a narrower neck. The total length of the œsophagus is 2.1–2.5 mm. The buccal cavity is shallow, measuring only 0.06 mm. in length. The pharynx is 0.09 mm. long. The prebulbar swelling and the bulb are not distinctly separated, and measure together 0.5–0.55 mm. in length. The width of the bulb is 0.3–0.32 mm. The nerve-ring is situated at 0.5–0.6 mm., the small but very prominent cervical papillæ at 1.3–1.37 mm., and the excretory pore at 1.6–1.85 mm., from the anterior end.

The tail of the male is 1.4–1.7 mm. long, and tapers to a slender point. There is no preanal sucker-like organ. There

Fig. 88.

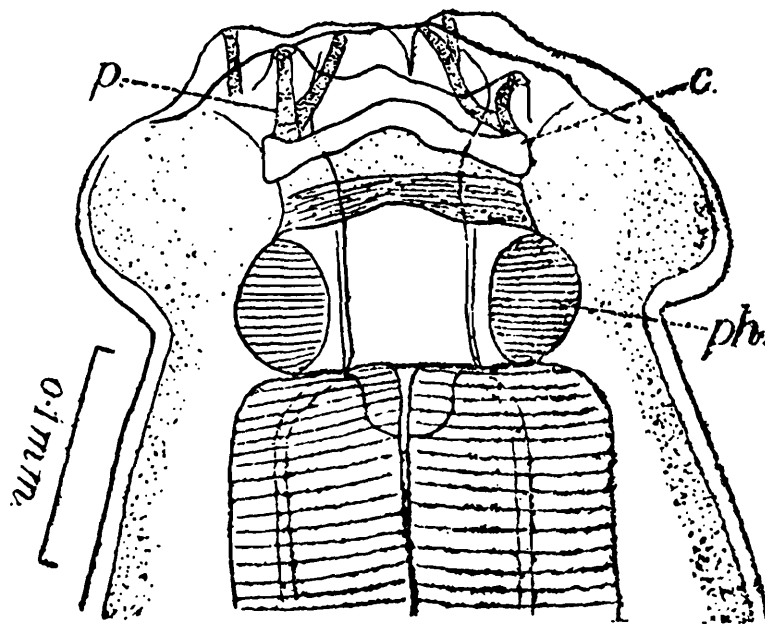

Fig. 89.

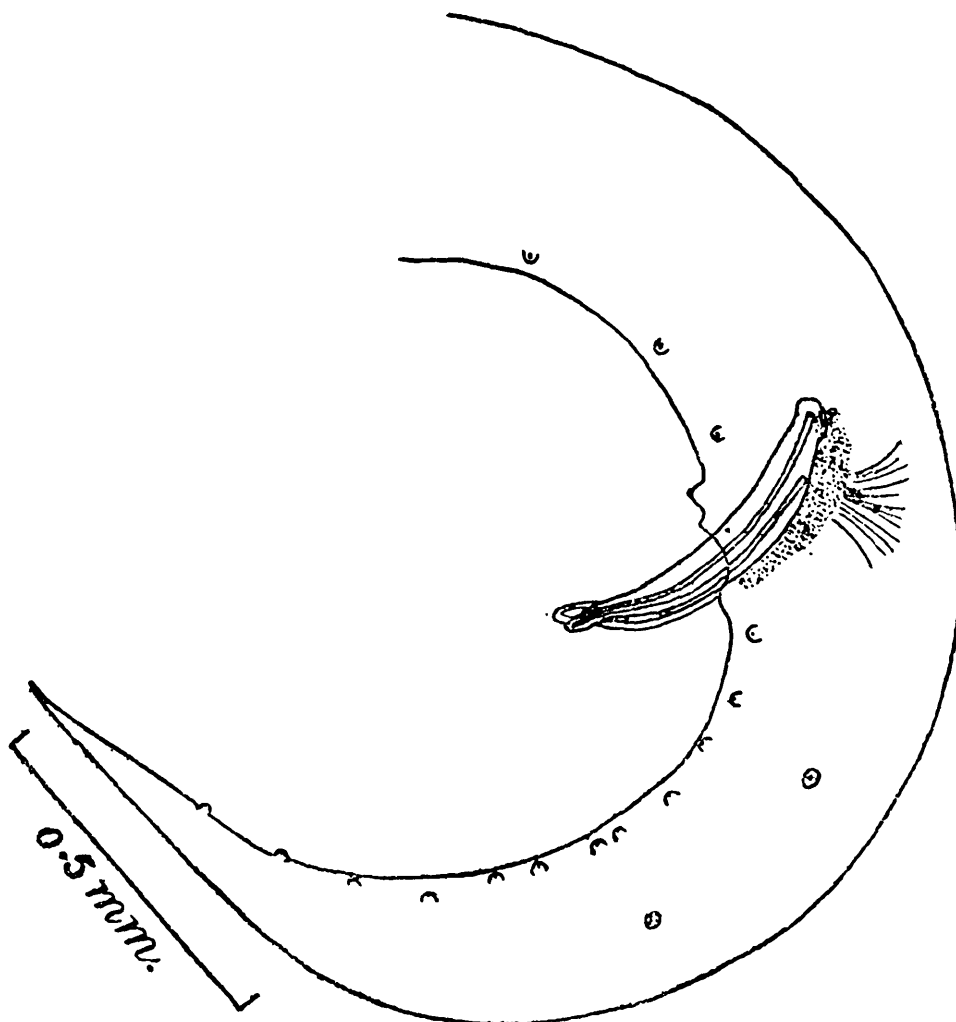

Fig. 88.—*Spironoura stewarti*. Anterior end of female; dorsal view.
 c., cuticular ring; p., forked pulp of papilla; ph., pharynx.
 (After Baylis and Daubney.)

Fig. 89. *Spironoura stewarti*. Posterior end of male; lateral view.
 (After Baylis and Daubney.)

are 16 to 18 pairs of caudal papillæ and the usual unpaired preanal papilla. Of the postanal papillæ two pairs are lateral, the rest subventral. Occasionally one or two of the anterior subventral pairs become adanal in position. The members of the more posterior pairs sometimes become displaced anteriorly or posteriorly, so as to disturb the symmetry of the paired arrangement. The spicules measure 0.5 mm. in length and 0.09 mm. in maximum width. The accessory piece is represented by a vaguely-defined mass of imperfectly-chitinized tissue.

The tail of the female is tapering and finely pointed, and measures 2.25–2.6 mm. in length. It bears a pair of papillæ at about 1.6 mm. from the tip. The vulva is situated at 7.75–10.3 mm. from the posterior end. The vagina is about 1.5 mm. long. The eggs measure about 0.15×0.105 mm., have shells 5 μ thick, and contain embryos when ready for laying.

The specimens from *Hardella thurigi* were somewhat stouter, having a maximum thickness of 0.8–0.9 mm. in the male and 0.8–1.05 mm. in the female. The head was also larger, having a diameter of 0.28–0.35 mm. The tail, in both sexes, was a little longer, and many of the other measurements were slightly greater.

7 *Spironoura onama* Karve, 1927

Host :—*Testudo emys* (rectum) ; Burma.

The male measures 8.28–8.5 mm. in length and 0.606 mm. in maximum thickness, the female 10.6–12 mm. and 0.687 mm. respectively. The cuticular striations are fine. The head is somewhat wider than the neck, and has a diameter of 0.143–0.15 mm. The buccal cavity is about 0.031–0.044 mm. long. The length of the œsophagus is about 1.6 mm. The pharynx measures about 0.063–0.066 mm. in length and 0.081–0.094 mm. in width. The prebulbar swelling is relatively small, having a diameter of 0.162–0.168 mm., and is sharply constricted off from the bulb. The latter is spherical, and has a diameter of 0.275–0.287 mm. The nerve-ring is situated at 0.375–0.387 mm., the very prominent cervical papillæ at 0.925 mm., and the excretory pore at 1.237–1.25 mm., from the anterior end.

The tail of the male appears, from Karve's figure, to be about 0.35 mm. long. There is a preanal sucker-like organ, situated at about 1.85 mm. from the posterior extremity. There are ten pairs of caudal papillæ and an unpaired preanal papilla. The spicules measure about 0.81 mm. in length and 0.068 mm. in maximum width. Their proximal ends are described as being surrounded by a chitinized and transversely

striated "sheath," measuring 0.144 mm. in length and lying between the accessory piece and the roots of the spicules. The accessory piece, which is said to be chitinized and well developed, but is not clearly indicated in the figure, measures 0.09–0.1 mm. in length.

The tail of the female is 1.112–1.343 mm. long, and bears a pair of papillæ at 0.762–0.825 mm. from the tip. The vulva is situated at 4.06–4.67 mm. from the posterior end. The eggs measure 0.137×0.087 mm.

4. Genus **ZANCLOPHORUS** Baylis and Daubney, 1922.

Head somewhat narrower than neck, surrounded by a slight cuticular collar at its base. Lips large, entire, flattened anteriorly, each carrying a pair of rather prominent papillæ and bordered internally by a cuticular fringe. Oral cavity with three separate, double, horseshoe-shaped chitinoid supports at its angles. Pharynx with wide lumen, lined with thickened cuticle. Œsophagus similar to that of *Spiironoura*. A single well-developed muscular preanal sucker present in the male. Spicules as in *Spiironoura*, but relatively much longer. A large, but incompletely chitinized, accessory piece present. Female organs as in *Spiironoura*. Adult worms in the stomach and intestine of land-tortoises.

Genotype:—*Zanclophorus annandalei* Baylis and Daubney, 1922.

Key to Species.

Preanal papillæ of male six pairs.
Preanal papillæ of male five pairs

annandalei, p. 174.
kempi, p. 177.

1. **Zanclophorus annandalei** Baylis and Daubney, 1922. (Figs. 90–93.)

Host:—*Testudo travancorica* (stomach); Cochin State Forests, Western Ghats.

The male measures 15.5–15.9 mm. in length, the female 15–17.4 mm. The maximum thickness is 0.85–1.1 mm. The cuticular striations are about 2 μ apart. The head has a diameter of 0.2–0.23 mm. The total length of the Œsophagus is 2.6–2.85 mm. The pharynx measures 0.14–0.15 mm. in length and 0.09 mm. in greatest diameter. The bulb, together with the prebulbar swelling, measures 0.6–0.65 mm. in length, and has a width of 0.4–0.44 mm. The nerve-ring is situated at 0.55–0.6 mm., the cervical papillæ at 1.5–1.74 mm., and the excretory pore at 2.2 mm., from the anterior end.

The tail of the male is 0.45–0.5 mm. long. The sucker is situated at a distance of about 1.5 mm. from the cloacal aperture. There are ten pairs of caudal papillæ and a median

Fig. 90.

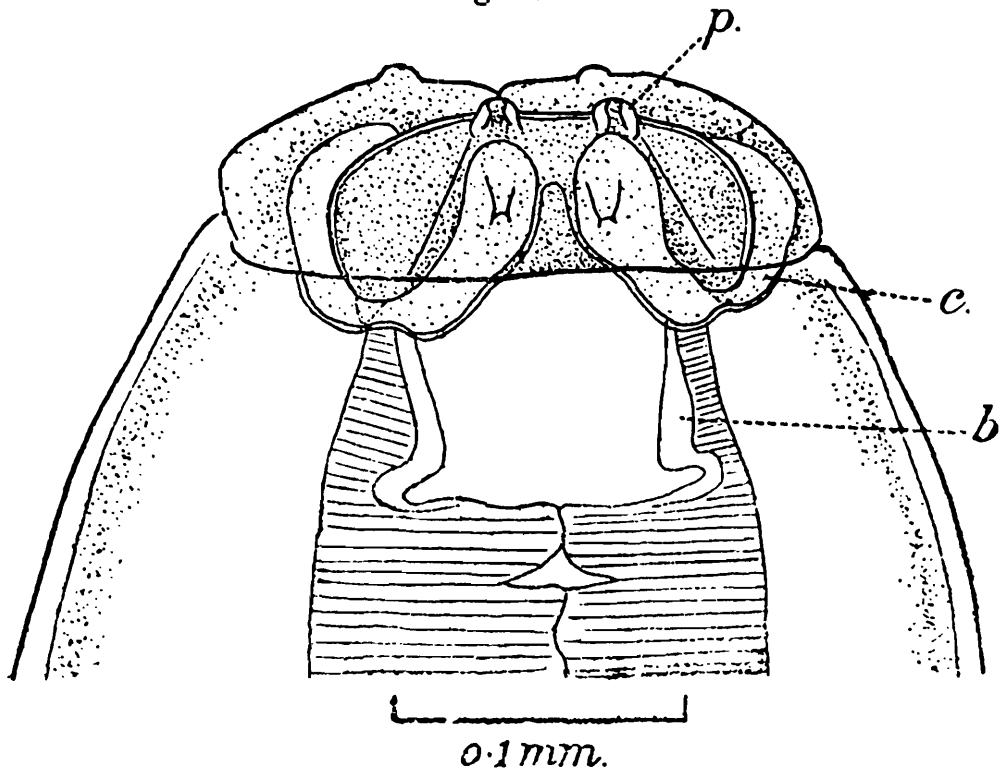

Fig. 91.

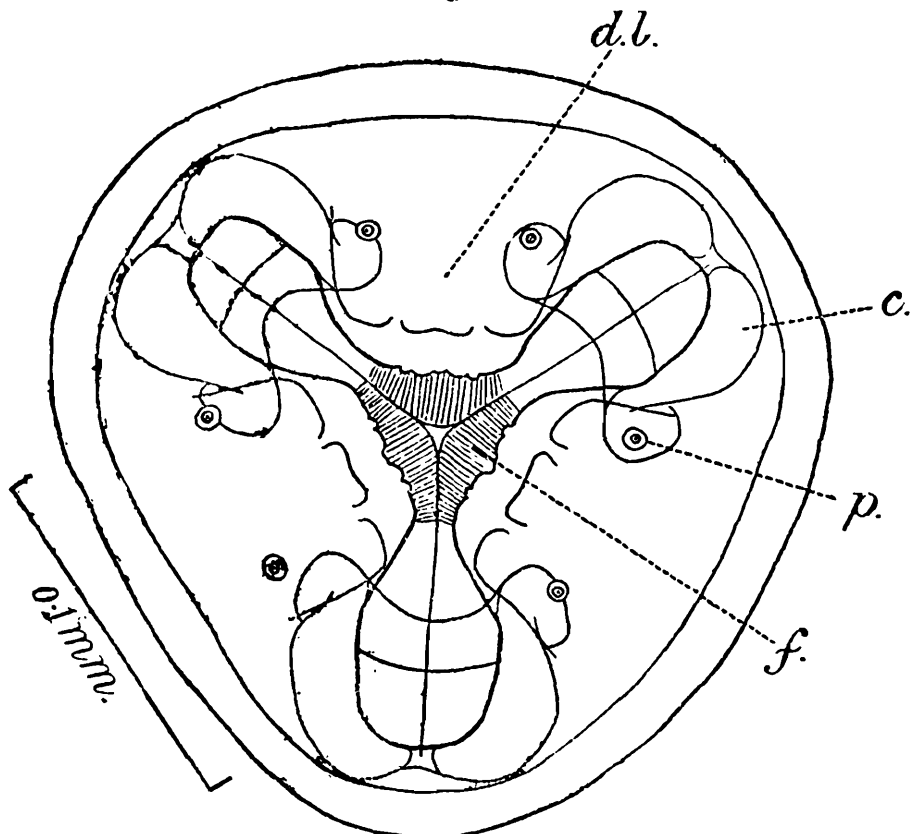

Fig. 90.—*Zanclophorus annandalei*. Anterior end of female; dorsal view. *b.*, lining of buccal cavity; *c.*, one of the three cuticular supports; *p.*, papilla. (After Baylis and Daubney.)

Fig. 91.—*Zanclophorus annandalei*. Anterior end, viewed *en face*. *c.*, one of the three cuticular supports; *d.l.*, dorsal lip; *f.*, cuticular fringe of lip; *p.*, papilla. (After Baylis and Daubney.)

precloacal papilla. Four pairs are postanal, two of them being subventral and two lateral, and six pairs are preanal. Of these, three pairs are close together near the cloaca, and three pairs, more widely separated, lie between these and the sucker. The spicules measure 2.2–2.3 mm. in length and 0.058 mm. in maximum width. The large accessory piece, which is only partially chitinized, is deeply cleft in front.

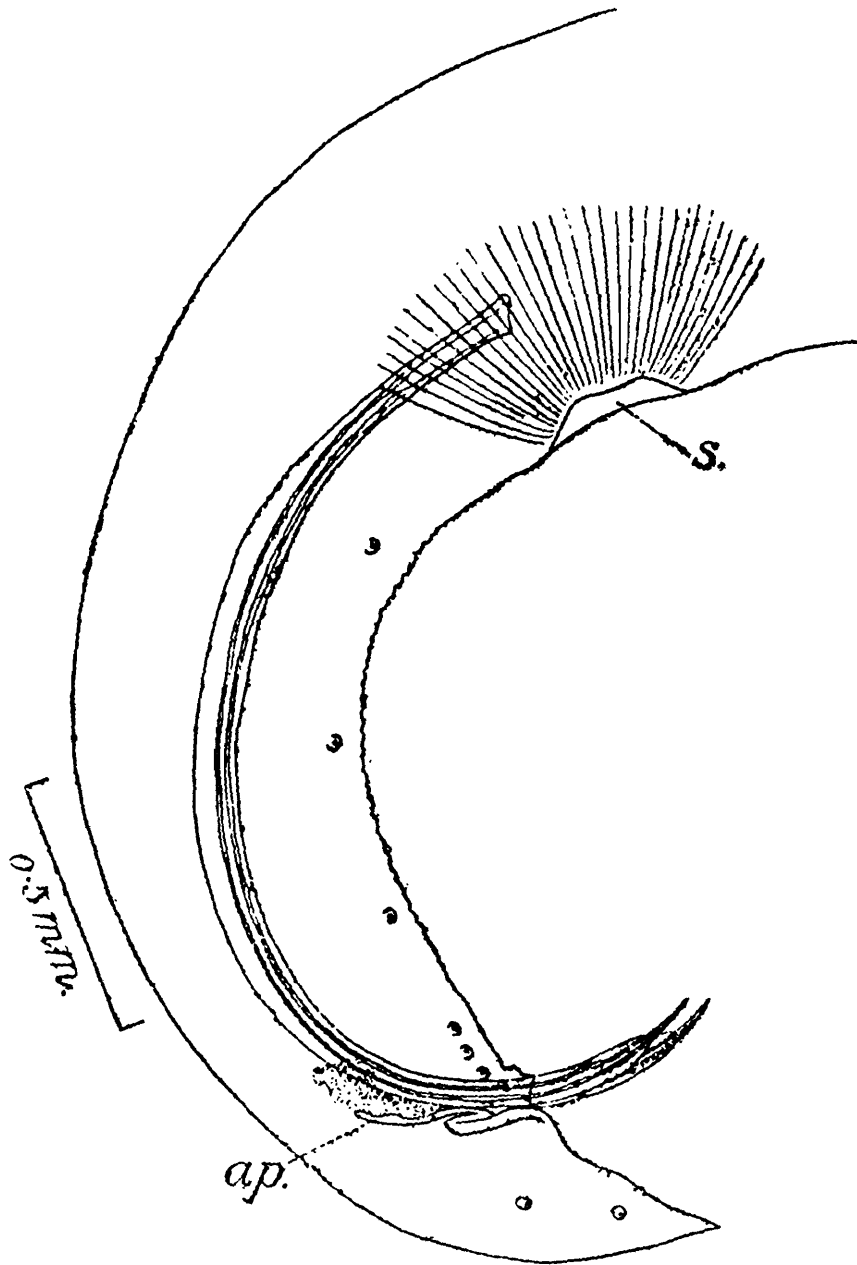

Fig. 92.—*Zanclophorus annandalei*. Posterior end of male; lateral view. *a.p.*, accessory piece; *s.*, sucker. (After Baylis and Daubney.)

The tail of the female is 0.7–0.75 mm. long. The vulva is situated at 5–5.5 mm. from the posterior end. The vagina runs forward for about 2 mm. before giving off the two directly opposed uterine branches. The eggs measure about 0.125×0.075 mm.

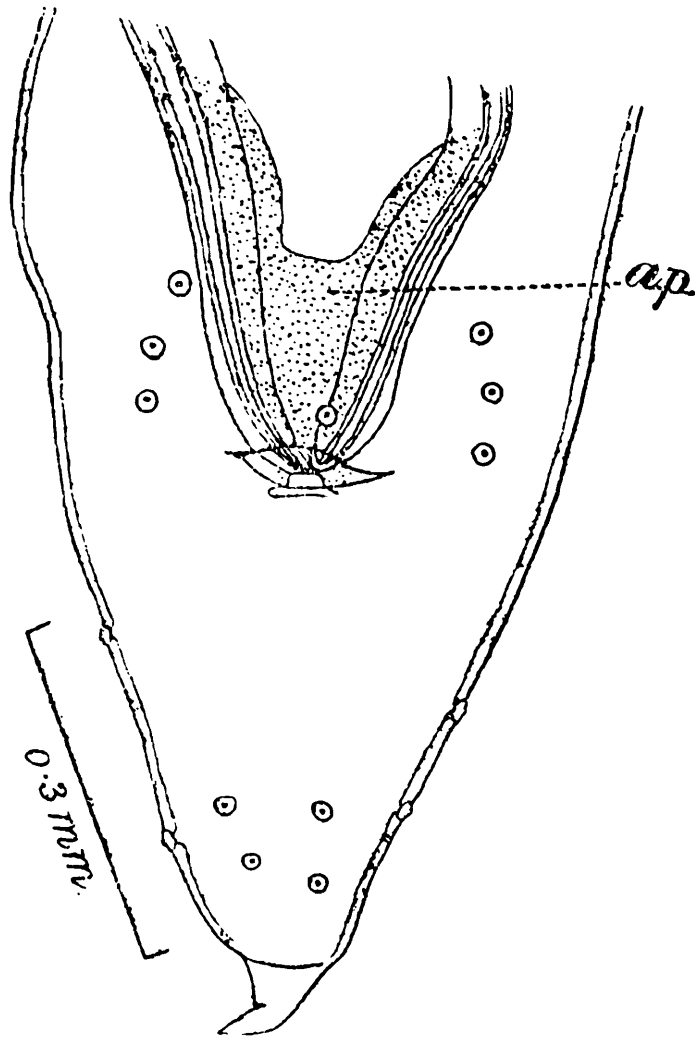

Fig. 93.—*Zanclophorus annandalei*. Posterior end of male; ventral view. *a.p.*, accessory piece. (After Baylis and Daubney.)

2. *Zanclophorus kempfi* Baylis and Daubney, 1922. (Fig. 94.)

Host:—*Testudo elongata* (intestine); Baradighi, Jalpaiguri, Bengal; and near Tura, foot of Garo Hills, Assam.

The male measures 10.9–12.8 mm. in length and 1–1.1 mm. in maximum thickness, the female 13.4–15.8 mm. and 1.2–1.4 mm. respectively. The cuticular striations are exceedingly fine. The diameter of the head is 0.22–0.24 mm. The total length of the œsophagus is 2.3–2.5 mm. The pharynx measures 0.13 mm. in length and 0.09–0.1 mm. in greatest diameter. The bulb, together with the prebulbar swelling, measures 0.45–0.6 mm. in length. Its width is 0.4–0.48 mm. The nerve-ring is situated at 0.52–0.58 mm., the cervical papillæ at 1.5–1.6 mm., and the excretory pore at 1.7–1.95 mm., from the anterior end.

The tail of the male is 0.45–0.55 mm. long. The sucker, which is deep and strongly muscular, is situated at a distance

of about 1.1 mm. from the cloacal aperture. There are nine pairs of caudal papillæ and the usual median precloacal papilla. The arrangement of the papillæ is the same as in *Z. annandalei*, except that one of the three pairs immediately in front of the cloaca is absent. The spicules measure 2.9 mm. in length and 0.1 mm. in width. The accessory piece is similar to that of *Z. annandalei*.

The tail of the female is bluntly conical and measures 0.55–0.8 mm. in length. The caudal papillæ are situated at

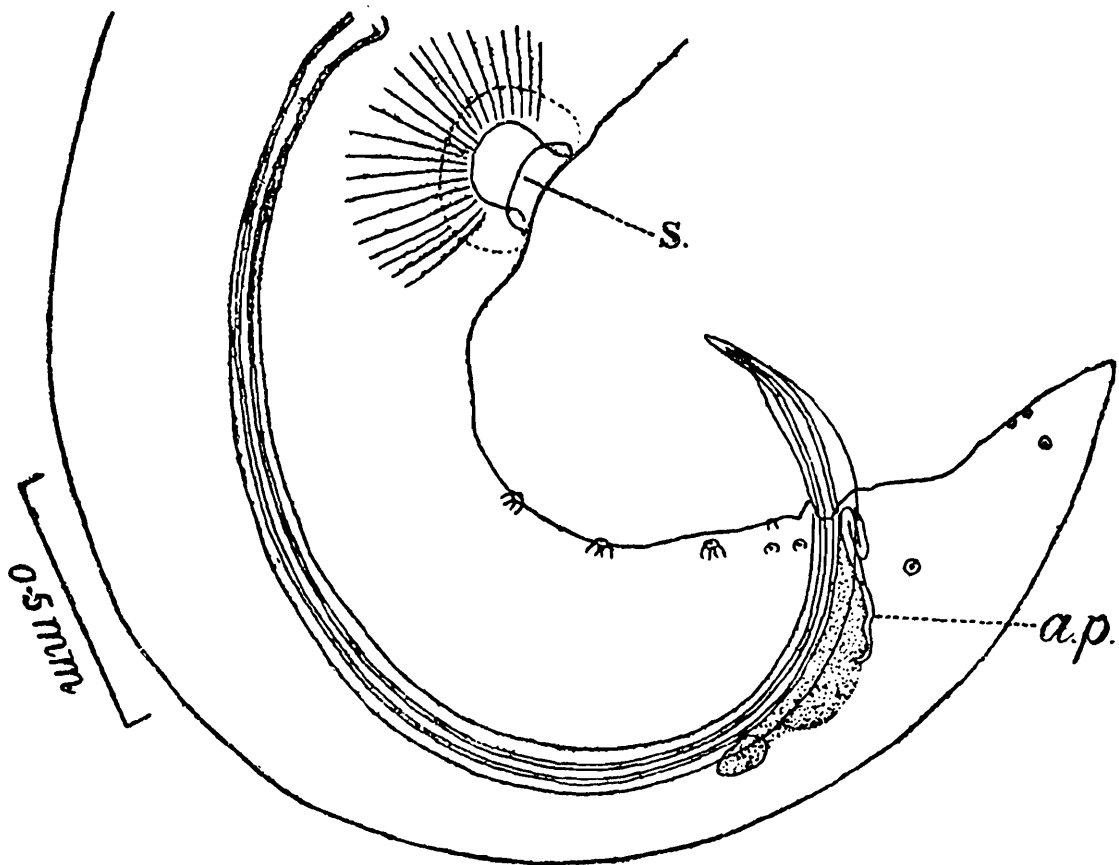

Fig. 94.—*Zanclophorus kempii*. Posterior end of male; lateral view. a.p., accessory piece; s., sucker. (After Baylis and Daubney.)

0.27 mm. from the tip. The vulva is situated at 4–4.8 mm. from the posterior end of the body. The vagina is narrow and about 2 mm. long, and runs forward from the vulva. The eggs are oblong-oval and measure $0.125\text{--}0.137 \times 0.075\text{--}0.085$ mm. Their contents are unsegmented *in utero*.

The following form is placed here because it appears possible that it may belong to the genus *Zanclophorus*, or at least be closely related to it. Parona's description is not very intelligible, and is in places self-contradictory, while the decimal point in many of his measurements is probably misplaced.

3. *Heterakis feæ* Parona, 1889.

Host:—*Testudo* sp. (intestine); Jadò village, Mt. Carin, district of the Asiuii Chebà, Burma.

According to Parona's description, the male measures 26 mm. in length, the female 28 mm. The maximum thickness is 1.5 mm. Body whitish, elongate, attenuated at each end, especially posteriorly. Dorsal lip larger, ventral lips with papillæ. Buccal aperture with raised folds, 0.021 mm. wide. Œsophagus 3 mm. long, expanding into a large, distinct bulb with two swellings, of which the upper is the smaller and has a transverse diameter of 0.03 mm. [? 0.3 mm.], the lower of 0.044 mm. [? 0.4 mm.]. There are two chitinous plates in the centre of the upper swelling.

Tail of male tapering, curved ventrally so as to form a complete circle, without terminal spike. Aperture of sheath of spicules [? cloaca] 0.049 mm. [? 0.49 mm.] from caudal end. Spicules "very long" (2 mm.), equal, curved. Papillæ small and numerous, 14 to 16 pairs preanal [12 pairs shown in figure], three pairs postanal [none shown in figure], and one pair, larger, lateral to cloacal aperture. Sucker oval, "with large chitinous ring," about 1.5 mm. from tip of tail.

Tail of female tapering and conical, without terminal spike. "Anal aperture at three quarters from tip of tail." Vulva at posterior third of body, "about 5 mm. from posterior end." Vagina 0.011 mm. [? 0.11 mm.] wide, directed anteriorly. Ovarian tubes extend anteriorly as far as the œsophageal bulb, and posteriorly nearly to the anus. Eggs oval, colourless, 0.0126 mm. [sic] long by 0.07 mm. wide. The shell is of remarkable thickness, with elevations and with pigment. In some eggs the embryo is well developed.

5. Genus **CRUZIA** Travassos, 1917

Synonym:—*Oxysoma* Schneider, 1866 (part).

Lips well developed, subtriangular. Lateral fields broad. Pharynx three-sided, with narrow lumen, strongly chitinized and containing three longitudinal series of teeth, which in the genotype are forwardly directed. In the genotype there are also at the base of the pharynx three large, blunt, tooth-like structures. Œsophagus with a large, spherical posterior bulb and a small prebulbar swelling. Intestine with an anterior cæcum. Ventral surface of preanal region in male rugose. Caudal muscles well developed, but not aggregated into a sucker-like organ. Caudal papillæ sessile. Spicules subequal, alate. A large, subtriangular accessory piece present. Tail of female tapering. Vulva slightly in front of the middle

of the body, not prominent. Eggs relatively large, with thick, rugose shell, containing embryos when laid. Adult worms in the large intestine of opossums, pigs and (?) lizards.

Genotype :—*Cruzia tentaculata* (Rudolphi, 1819).

1. *Cruzia orientalis* Maplestone, 1930. (Figs. 95 & 96.)

Host :—Domestic pig (cæcum and large intestine) ; Calcutta.

The worms measure 13–17·9 mm. in length. The dorsal lip has very prominent lateral angles. The ventro-lateral

Fig. 95.

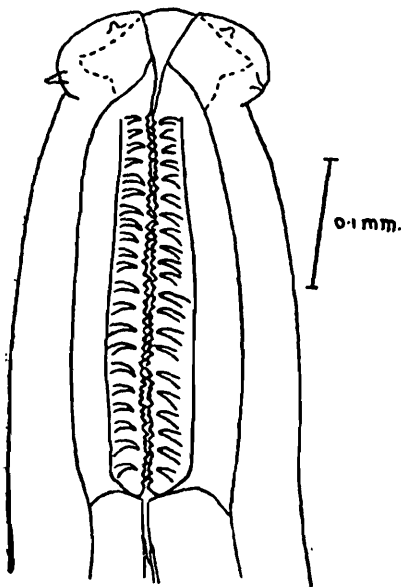

Fig. 96.

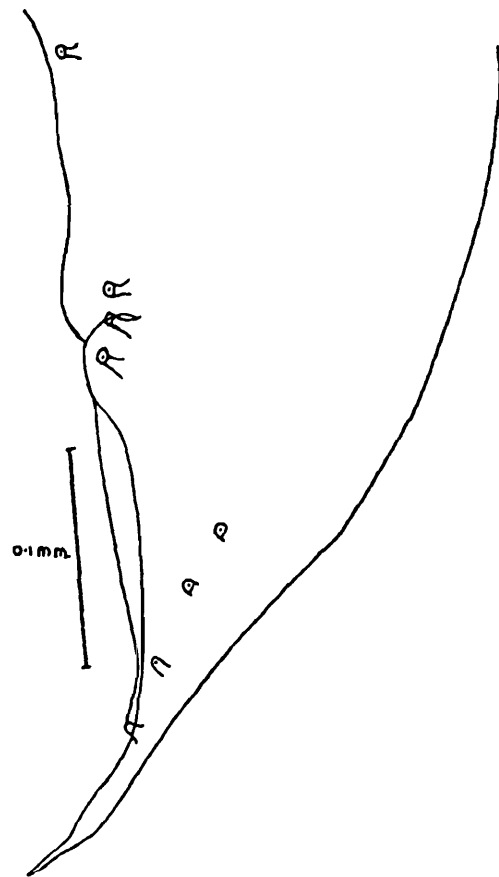

Fig. 95.—*Cruzia orientalis*. Anterior end; ventral view. (After Maplestone.)

Fig. 96.—*Cruzia orientalis*. Posterior end of male; lateral view. (After Maplestone.)

lips are marked off from the body by a deep groove. The pharynx is 0·24–0·32 mm. long, and is described as containing from 19 to 23 rows of teeth. This apparently means that each of the longitudinal rows contains 19 to 23 teeth, the rows, in Maplestone's sense, being transverse. All the teeth are of about the same size. The length of the œsophagus is given as 2·34–2·95 mm. It is not clear whether this includes the pharynx and bulb. The latter measures 0·28–0·38 mm. in diameter. The intestinal cæcum is 1·09–1·96 mm. long.

The tail of the male appears, from Maplestone's figure, to be about 0.25 mm. long. There are ten pairs of caudal papillæ, of which four are definitely postanal, three form an adanal group and three are more anterior. The spicules measure 0.86–1.03 mm. in length, and the accessory piece 0.18–0.22 mm.

The tail of the female is 0.69–0.71 mm. long. The eggs measure 0.12×0.056 –0.06 mm.

6. Genus **CISSOPHYLLUS** Railliet and Henry, 1912.

Mouth dorso-ventrally elongate, with complex lips. Dorsal lip trident-shaped, ventro-lateral lips armed with groups of lancet-like teeth. Œsophagus with a slightly differentiated anterior portion (? pharynx) and a posterior bulb. Male with a fusiform preanal sucker-like organ. Caudal papillæ small, sessile. Spicules subequal. An accessory piece present. Vulva in posterior third of body. Uterine branches parallel, running anteriorly. Eggs segmenting when laid. Adult worms in the intestine of land and freshwater tortoises.

Genotype :—*Cissophyllus laverani* Railliet and Henry, 1912.

1. **Cissophyllus laverani** Railliet and Henry, 1912. (Fig. 97.)

Host :—*Testudo emys* (intestine); locality not given by Railliet and Henry, but this tortoise occurs in Assam and Burma.

The male measures 25–31 mm. in length and 1.5–1.6 mm. in maximum thickness, the female 24–31 mm. and 1.6–1.8 mm. respectively. The cuticular striations on the greater part of the body are very fine (1.5μ apart), but in the head region the intervals between them increase to 6.5μ . The musculature is said to be polymyarian. The two lateral and four submedian cephalic papillæ all have double terminations. The Œsophagus measures 3.6–3.8 mm. in total length, and is composed of three portions of almost equal length. The first two portions are distinguished, according to Railliet and Henry (1912, *b*), by their degree of chitinization, the second being somewhat darker in colour than the first. The third portion, which is slightly thicker, ends in a globular bulb containing finely-folded chitinous plates.

The tail of the male is 0.65–0.7 mm. long. The sucker-like organ, which is not very highly developed, is situated at a distance of 2.3–2.5 mm. from the cloacal aperture. There are eleven pairs of caudal papillæ, of which six are preanal and five postanal. The spicules are approximately equal, and measure 1.675–2.05 mm. in length and 0.095–0.11 mm. in

width. The hollow accessory piece is 0.4 mm. long. Its width is 0.2 mm. in front and 0.16 mm. behind.

The tail of the female is 0.9 mm. long, and bears a pair of papillæ. The vulva is situated a little behind the posterior

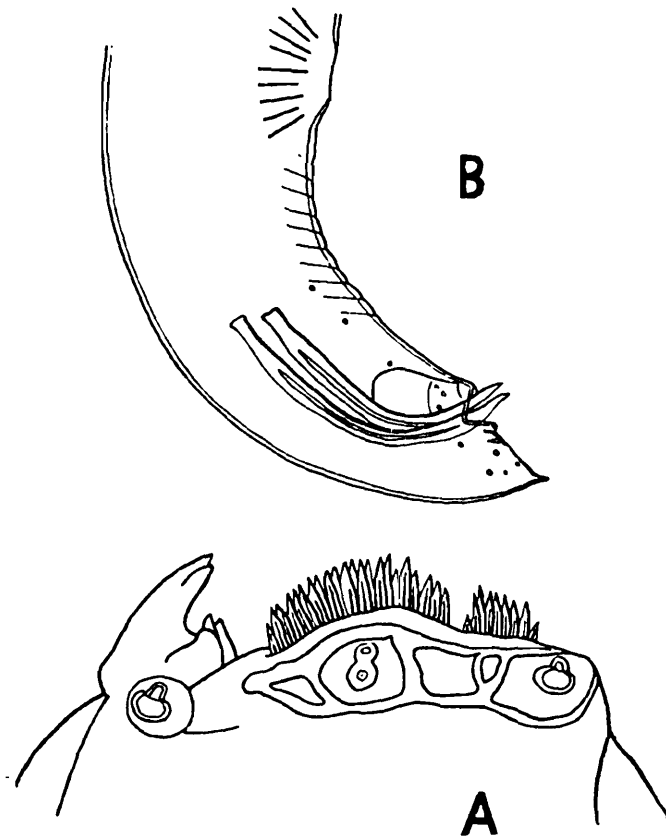

Fig. 97.—*Cissophyllus laverani*. A, head, lateral view; B, posterior end of male, lateral view. (After Railliet and Henry.)

third of the body. The eggs are oblong, with very thin shells measuring 0.11–0.117 × 0.059–0.062 mm. Their contents are in early stages of segmentation at the time of laying.

7 Genus **PROBSTMAYRIA** Ransom, 1907

Head truncate. Lips bilobed, the dorsal lip having two papillæ with long peduncles, the ventro-lateral lips each one such papilla. Pharynx tubular, composed of a small anterior portion without muscles and a longer, muscular posterior portion. Caudal end of male without sucker-like organ. Several pairs of small postanal papillæ present. Spicules short, subequal in genotype. Tail in both sexes long and tapering. Vulva at about the middle of the body. Viviparous (eggs few and large, hatching in uterus). Adult worms in the alimentary canal of mammals (colon of Equidæ, small intestine of Primates).

Genotype :—*Probstmayria vivipara* (Probstmayr, 1865).

1. *Probstmayria simiæ* Maplestone, 1931. (Figs. 98 & 99.)

Host :—Hoolock gibbon (*Hylobates hoolock*) (in mucus from upper part of small intestine); Zoological Gardens, Calcutta.

The male measures 1.5–1.6 mm. in length and 0.076 mm. in thickness, the female 1.6–1.8 mm. and 0.12–0.13 mm. respectively. The lips are about 0.01–0.012 mm. long. The pharynx measures 0.06–0.065 mm. in length and 0.015 mm. in diameter, and is finely striated. The œsophagus consists of two parts, the anterior cylindrical and measuring about 0.17 mm. in length and 0.015 mm. in diameter, the posterior

Fig. 98.

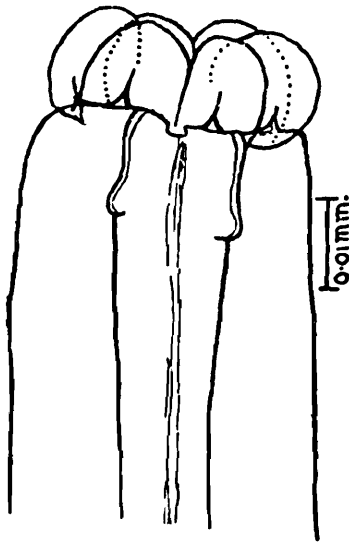

Fig. 99.

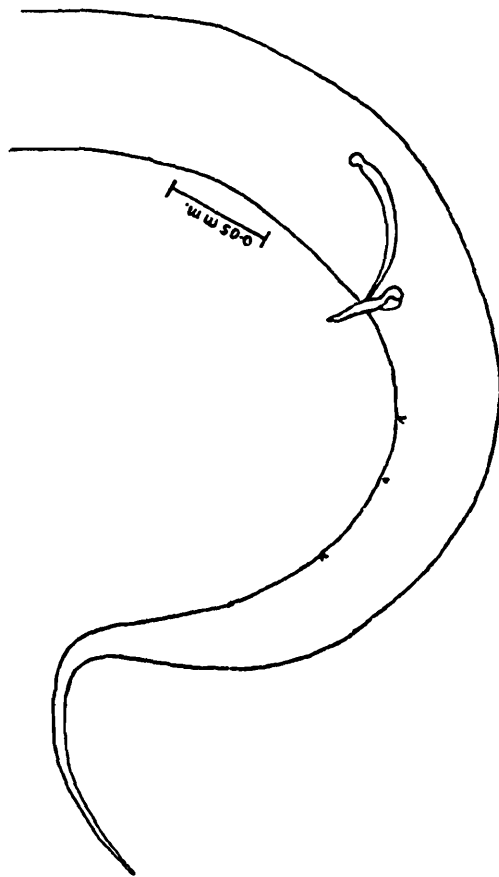

Fig. 98.—*Probstmayria simiæ*. Anterior end. (After Maplestone.)

Fig. 99.—*Probstmayria simiæ*. Posterior end of male; lateral view. (After Maplestone.)

flask-shaped, 0.11 mm. long and terminating in a spherical bulb 0.06 mm. in diameter. “The bulb is furnished with a powerful valvular apparatus. Under the oil immersion the cusps of this valve are seen to be covered with fine concentric ridges.” The nerve-ring is situated at 0.148 mm. from the anterior end. The excretory pore opens just in front of the œsophageal bulb, and leads into a relatively large globular vesicle.

The tail of the male is about 0.36 mm. long, and bears four pairs of postanal papillæ. “The spicules are unequal

and dissimilar. One is short, straight, and relatively thick, it is 0.04 mm. in length, the other is more delicate and curved like a sabre blade, it is 0.08 mm. in length. There is no gubernaculum."

The tail of the female is 0.45–0.5 mm. long. The vulva has prominent lips and is situated just in front of the middle of the body. The uterine branches are opposed. The embryos attain a length of 0.93 mm. and a thickness of 0.041 mm. before birth. "The embryos contain a well-developed œsophagus of the adult type, and they apparently reach maturity without any change in morphology, because all stages from embryos just escaped from the uterus and with no trace of genitalia up to fully mature specimens were encountered, and the only difference in the various stages was in their size."

4. Family OXYURIDÆ Cobbold, 1864.

Small or medium-sized parasitic forms. Musculature meromyarian. Mouth with simple, usually inconspicuous lips. No buccal capsule. Œsophagus usually with a pharynx and always with a distinct posterior bulb, containing a three-fold valvular apparatus. Reproductive organs of a relatively simple type. Ovaries short, producing relatively few and large eggs. Excretory pore at about the level of the œsophageal bulb or even behind it. Caudal end of mature female always elongate and tapering. Male almost always without a preanal sucker. The worms are oviparous. The life-history is direct, without an intermediate host.

Subfamily OXYURINÆ Hall, 1916.

Mouth with three or six lips. Male with a single spicule, which may be vestigial; or, rarely, without a spicule. An accessory piece usually absent. The caudal papillæ of the male are mainly in the vicinity of the cloaca.

Key to Genera.

- | | |
|--|---------------------|
| Parasites of reptiles | THELANDROS, p. 192. |
| Parasites of mammals | 1. |
| 1. Male with two or three large ventral bosses ;
parasites of rodents | SYPHACIA, p. 198. |
| Male without ventral bosses | 2. |
| 2. Parasites of the horse tribe | OXYURIS, p. 185. |
| Parasites of Primates | ENTEROBIUS, p. 188. |

1. Genus **OXYURIS** Rudolphi, 1803.

Synonym :—*Lepturis* Schlotthauber, 1860.

Lips not apparent. Cuticle of head not inflated. Mouth hexagonal. One pair of lateral and two pairs of large submedian cephalic papillæ present. Œsophagus relatively short, hourglass-shaped, with a short pharynx, containing numerous cuticular bristles in both sexes and three prominent teeth in the female. The narrow middle portion of the œsophagus passes gradually into the pyriform posterior bulb. Tail of male truncate, with alar expansions in front of and behind the cloaca, each supported by a pair of pedunculate papillæ. Two or three pairs of smaller caudal papillæ also present. A single spicule present. No accessory piece. Tail of female very long. Vulva towards the anterior end of the body but postœsophageal. The common trunk of the uterus extremely long, extending almost to the posterior end, and there dividing into two short branches which run parallel to each other in the anterior direction. Eggs elongate, with thick shells, flattened on one side and provided with an operculum at one pole. Their contents are unsegmented when laid. Adult worms in the large intestine of Equidæ.

Genotype :—*Oxyuris equi* (Schrank, 1788).

1. **Oxyuris equi** (Schrank, 1788) E. Blanchard, 1849.
(Figs. 100–102.)

Synonyms :—*Trichocephalus equi* Schrank, 1788; *Trichuris equi* Bruguière, 1791; *Mastigodes equi* Zeder, 1803; *Oxyuris curvula* Rudolphi, 1803; *Oxyuris mastigodes* Nitzsch, in Giebel, 1857; *Lepturis curvula* Schlotthauber, 1860; *Oxyuris mastigoides* Gough, 1908; ? *Oxyuris tenuicauda* v. Linstow, 1901.

Hosts :—This is a cosmopolitan parasite of the colon and cæcum of horses, donkeys, mules and zebras. In India and Burma it has been recorded fairly frequently, *e. g.* by Montgomery (1906), Gaiger (1910 and 1915), and Baylis and Daubney (1923, *b*).

The male measures 9–12 mm. (exceptionally as much as 16·6 mm.) in length and about 0·78 mm. in thickness, the female about 40–150 mm. and 1·5–2 mm. respectively. The variation in the length of the female is mainly due to the tail, which may vary from about half the total length to several times the length of the rest of the body. The lips are relatively large. A pair of low lateral and two pairs of stout submedian cephalic papillæ are present.

In the male the buccal cavity, which is three-sided, measures 0·068 mm. in length. The œsophagus is about 1·5–1·7 mm. long. Its anterior portion measures 0·29 mm. in thickness,

the cylindrical middle portion 0.15 mm. and the bulb 0.36 mm. The slender, sharply-pointed and needle-like spicule is 0.12–0.165 mm. long.

In the female the œsophagus measures about 2.7 mm. in total length. Its anterior portion measures 0.5 mm. in thickness, the middle portion 0.24 mm. and the bulb 0.55 mm.

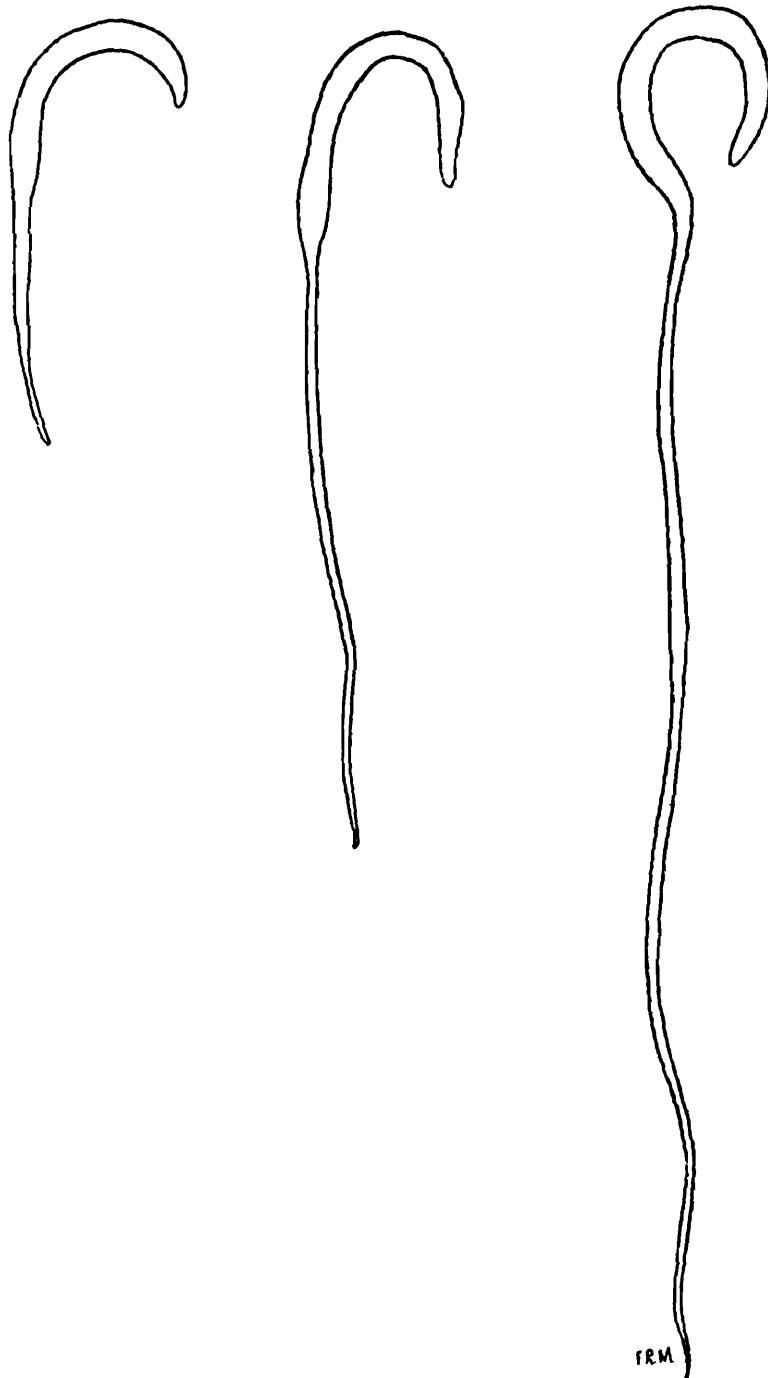

Fig. 100.—*Oxyuris equi*. Outlines of three females (natural size), to show variation in length of tail. (From Baylis, after Railliet.)

The nerve-ring is situated at about 0.4–0.5 mm. from the anterior end, and the vulva at 7–10 mm. from the same point. The eggs measure 0.074–0.099 × 0.038–0.045 mm.

Cameron (1925) gives the following summary of the life-history of this species :—

“ The females deposit their eggs on leaving the large intestine and reaching the exterior. The majority stop at the edge of the anus, being retained by their tail, and the eggs are ejected as the result of uterine peristalsis in a sticky mass

Fig. 101.

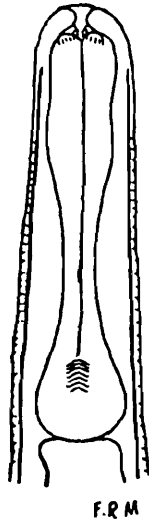

F.R.M

Fig. 102.

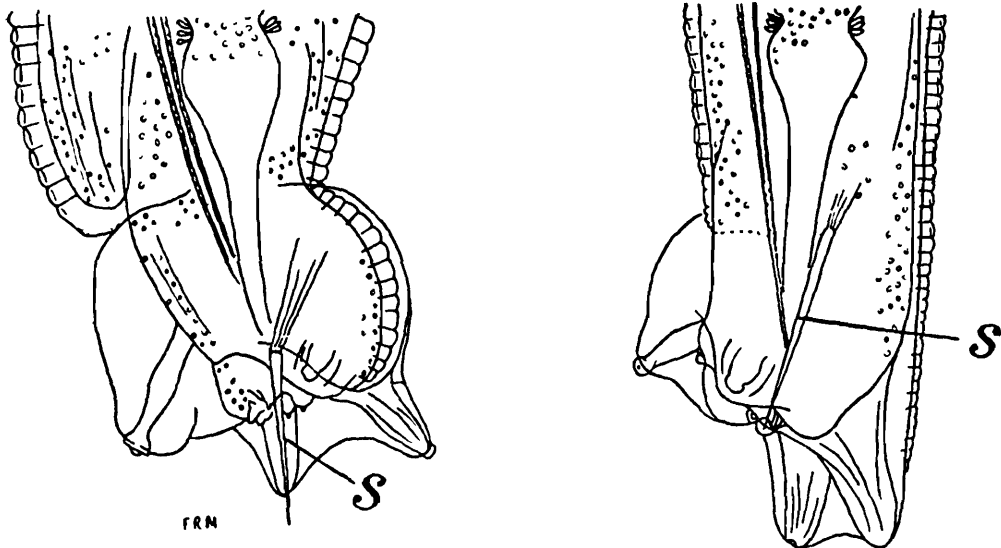

Fig. 101.—*Oxyuris equi*. Anterior end of female ; dorsal view. (From Baylis, after Yorke and Maplestone.)

Fig. 102.—*Oxyuris equi*. Two views of posterior end of male. s., spicule. (From Baylis, after Railliet.)

on to the perineum and inner surface of the tail. The female then dies and dries up. This viscous oviferous material causes intense pruritus in the peri-anal region with excoriation of the perineum and depilation of the tail, and the horse may become emaciated and even unmanageable as the result of the irritation. It is continually rubbing its hind quarters

against anything which presents itself, and so aids in the distribution of the ova. The eggs quickly develop on the warm skin, and within 48 hours—generally less—they contain an embryo. After 4–8 days, the eggs drop off from the skin and with the manure are further distributed. Water does not appear to be essential for the development of these eggs, but oxygen is necessary. The eggs on being swallowed hatch in the small intestine, and after moulting [the worms] settle down in the cæcum. Eggs cannot develop without first reaching the air, and this is an essential condition for infection.”

2. *Oxyuris poculum* v. Linstow, 1904.

Host:—Horse; Ceylon (“passed by ponies on Iranativu”).

Of this species the type-specimens, which were originally in the Colombo Museum, do not appear now to be available. Although it may be reasonably suspected that the species would prove, on re-examination, to be identical with *O. equi*, there are certain points in v. Linstow’s description which it is not easy to reconcile with the common form, and his account is therefore quoted here.

“This species is nearly related to *Oxyuris curvula*, Rud. [i. e. *O. equi*], having the same form as the latter; the mouth is hexagonal with two large lateral papillæ in contradistinction to the six papillæ of *O. curvula*; the œsophagus in the male occupies $\frac{1}{7.7}$ of the total length, terminating in a bulbus; the ducts of the three œsophageal glands lie quite anteriorly in the lumen of the œsophagus, and are cup-shaped with denticulate margin, whereas in *O. curvula* they are tubular.

“The male is 14.2 mm. long by 0.99 mm. in diameter; the cirrus is 0.44 mm. long, finely acuminate; the tail carries four papillæ, of which two lie at the posterior angles of the quadrangular portion of the body and two are placed ventrally. The six median papillæ of *O. curvula* are absent in the present species.

“The female has a long filamentous hind body, and attains a length of 65 mm. and a breadth of 2.57 mm.; the eggs have a double shell; the outer shell is perforated at one pole, the orifice being closed by a plug; the eggs measure 0.081 mm. by 0.047 mm., those of *O. curvula* being 0.099 mm. by 0.042 mm.”

2. Genus **ENTEROBIUS** Leach, in Baird, 1853.

Synonyms:—*Oxyurias* Stiles, in Stiles and Hassall, 1905; *Fusarella* Seurat, 1916; *Trypanoxyuris* Vevers, 1923.

Cuticle of anterior end inflated. Lips fairly distinct. Mouth triradiate. Narrow lateral alæ present. Cœsophagus club-

shaped, with distinct posterior bulb, separated from the rest by a narrow neck. Caudal end of male truncate, with alæ supported in front by a pair of pedunculate preanal papillæ, and behind by a pair at the extremity of the tail. Two or three pairs of sessile postanal papillæ also present. A single, relatively long spicule. No accessory piece. Vulva in the anterior half of the body. Common trunk of the uterus relatively short. Uterine branches parallel. Adult worms in the intestine of Primates.

Genotype :—*Enterobius vermicularis* (Linn., 1758).

1. ***Enterobius vermicularis*** (Linnæus, 1758) Leach, in Baird, 1853. (Figs. 103 & 104.)

Synonyms :—*Ascaris vermicularis* Linnæus, 1758 ; *Fusaria vermicularis* Zeder, 1803 ; *Oxyuris vermicularis* Bremser, 1819 ; *Oxyurias vermicularis* [Stiles, in Stiles and Hassall, 1905], Ward, 1907 ; *Oxyuris (Oxyurias) vermicularis* Stiles, 1907 ; *Fusarella vermicularis* Seurat, 1916 ; ? *Ascaris pollicaris* Linn., *vide* Baird, 1853.

Hosts :—This species is a common parasite of man (especially of children) in all parts of the globe. It has not been definitely established that it occurs in any other animal, though there are records of its alleged occurrence in dogs. A number of other species of *Enterobius* are known, all of which appear to be confined to the Primates. Moreover, so exceedingly common and widespread a human parasite as *E. vermicularis*, were it capable of infesting dogs, might be expected to be very common in them. Such records must, therefore, be regarded with great suspicion. The worms inhabit the small intestine, cæcum, appendix and colon.

E. vermicularis is doubtless as abundant in India as in most other parts of the world, though few data as to its frequency are available. Sweet (1929) mentions that out of 11,972 persons in the State of Mysore, whose stools were examined for the eggs of parasitic worms, only 2·6 per cent. were found to be infested with this species, a percentage much lower than for hookworms, *Ascaris* or *Trichuris*. But, as this author remarks, the diagnosis of *E. vermicularis* by means of the microscopical examination of fæcal specimens “ is largely a matter of the chance occurrence of ova, and incidence figures are probably misleading.”

The male measures 2–5 mm. in length and 0·1–0·2 mm. in maximum thickness, the female 8–13 mm. and 0·3–0·6 mm. respectively. The narrow lateral alæ begin near the head and extend almost to the posterior end. The lips are retractile. The dorsal lip is larger than the ventro-lateral lips and carries two large papillæ, while each ventro-lateral lip has a large

lateral and a small subventral papilla. The cephalic cuticular swelling has a length of about 0.1–0.15 mm. and a width of 0.1–0.11 mm. in the male, and a length of about 0.2 mm. and a width of about 0.17 mm. in the female. The total length of the œsophagus is 0.54–0.6 mm. in the male and 0.9–0.93 mm. in the female. The diameter of the bulb is 0.09–0.11 mm. in the male and about 0.16–0.17 mm. in the female. The nerve-ring is situated just behind the cephalic swelling, and the excretory pore at about the level of the œsophageal bulb, or just behind it.

The posterior end of the male is curved ventrally. There are five pairs of caudal papillæ. A large anterior pair and

Fig. 103.

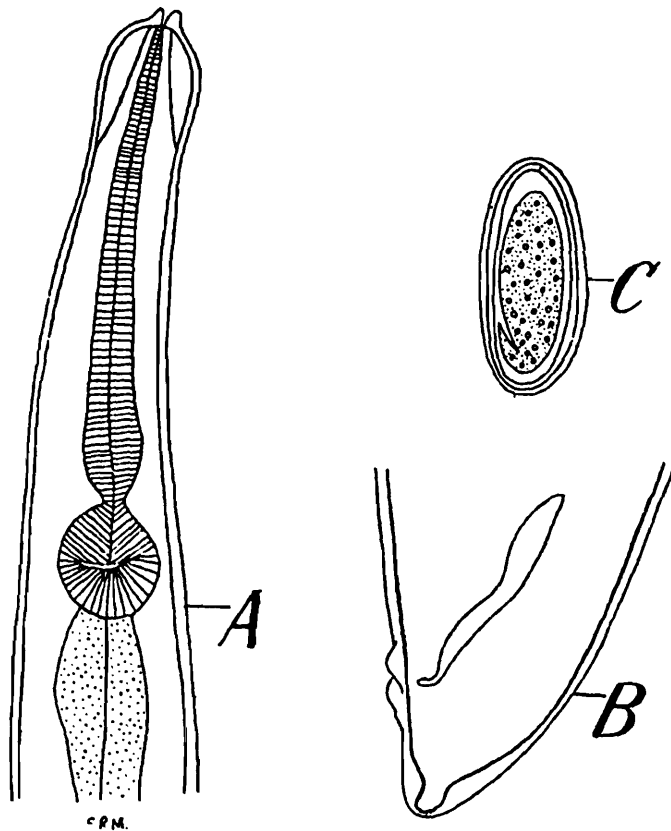

Fig. 103.—*Enterobius vermicularis*. A, anterior end, ventral view; B, posterior end of male, lateral view; C, egg. (From Baylis, after Yorke and Maplestone.)

Fig. 104.—*Enterobius vermicularis*. Spicule of male; lateral view. r., retractor muscle. (After Baylis.)

Fig. 104.



a posterior pair support the alæ. Between these two pairs there are three pairs of smaller subventral papillæ, of which the anterior is adanal and the posterior much more slender than the others. The spicule is relatively stout, and has a slender, slightly recurved tip, somewhat suggesting a blunt crochet-hook in shape. Its total length is about 0.125–0.13 mm., including a solid, club-shaped basal portion and a tubular distal portion, the latter being 0.07–0.08 mm. long.

The tail of the female is long and tapering, and occupies from about one-fifth to one-third of the total length. The vulva is situated at about the anterior third of the body. From this a short vagina runs posteriorly. The common trunk of the uterus is wide, and gives off two opposed uterine branches. The posterior of these runs straight back, while the anterior runs forward for only a short distance, then turns posteriorly. In gravid females the branches of the uterus occupy almost the whole of the body-cavity between the posterior end of the œsophagus and the anus, and sometimes extend beyond the latter into the tail. The eggs measure $0.05-0.06 \times 0.025-0.032$ mm., and are slightly flattened on one side.

When laid, the eggs contain a tadpole-shaped embryo. Under favourable conditions of warmth and moisture, such as they find in the perineal region of the host, they reach the infective stage in a few hours. The gravid female worms, which wander down to the anus and frequently escape from it (thereby causing intense irritation, particularly at night), frequently burst, or are ruptured through the efforts of the host to relieve the irritation by scratching. The eggs are then scattered in great numbers, and reinfection by means of soiled fingers is of very frequent occurrence. If swallowed, the eggs hatch in the duodenum of the host, and the worms reach maturity in the small intestine in about fourteen days.

2. *Enterobius anthropithecii* (Gedoelst, 1916).

Synonym :—*Oxyuris anthropithecii* Gedoelst, 1916.

Hosts :—This species was originally recorded from the chimpanzee (*Pan satyrus*) in the Belgian Congo. Baylis and Daubney (1922) have doubtfully referred to it some specimens from a black-headed lemur (probably *Lemur brunneus*) in the Zoological Gardens, Calcutta.

The male is unknown. The female measures 4–5.5 mm. in length and 0.325–0.36 mm. in maximum thickness. The cephalic cuticular swelling is 0.12 mm. wide and 0.08–0.095 mm. long, and is clearly marked off behind by a groove. The œsophagus occupies $1/5.75$ of the total length. Its anterior portion increases in diameter from about 0.04 mm. to a maximum of 0.072 mm. at the posterior swelling. The bulb has a diameter of 0.12 mm., and the “neck” separating it from the rest of the œsophagus measures 0.01 mm. in length and 0.032 mm. in width. The nerve-ring is situated at the anterior fifth of the œsophagus, and the excretory pore at the level of the junction of the œsophagus and intestine.

The tail is 1.4–1.5 mm. long. The vulva divides the total length of the body in the proportion of 1 : 2.35 or 1 : 2.85.

The anterior branch of the uterus turns posteriorly after running forward for a short distance, and both branches terminate anteriorly. The eggs are asymmetrical and measure 0.07×0.032 mm.

3. Genus **THELANDROS** Wedl, 1862.

Synonym :—*Parapharyngodon* Chatterji, 1933.

Mouth with three bilobed lips. Lateral fields each formed of a single row of very large cells with stellate nuclei. Lateral alæ present in male in some species, sometimes extending posteriorly as far as the cloaca. Œsophagus with a very short pharynx and a posterior bulb. Tail of male ends in a dorsal process. Three pairs of caudal papillæ usually present, one of which is situated on the ventral surface of the caudal process. A single spicule, sharply pointed. No accessory piece. Vulva usually a little behind the middle of the body. Uterine branches parallel. Eggs oval, not containing embryos when laid. Adult worms in the alimentary canal of lizards and tortoises.

Genotype :—*Thelandros alatus* Wedl, 1862.

Key to Species.

Parasite of <i>Hemidactylus</i>	<i>hemidactylus</i> , p. 196.
Parasite of <i>Calotes</i>	<i>maplestoni</i> , p. 195.
Parasites of <i>Uromastix</i>	1.
1. Posterior end of male retractile within a cuticular sheath.	2.
Posterior end of male without cuticular sheath.	3.
2. Spicule of male 0.08–0.09 mm. long.	<i>micruris</i> , p. 192.
Spicule of male 0.03–0.06 mm. long	<i>baylisi</i> , p. 194.
3. Male without lateral alæ except in caudal region; spicule about 0.03–0.04 mm. long.	<i>taylori</i> , p. 194.
Male with lateral alæ throughout greater part of body; spicule about 0.09–0.1 mm. long.	<i>kasauli</i> , p. 195.

1. **Thelandros micruris** Rauther, 1918. (Fig. 105.)

Synonym :—*Thelandros alatus* Thapar, 1925, *nec* Wedl, 1862.

Host :—*Uromastix hardwickii*; locality not given. This lizard occurs in India, and the specimens recorded from it and described by Thapar (1925) as *T. alatus* Wedl agree rather with *T. micruris*. *T. alatus* is a larger form occurring in North African species of *Uromastix*.

In Rauther's description, as may be inferred from the scale of magnification of the figures and from other internal evidence, the measurements of total length and thickness should be multiplied by 10. This gives the length of the male as 2.7 mm. and that of the female as 5.3 mm., while the maximum thickness of the male is 0.25 mm. and that of the female

0.5 mm. (Thapar gives these measurements as 3.5, 5.75, 0.22 and 0.25 mm. respectively). The œsophagus is slender and occupies in the male $\frac{2}{9}$, in the female $\frac{2}{11}$, of the total length. Its length, therefore, is 0.6 mm. in the male and about 0.96 mm. in the female (Thapar gives 0.62 and 0.82 mm.) The excretory pore is slightly prominent. In the female it is situated close behind the œsophageal bulb, dividing the body in the proportion of 1:4, and in the male more posteriorly, dividing the body in the proportion of 2:3. (According to Thapar, the pore is far behind the bulb in both sexes, and lies at 1.19 mm. (male) or 1 mm. (female) from the anterior end).

The cuticle of the posterior end in the male is inflated, especially ventrally, so as to form a prepuce-like fold. The cloacal aperture is situated on a conical process, and overhung by two short, fringed processes. At the level of the cloaca

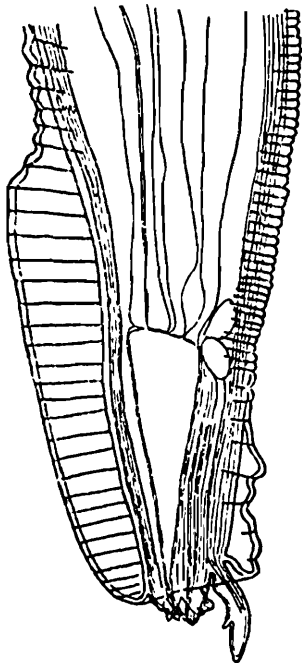

Fig. 105.—*Thelandros micruris*. Posterior end of male; lateral view. (After Rauther.)

on each side there is one single papilla and a more dorsally situated double papilla. The caudal appendage also bears a pair of very prominent papillæ. According to Thapar, the spicule is needle-shaped and measures 0.08–0.09 mm. in length.

The tail of the female measures $\frac{1}{14}$ of the total length (0.37 mm., according to Thapar). The vulva is slightly behind the middle of the body and is rather prominent, with an overhanging anterior lip. The ovaries are confined to the region anterior to the vulva. The eggs measure 0.1×0.05 mm. (According to Thapar they measure 0.14×0.08 mm., and are flattened at one pole. Chatterji (1935) gives their dimensions as about 0.07×0.047 mm.)

2. *Thelandros baylisi* Chatterji, 1935.

Host :—*Uromastix hardwickii* ; locality not given.

The male measures 2.5–3.7 mm. in length and 0.175–0.22 mm. in maximum thickness, the female 3.8–6.3 mm. and 0.3–0.66 mm. respectively. The cuticle is comparatively coarsely striated, and forms broad annulations in the posterior portion of the male. The œsophagus, including the bulb, measures 0.65–0.8 mm. in length in the male and 1–1.62 mm. in the female. The bulb has a diameter of about 0.098 mm. in the male. The nerve-ring, in the female, is situated at about 0.16–0.22 mm. from the anterior end. The excretory pore is behind the œsophageal bulb.

As in *T. micruris*, the posterior end of the male is thickened and the tail may be enclosed in a prepuce-like sheath of cuticle. The tail is constricted at the level of the cloaca, and its anterior portion bears a pair of small lateral alæ. The anterior lip of the cloacal aperture is fringed, its posterior lip conical and directed posteriorly. Of the two pairs of preanal papillæ the posterior is the larger. The postanal pair is situated at the base of the tail-spike. The spicule measures 0.03–0.06 mm. in length.

The tail of the female is 0.234–0.37 mm. long. The vulva is situated considerably behind the middle of the body, at 1.26–2.2 mm. from the posterior end. Its anterior lip is prominent. The ovarian coils are "close to the level of the vulva." The eggs measure 0.08–0.098 × 0.05–0.06 mm.

3. *Thelandros taylori* Chatterji, 1935.

Host :—*Uromastix hardwickii* ; locality not given.

The male measures 2–2.5 mm. in length and 0.15–0.22 mm. in maximum thickness, the female 2.96–4 mm. and 0.21–0.4 mm. respectively. Lateral alæ are absent, except in the caudal region of the male. The cuticular striations are at intervals of 7–12 μ in the male and 12–15 μ in the female. The œsophagus measures, including the bulb, 0.62–0.84 mm. in the male and 1–1.5 mm. in the female. The nerve-ring is situated at 0.098–0.13 mm. from the anterior end in the male, and at 0.14–0.2 mm. in the female. The excretory pore is behind the œsophageal bulb.

The tail of the male is 0.05–0.078 mm. long. It is suddenly constricted at the level of the cloacal aperture, and forms a dorsally-directed process with lateral alæ extending for more than half its length. Of the two pairs of preanal papillæ the posterior is the larger. The postanal pair is situated at the base of the tail-spike. The anterior lip of the cloacal aperture is fringed ; the posterior forms a long, posteriorly-

directed, conical process. The spicule measures 0.035–0.045 mm. in length.

The tail of the female is finely pointed and 0.108–0.156 mm. long. The vulva is situated at a distance of rather less than 0.5 mm. from the anus, and has a prominent anterior lip. The vagina is 0.08–0.12 mm. long. The coils of the ovaries are “on each side of the œsophageal bulb.” The eggs measure 0.08–0.095 × 0.047–0.065 mm.

4. *Thelandros kasauli* Chatterji, 1935.

Host :—*Uromastix hardwickii*; locality not given.

Of this form Chatterji had only two males when drawing up his description. These were in poor condition, and one of them appeared to be immature. The mature male measured 2.32 mm. in length and 0.44 mm. in maximum thickness. The females measured 3.35–7 mm. and 0.33–0.98 mm. respectively. The male has a pair of lateral alæ, originating at 0.236 mm. from the anterior end. These are narrow anteriorly, but gradually widen to about 0.04 mm. towards the posterior end of the body. The cuticular striations are at intervals of 15–30 μ in the male. The œsophagus measures 0.67 mm. in length in the male, 0.8–1.15 mm. in the female. In the former the bulb measures 0.118 × 0.137 mm., in the latter 0.138–0.195 × 0.156–0.234 mm. The nerve-ring is situated at about 0.14 mm. from the anterior end in the male, and at 0.09–0.14 mm. in the female. The excretory pore is behind the œsophageal bulb.

The male appears to be without caudal alæ. The two anterior pairs of papillæ are of about equal size. The posterior pair is situated at about the anterior third of the caudal appendage. The anterior lip of the cloacal aperture is simple, with projections only at the angles. The posterior lip is a posteriorly-directed conical process. The spicule is 0.114 mm. long.

The tail of the female is composed of an anterior blunt portion and a slender terminal spike. These measure in length 0.058–0.158 mm. and 0.078–0.11 mm. respectively. The vulva is situated a little behind the middle of the body, at 1.54–3.22 mm. from the posterior end. Its lips are more prominent in young than in old specimens. The vagina is 0.156–0.4 mm. long.

5. *Thelandros maplestoni* (Chatterji, 1933).

Synonyms :—*Oxyuris acanthura* v. Linstow, 1904, *nec* Molin, 1859; *Parapharyngodon maplestoni* Chatterji, 1933.

Host :—*Calotes versicolor* (intestine and rectum); Rangoon, Burma (Chatterji); Colombo, Ceylon (v. Linstow).

There can be little doubt that the form briefly described by v. Linstow (1904) is identical with that recently and more fully described by Chatterji. In any case there appears to be no justification for the erection of the genus *Parapharyngodon*, whose characters are the same as those of *Thelandros*. The type-specimens of v. Linstow's species should be in the Colombo Museum, but have apparently been lost or destroyed, and the writer has not succeeded in obtaining them for re-examination.

According to Chatterji, the male measures 1.98–2.6 mm. in length and 0.22 mm. in maximum thickness, the female 3–5.2 mm. and 0.36–0.45 mm. respectively. (According to v. Linstow, the male is 2.29 mm. long and 0.37 mm. thick, the female 5.84 mm. long and 0.55 mm. thick). The cuticle is coarsely and deeply ringed. The length of the œsophagus, including the bulb, is 0.45–0.54 mm. in the male, 0.83–1.03 mm. in the female. The diameter of the bulb is 0.09–0.11 mm. in the male and 0.15–0.198 mm. in the female. The nerve-ring is situated at about 0.11 mm. from the anterior end in the male, and at 0.13–0.152 mm. in the female. The excretory pore, in the female, is at about 1.35 mm. from the anterior end.

The caudal end of the male is curved ventrally, and the cloacal aperture is situated on a conical prominence at the base of which there are two pairs of lateral papillæ, while a third pair of papillæ is situated on the caudal process. The spicule measures 0.076–0.09 mm. in length (according to v. Linstow, 0.065 mm.)

The tail of the female is 0.3–0.4 mm. long, and its tip is curved dorsally. The vulva, which has slightly prominent lips, is situated approximately in the middle of the body, but its position is rather variable. The vagina runs posteriorly for a distance of about 0.34 mm. The ovarian tubes form coils in front of the œsophageal bulb. The eggs measure 0.08–0.091 × 0.042–0.05 mm.

6. *Thelandros hemidactylus* Patwardhan, 1935.

Host :—*Hemidactylus flaviviridis* (intestine); Nagpur, Central Provinces.

The male measures 2.8–3 mm. in length and 0.24–0.28 mm. in maximum thickness, the female 6.1–6.4 mm. and 0.7–0.76 mm. respectively. The cuticular striations are at intervals of 31–37 μ . Lateral alæ are absent. The mouth is surrounded by three bilobed lips, each lobe bearing a small papilla. The length of the œsophagus, including the bulb, is 0.57–0.62 mm. in the male and 1.09–1.1 mm. in the female. The diameter of the bulb is 0.1 mm. in the male and 0.2 mm. in the female. The lumen of the œsophagus is widened at its anterior end into

a small funnel, at the entrance to which there are three small teeth. The nerve-ring is situated at 0.07–0.075 mm. from the anterior end in the male, and at 0.13–0.14 mm. in the female. The excretory pore is behind the œsophageal bulb, at 0.75 mm. from the anterior end in the male, and 1.62 mm. in the female.

The caudal end of the male is curved ventrally, but the tail is produced into a dorsally-directed process 0.079 mm. long. There are no caudal alæ. The anterior lip of the cloacal aperture is not fringed. The posterior lip forms a prominent conical process. There are four pairs of papillæ, one pair large, lateral and situated at the level of the posterior cloacal lip, and three pairs subventrally situated, one in front of the cloacal aperture, one behind its posterior lip and one on the caudal process at about its anterior third. The spicule is stout and measures 0.051–0.056 mm. in length.

The tail of the female is stated to be only 0.079 mm. long, but appears from the figure given to be over 0.5 mm. long. It is slightly curved dorsally and ends in a sharp spike. The vulva has prominent lips and is situated at about the middle of the body (at 3.2 mm. from the anterior end). The ovarian tubes form a mass of coils round the œsophagus in front of the bulb. The eggs are flattened on one side and measure 0.081–0.094 × 0.041 mm.

7 “*Oxyuris*” *megaloon* v. Linstow, 1906.

Host :—*Hemidactylus leschenaulti* (intestine); Mamadu, Ceylon.

Of this species v. Linstow gives only a very brief description. Through the kindness of the Director of the Colombo Museum, the writer has been enabled to examine the type-specimens. These consist of three females, in rather poor condition. They agree very closely with the female of *Thelandros hemidactylus* Patwardhan, and it appears not improbable that the species may be identical, but in the absence of males of v. Linstow's species this question must be left open.

The length of v. Linstow's specimens is roughly 5–7 mm., and the maximum thickness (specimens somewhat flattened) about 0.9–1.1 mm. The head is very small, having a diameter of a little over 0.05 mm. It apparently consists of three bilobed lips, each lobe bearing a papilla. The head is only about one-third as wide as the immediately succeeding portion of the neck, into which it is partially retracted. The transverse striations of the cuticle are coarse and very conspicuous, the intervals between them measuring up to 40 μ .

The œsophagus is about 1.3 mm. long, including the posterior bulb, which measures about 0.2 mm. in length and 0.26 mm. in width. The anterior portion of the œsophagus is slender,

its diameter increasing gradually from about 0.055 mm. anteriorly to 0.08 or 0.09 mm. near the posterior end. It is joined to the bulb by a somewhat narrower neck. The intestine is extremely wide (about twice the width of the œsophageal bulb) at the point of junction with the œsophagus, but behind this initial swelling it becomes rapidly reduced in diameter.

The tail is conical, and does not show a sudden narrowing behind the anus, though it tapers more rapidly in its anterior than in its posterior half. Its length is about 0.45–0.55 mm. The cuticle of the tail is much thickened. The terminal portion curves slightly dorsally, and the tip is bluntly pointed. The vulva is situated somewhat in front of the middle of the body. The vagina runs posteriorly from it. Owing to the condition of the specimens and the great numbers of eggs in the uterus, it has not been possible to make out the precise arrangement of the genital tubes. The uterine coils extend anteriorly as far as the junction of the œsophagus and intestine, and posteriorly beyond the anus into the basal portion of the tail. The ovarian tubes extend anteriorly to about the middle of the œsophagus, forming a mass of coils round it in front of the bulb. The eggs measure about 0.088×0.045 mm. Their outline, as seen in optical section, is almost straight on one side and very convex on the other. The shell shows fine vertical striations.

4. Genus **SYPHACIA** Seurat, 1916.

Lips distinct. Buccal capsule absent. Œsophagus with a short pharynx, a prebulbar swelling and a distinct posterior bulb. In the male there are on the ventral surface of the body, in front of the cloacal aperture, two or three large median bosses. Tail of male narrows rather suddenly behind the cloacal aperture and is continued as a tapering filament. Two pairs of sessile preanal or adanal papillæ present, and a pair of prominent postanal papillæ at the base of the caudal filament. A single relatively long spicule and an accessory piece present. Tail of female tapering and pointed. Vulva in the anterior region of the body but postœsophageal. Common trunk of uterus relatively long. Uterine branches parallel, not extending posteriorly as far as the anus. Adult worms parasitic in the large intestine of rodents.

Genotype :—*Syphacia obvelata* (Rudolphi, 1802).

1. **Syphacia sciuri** Mirza and Singh, 1934.

Host :—Palm-squirrel (*Sciurus palmarum*); locality not mentioned.

The male measures 1.3 mm. in length and 0.08 mm. in thickness, the female 2.46–3.24 mm. and 0.19–0.23 mm. respectively. Small lateral cervical alæ are present. In the male there is also a pair of lateral alæ extending from behind the œsophageal bulb nearly to the level of the cloacal aperture. The œsophagus (presumably in the female) measures, including the bulb, 0.24 mm. in length.

The male has two ventral bosses, and is also described as having a dorsal boss behind the posterior of these. The spicule is 0.07 mm. long. "The gubernaculum is directed transversely."

The vulva is situated at a distance of 0.61 mm. from the anterior end. The eggs measure 0.11 × 0.04 mm.

2. *Syphacia* spp.

The writer has examined specimens belonging to this genus from the house-mouse (*Mus musculus* [*M. dubius*]) from Colombo, Ceylon, and from the black rat (*Rattus rattus*) from Lyallpur, Punjab. These appear to represent different species. Those from the former host may be *S. obvelata* (Rudolphi, 1802), but in view of the confusion at present existing between this species and *S. stroma* (v. Linstow, 1884) it seems wise not to attempt a specific determination.

S. stroma had long been regarded by most authorities as identical with *S. obvelata*, but Morgan (1932) has pointed out certain differences between the males, and given a new description of *S. stroma*. Unfortunately he gives no description of the female of *S. obvelata*, and the descriptions given by Dujardin (1845), v. Linstow (1884), Hall (1916), Seurat (1916) and Vogel (1925), all purporting to deal with *S. obvelata*, are probably based, at least in part, on specimens of *S. stroma*. No Indian records of either species have been found in the literature.

The specimens from *Mus musculus* have the following principal measurements:—Length, male, about 1.3 mm.; female, 2.7*–4.4 mm. Maximum thickness (under slight pressure), male, 0.13 mm.; female, 0.14–0.26 mm. Cuticular striations at intervals of 6–8 μ . Length of œsophagus (including the bulb), male, 0.22–0.24 mm.; female, 0.29–0.35 mm. Width of bulb, male, 0.055–0.06 mm.; female, 0.085–0.1 mm. Nerve-ring about 0.08 mm. from anterior end in male, 0.12 mm. in female. Excretory pore 0.28 mm. from anterior end in male, 0.4–0.47 mm. in female. Tail of male about 0.09 mm. long, spicule about 0.09 mm. and accessory piece about

* Females of the smallest size given had already been fertilized, but were without eggs.

0.032 mm. Tail of female 0.33–0.46 mm. long. Vulva 0.58–0.71 mm. from anterior end. Eggs 0.12–0.13 × 0.036–0.04 mm.

In the males the tail resembles that of *S. obvelata* rather than that of *S. stroma*, as described and figured by Morgan. The typical three ventral cuticular "bosses" are present, the posterior being situated at about 0.25 mm. from the cloacal aperture.

The specimens from *Rattus rattus* consisted of three females only, of which the following are the principal measurements:—Length 2.3–2.8 mm.; maximum thickness 0.18–0.21 mm.; length of œsophagus (including the bulb) 0.25–0.28 mm.; width of bulb 0.06–0.08 mm.; nerve-ring about 0.08 mm. and vulva 0.6–0.68 mm. from anterior end; length of tail about 0.4–0.5 mm.; eggs about 0.07 × 0.03 mm.

The eggs of this form are much shorter and more oval than those of "*S. obvelata*" or *S. stroma*, and it seems probable that it is specifically distinct.

Subfamily COSMOCERCINÆ Railliet, 1916.

Lips apparent or obscure. Male with two equal or subequal spicules and usually an accessory piece.

Of the two genera of this subfamily to be considered here, *Oxysomatium* is parasitic in amphibians and reptiles, *Syphaciella* in birds.

1. Genus **OXYSOMATIUM** Railliet and Henry, 1916.

Synonyms:—*Oxysoma* Schneider, 1866 (part); *Aplectana* of Yorke and Maplestone, 1926 (*nec* Railliet and Henry, 1916) (part); ? *Oxysomoides* Walton, 1927.

Lips small, sometimes not apparent. Œsophagus with a short pharynx and a posterior bulb. Caudal end of male tapering and pointed, with fairly numerous sessile preanal and postanal papillæ. Spicules equal, relatively long. A small, canoe-shaped accessory piece present. Vulva at about the middle of the body or somewhat behind it. Eggs contain embryos when laid (some species viviparous). Adult worms in the alimentary canal of amphibians and reptiles.

Genotype:—*Oxysomatium brevicaudatum* (Zeder, 1800) (= *O. longespiculum* Railliet and Henry, 1916).

1. *Oxysomatium macintoshii* (Stewart, 1914) Karve, 1927
(Fig. 106.)

Synonyms:—*Oxysoma macintoshii* Stewart, 1914; *Oxysomoides macintoshii* Walton, 1927.

Hosts:—This species is abundant in the rectum of frogs and toads—*Bufo stomaticus*, Lucknow (Stewart); *Bufo*

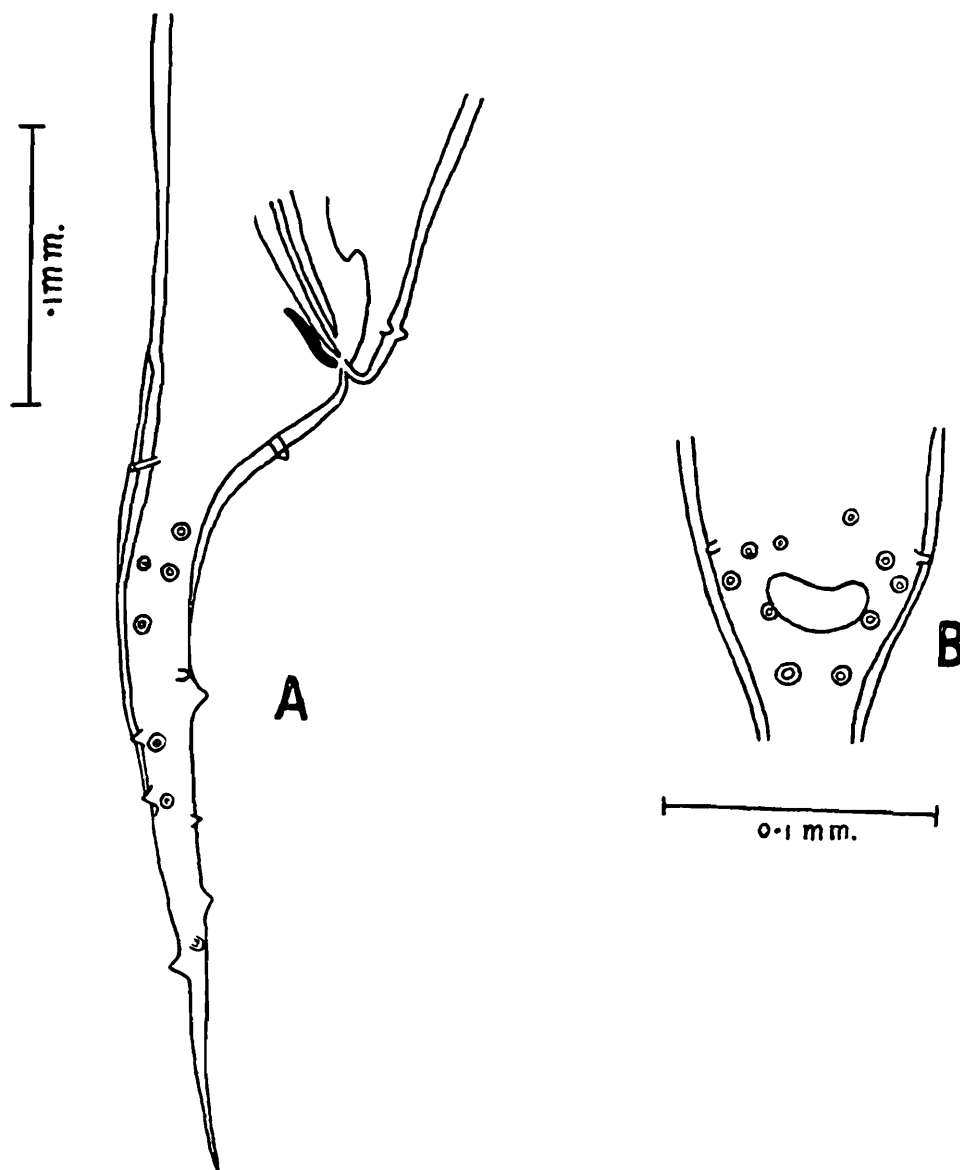

Fig. 106.—*Oxysomatium macintoshii*. A, posterior end of male, lateral view; B, cloacal region of male, ventral view. (After Karve.)

melanostictus, India and Burma (Karve); *Rana tigrina*, Lucknow (Stewart), India and Burma (Karve). *O. macintoshii* also occurs in Africa, having been recorded from *Nectophrynoides vivipara* in Tanganyika Territory and from *Bufo* spp. (subsequently determined as *B. viridis*

and *B. mauritanicus*) in the southern Sahara region and Niger valley.

This form has been fully redescribed by Karve (1927), whose account of it is followed here. The male measures 2–2.47 mm. in length and about 0.26 mm. in maximum thickness, the female 3–6 mm. and about 0.1–0.34 mm. respectively. The head is retractile. Lateral alæ extend throughout the greater part of the body. The total length of the œsophagus, including the bulb, is about 0.34–0.35 mm. in the male and 0.43–0.56 mm. in the female. The pharynx is 0.016–0.019 mm. long in the male and about 0.024 mm. in the female. At its entrance there are three tooth-like structures. The œsophageal bulb is subglobular and has a diameter of about 0.059–0.075 mm. in the male and 0.062–0.11 mm. in the female. The nerve-ring is situated at 0.24–0.38 mm., and the excretory pore at 0.28–0.5 mm., from the anterior extremity. The excretory pore is a conspicuous aperture with a diameter of 0.024–0.04 mm., and is surrounded by a crown of rod-like structures about 0.01 mm. long.

The tail of the male measures 0.26–0.3 mm. in length. There are 18 pairs of postanal papillæ, of which eight are subdorsal and ten subventral. The preanal papillæ number nine pairs, of which three, with the two most anterior pairs of postanal papillæ, form a subventral group surrounding the cloacal aperture, while six form a sublateral row on each side of the body. The spicules measure about 0.24 mm. in length. The accessory piece is 0.0224–0.032 mm. long.

The tail of the female is 0.35–0.41 mm. long, narrows rapidly behind the anus and ends in a tapering filament. It bears two pairs of papillæ. The vulva is situated at about the middle of the body. The vagina runs anteriorly from it for a short distance, then turns posteriorly and, at a point about 0.5 mm. behind the vulva, gives off the two opposed uterine branches. The eggs, according to Karve, "are large and irregular, and measure $0.3-0.337 \times 0.187-0.225$ mm. The worm is viviparous and deposits on an average two larvæ every fifteen minutes in normal salt solution."

2. Genus **SYPHACIELLA** Mönnig, 1923.

Mouth with three distinct bilobed lips. Cuticle of head inflated. Cervical alæ present. Œsophagus with a slight prebulbar swelling and a large posterior bulb. Male with wide caudal alæ, beyond which the tail extends as a terminal spike. About four pairs of small, sessile caudal papillæ present, all of which are near the cloacal aperture. Spicules subequal. An accessory piece present. Vulva anterior, postœsophageal, surrounded by a prominent cuticular swelling. Common

trunk of uterus extends posteriorly almost to the level of the anus. Uterine branches parallel. Eggs with a thick, striated shell, operculate at one pole. Adult worms in the alimentary canal of birds.

Genotype :—*Syphaciella capensis* Mönnig, 1923.

1. *Syphaciella indica* Maplestone, 1931. (Fig. 107.)

Host :—Sand-grouse (*Pterocles exustus*) (intestine); Zoological Gardens, Calcutta.

The male measures 3.4 mm. in length and about 0.29 mm. in maximum thickness, the female 5.5–6.6 mm. and 0.38–0.4 mm. respectively. The cephalic inflation measures, in

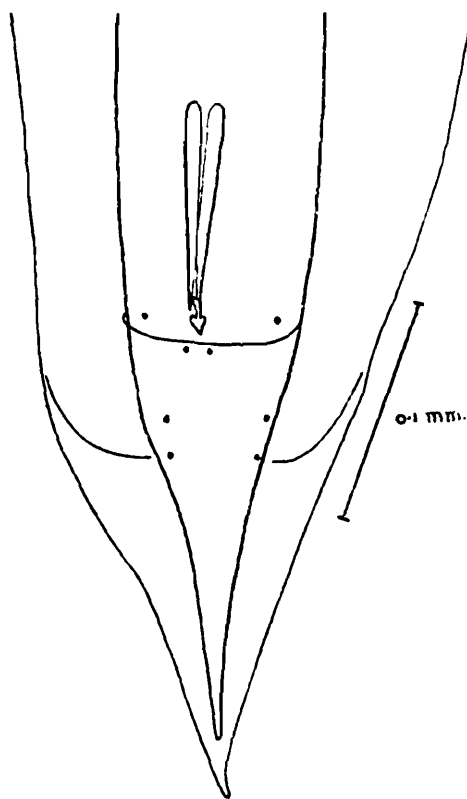

Fig. 107.—*Syphaciella indica*. Posterior end of male; ventral view. (After Maplestone.)

the female, 0.168–0.184 mm. in length. Lateral alæ are present throughout the body, extending, in the male, beyond the tip of the tail. The dorsal lip bears on its inner surface two finely-pointed structures which project anteriorly. Externally the dorsal lip bears two papillæ, each of the ventro-lateral lips one papilla. The œsophagus is slender, and measures in total length 0.49–0.51 mm. in the male and about 0.67 mm. in the female. The bulb is relatively very large.

The male has four pairs of very small caudal papillæ. The spicules measure 0.084 mm. in length, the accessory piece 0.037 mm. “The spicules are delicate and straight, their

proximal ends are rounded, from which they taper to end in fine points. The gubernaculum is more heavily chitinized, and in lateral view it is seen to be a slightly curved structure, which tapers from base to tip in a similar manner to the spicules."

The tail of the female is about 1 mm. long and ends in a long, fine point. The vulva is situated at about 1.4 mm. from the anterior end. "The eggs are oval and thick-shelled, appearing slightly thicker on one side than on the other. The shell is very finely striated and at one pole, where there is an operculum, it is slightly flattened." The size of the eggs is not given, but from the figure they appear to be slightly more than 0.1 mm. long and nearly 0.06 mm. wide.

This species differs only in very small details from *S. capensis* Mönnig, 1923, which is recorded from closely-related birds in South Africa.

OXYURIDÆ OF UNCERTAIN POSITION.

(" *Oxyuris* " sens. lat.)

Under this heading must be mentioned certain species which have not yet been adequately described, and whose systematic position cannot at present be decided.

1. "*Oxyuris*" *sciuri* Hall, 1916.

Synonym :—" *Oxyuris* sp. ? " Parona, 1889.

Host :—*Sciurus atridorsalis*; Kokarit, Tenasserim. Parona states that the worms were found in the nostrils and mouth, but expresses the opinion that they must in reality have come from the stomach or, more probably, the intestine.

The male is unknown, and Parona's very brief description of the female is insufficient to enable the species to be assigned to a modern genus.

The female, according to Parona, is 17 mm. long and 0.049 [? 0.49] mm. in thickness. The body is much attenuated posteriorly. The head is without lateral dilatations. The mouth has papillæ and distinct internal folds. The œsophageal bulb is described as having two swellings, the anterior situated at 0.75 mm. from the " buccal atrium " and having a transverse diameter of 0.07 mm., and the posterior measuring 0.021 [? 0.21] mm. in diameter. Hall (1916) interprets the anterior swelling as the posterior end of the œsophagus proper (*i. e.* a prebulbar swelling) and the posterior swelling as the real bulb. In this he is probably correct. The anus is said to be " terminal," but Parona also states that the tail terminates, behind the anus, in a spike 0.04 mm. long. The vulva is situated at 6 mm. from the anterior end. The ovary is very long, and the oviduct narrow and closely coiled.

2. "**Oxyuris**" **longicaudata** Meyer, 1896.

Host :—A Myriopod (*Julus* sp.); Ceylon.

According to Parona (1898) this species is synonymous with his own "*Oxyuris*" *sumatrensis* (1896), from *Platyrhacus modiglianii* in Sumatra. A comparison of the descriptions given by Meyer and Parona does not seem to support this view, although there are certain resemblances which suggest a possible generic relationship between the two species. In both cases the male is unknown.

The female, in Meyer's species, measures 5.5–6 mm. in length and 0.5 mm. in thickness. The cuticle is transversely folded. "The almost funnel-shaped buccal cavity leads to a small chitinous ring, and on the inner surface of the mouth one observes three quadrangular chitinous plates, joined at their bases by the ring." The œsophagus occupies one-seventh of the total length. The bulb is globular and much wider than the œsophagus proper. The tail is 1 mm. long, narrows suddenly behind the anus and runs out to a sharp point. The vulva is situated at about the middle of the body. The vagina is short and runs forward. The uterine branches are parallel and anterior. The coils of the ovarian tubes extend forward nearly as far as the œsophagus, and posteriorly to the beginning of the rectum. The eggs are oval, with thick shells which become thinner at both poles, and measure 0.0675×0.038 mm.

3. "**Oxyuris**" sp. Parona, 1889.

Host :—*Calotes* sp.; Jadò, Carin Mts., Burma.

Concerning this species Parona states that the female is 20 mm. long; the head has lateral membranes; the œsophageal bulb is large and measures $1/17$ mm. in length; the tail is very slender, with a long terminal spike; the vulva is in the anterior third of the body.

4. "**Oxyuris**" sp. Shipley and Hornell, 1904.

Host :—Pearl oyster (*Margaritifera vulgaris*) (intestine) Ceylon.

This species was "met with but twice, and both specimens were unfortunately lost. They measured barely $\frac{1}{8}$ inch in length."

APPENDIX TO FAMILY OXYURIDÆ.

1. "**Oxyuris**" **compar** Leidy, 1856.

This species, described by Leidy from the small intestine of a cat in the United States of America, is of somewhat

doubtful status. According to Hall (1922), Leidy's specimens were probably examples of *Passalurus ambiguus*, a parasite of rabbits, and had been accidentally swallowed by the cat. Price (1930), however, who has examined some of Leidy's original female specimens, considers *O. compar* a good species, and refers it to the genus *Wellcomia* Sambon, 1907. He still appears to think it a "pseudoparasite" of the cat, derived from some wild mammal. Baylis and Daubney (1922) doubtfully referred to *O. compar* a single specimen obtained from a cat in Calcutta. This specimen, kindly lent to the writer by the Director of the Indian Museum for re-examination, proves to be a female of some species of *Heterakis*. It is almost impossible to distinguish between the females of many of the species of *Heterakis* occurring in Indian birds, and no attempt has been made to assign this specimen to any of them. It was doubtless derived from a chicken or other bird whose viscera had been eaten by the cat.

5. Family ATRACTIDÆ Travassos, 1920.

Small parasitic forms in which the lips may be three or six, but are sometimes not apparent. A pharynx is usually absent. The three-lipped forms may possess eversible jaws or fringes of bristles. The œsophagus consists of a relatively short, cylindrical or club-shaped, muscular, anterior portion and a pyriform, granular, posterior bulb, with a long neck which is sometimes narrower than the anterior portion. Cervical alæ are absent. The tail of the male is without alæ. The reproductive organs are of a simple type. The male has two spicules. The vulva is close to the anus. The female genital tube is single. The eggs are few and very large. The worms are viviparous.

Key to Genera.

- | | |
|---|-------------------|
| Parasites of horse tribe and rhinoceroses ; with three complex lips, each having two eversible "jaws" bearing rows of bristles | [p. 209. |
| Parasites of reptiles or fishes ; with six simple lips | CROSSOCEPHALUS, |
| 1. Œsophagus with stout, cylindrical anterior portion with thick cuticular lining, and flask-shaped posterior bulb | 1. |
| Œsophagus with short, muscular, anterior portion and longer, partly glandular, posterior portion forming a small bulb at its hinder end | ATRACTIS, p. 207. |
| | [p. 210. |
| | MONHYSTERIDES, |

1. Genus **ATRACTIS** Dujardin, 1845.

Lips apparently six, not very distinct. Œsophagus consists of a stout, cylindrical anterior portion with a thick cuticular lining, and a flask-shaped bulb whose neck is narrower than the anterior portion. Tail of male narrowed behind the cloacal aperture to form a tapering filament. Eight to ten pairs of caudal papillæ present, of which four pairs are preanal or adanal. Spicules unequal and markedly dissimilar. A tubular accessory piece present. Tail of female conical. Adult worms parasitic in the intestine of lizards and tortoises.

Genotype :—*Atractis dactyluris* (Rudolphi, 1819).

Key to Species.

Parasite of tortoises.
Parasite of iguanas.

granulosa, p. 207.
opeatura, p. 208.

1. ***Atractis granulosa*** (Railliet and Henry, 1912) Thapar, 1925.

Synonym :—*Atractis dactyluris* (Rudolphi, 1819) var. *granulosa* Railliet and Henry, 1912.

Host :—*Testudo emys* (intestine); locality not stated (this tortoise occurs in Assam and Burma). The type host of *A. dactyluris* (Rud.) is the European tortoise, *Testudo græca*. Unfortunately the older descriptions of *A. dactyluris* are inadequate, and there are considerable discrepancies between the various more recent accounts purporting to deal with it, some of which have been based on other than European material. Baylis and Daubney (1922) recorded young female specimens, assumed to be of this species, from the intestine of *Testudo elongata* at Baradighi, Jalpaiguri, Bengal, but it appears questionable whether the typical form of *A. dactyluris* occurs in India. Thapar (1925), in describing what he regards as *A. dactyluris* from *Testudo tabulata* (a South American tortoise), quotes as a synonym "*Atractis granulosa* Railliet and Henry." It appears almost certain that the form described by Railliet and Henry is distinct from that of Thapar, and doubtful whether it is identical with the European form. It seems advisable, therefore, to treat it here as an independent species, under the name of *A. granulosa*.

The following characters are taken from the description by Railliet and Henry.

The male measures 4.7–5.25 mm. in length and 0.2–0.22 mm. in maximum thickness, the female 5–5.7 mm. and 0.32–0.35 mm. respectively. The cuticular striations are very fine. There are six lips, each bearing a papilla. The œsophagus occupies 1/9 to 1/7 of the total length, measuring in the male 0.73–0.775 mm. and in the female 0.75–0.815 mm.

Its anterior portion is the longer, occupying about $\frac{4}{7}$ of its total length, and is hexagonal in section, with a thick cuticular lining. The excretory pore is situated behind the œsophagus, at 1–1.18 mm. from the anterior extremity, and leads into a bladder with thick, striated walls.

The posterior half of the male is curved. On each side of the mid-ventral line, in the posterior region of the body, there is a yellowish longitudinal band, composed of closely-set "chitinous punctuations." The bands are irregularly interrupted in one or two places. The tail measures 0.5–0.525 mm. in length, and is narrowed in its posterior third to form a tapering filament. The lips of the cloacal aperture are somewhat prominent. There are ten pairs of caudal papillæ (six postanal and four preanal). The first, fourth and sixth papilla from the posterior end on each side are laterally placed. The spicules are unequal, the longer being slender and measuring 0.415–0.5 mm. in length, the shorter 0.106–0.118 mm. long, stouter and strongly chitinized, shaped like a claw with a blunt point and provided with a small ala. The accessory piece is conical and hollow, and measures 0.126–0.13 mm. in length and 0.028 mm. in width at its base. It has an aperture 8–9 μ wide at its tip.

The tail of the female measures 0.55–0.65 mm. in length. The vulva is situated at a distance of about 0.09 mm. from the anus. The uterus sometimes contains one or two large, ellipsoidal eggs measuring 0.48–0.5 \times 0.2–0.225 mm. Embryos were not seen.

2. *Atractis opeatura* Leidy, 1891. (Fig. 108.)

Synonyms:—*Atractis (Ascaris) opeatura* Leidy, 1891; *Atractis subulata* Coll. Leidy, in Stiles and Hassall, 1894; *Atractis cruciata* v. Linstow, 1902.

Hosts:—This species is a parasite of the intestine of iguanas, which are not natives of India, but of South America and other parts of the world. It has been recorded by Baylis and Daubney (1922) from an iguana in captivity in the Zoological Gardens, Calcutta.

The male measures 4–5 mm. in length and 0.2–0.28 mm. in maximum thickness, the female 5–6.22 mm. and 0.29–0.35 mm. respectively. The body of the male is spirally coiled, at least in the posterior half. That of the female is not coiled. The cuticular striations are at intervals of about 1.6 μ , and are conspicuous only in the œsophageal region. There are six lips, each having a finger-shaped pulp and an apical papilla. The œsophagus occupies about $\frac{1}{6}$ to $\frac{1}{5}$ of the total length. Its anterior portion is slightly the longer. The excretory pore, which is surrounded by a crown of chitinoid rods, is

slightly in front of the œsophageal bulb, according to Railliet and Henry, or at 0.79–0.88 mm. from the anterior end according to v. Linstow. The nerve-ring is situated at the junction of the two portions of the œsophagus, and the cervical papillæ just in front of this point, at 0.48 mm. from the anterior end.

The tail of the male measures 0.375 mm. in length according to Leidy, or $1/16.3$ of the total length according to v. Linstow. There are eight pairs of caudal papillæ (four postanal, one adanal and three preanal). The three most posterior pairs

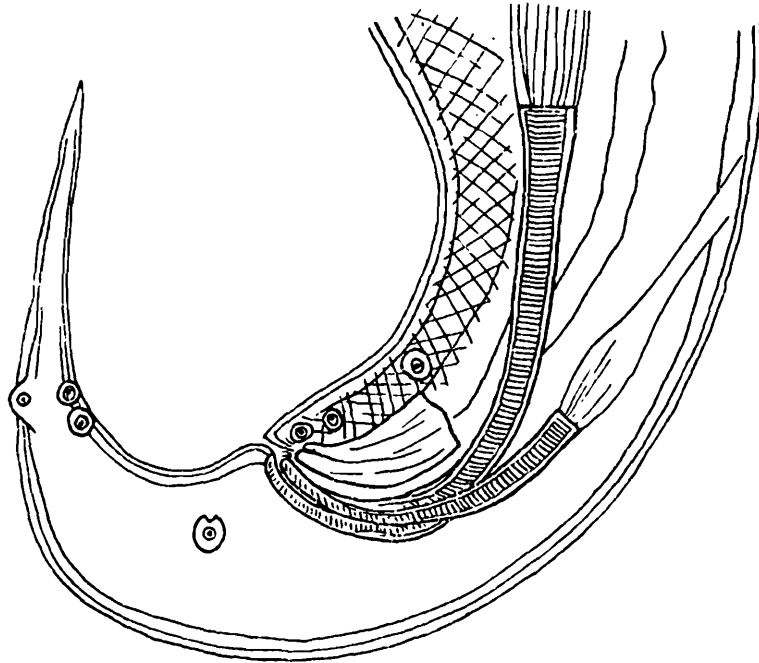

Fig. 108.—*Atractis opeatura*. Posterior end of male; lateral view.
(After v. Linstow.)

form a group, of which one is dorsally situated. The spicules are transversely striated. The longer measures 0.42–0.44 mm. in length and 0.03 mm. in thickness, the shorter 0.19–0.29 mm. and 0.014 mm. respectively. The accessory piece is tubular and 0.1–0.176 mm. long.

The tail of the female measures 0.6–0.7 mm. in length. The vulva is situated at a distance of 0.3 mm. from the anus. The uterus contains eggs with a membranous shell, measuring 0.18–0.19 × 0.062–0.079 mm., and also embryos, already hatched, measuring 2.15–2.4 mm. in length and 0.12 mm. in thickness.

2. Genus **CROSSOCEPHALUS** Railliet, 1909.

Synonym:—*Pterocephalus* v. Linstow, 1899, *nec* Schneider, 1887.

Mouth with three distinct lips, each bearing two chitinoid jaws. Each jaw with a terminal tooth and a row of bristles externally. The jaws are eversible, and when inverted are

lodged in the anterior part of the lumen of the œsophagus. Behind the lips a cuticular collar bearing a pair of prominent, horn-like lateral papillæ. Tail of male bluntly conical. Up to ten pairs of rather small caudal papillæ present. Spicules unequal. No accessory piece. Tail of female narrows suddenly behind the anus and tapers to a fine point. Adult worms in the alimentary canal of Perissodactyle mammals (horse tribe and rhinoceroses).

Genotype :—*Crossocephalus viviparus* (v. Linstow, 1899).

1. *Crossocephalus brevicaudatus* Baylis and Daubney, 1923.

Host :—Indian rhinoceros (*Rhinoceros unicornis* [*R. indicus*]) (stomach) ; Nepal terai, India.

The male of this species is unknown. The following description of the female is taken from Baylis and Daubney (1923, *b*) :—

“The specimens measure from 5·3 to 6·2 mm. in length and up to 0·4 mm. in maximum thickness. The head has the usual characteristics of the genus. It is furnished with three pairs of armed jaws, and a pair of very prominent ear-like papillæ on the cuticular collar. No cervical papillæ have been seen. The œsophagus is from 0·945 to 0·955 mm. long. The excretory pore is situated at 1·22 to 1·35 mm. from the anterior end. Its lips are surrounded by a prominent, wrinkled, cuticular swelling, and connected with the pore is an ovoid bladder measuring about 0·13 mm. × 0·08 mm.

“The tail is short and blunt, measuring about 0·25 mm. The vulva is situated about 0·13 mm. in front of the anus. The uterus contains from six to eight embryos, varying in size according to the degree of their development, but extremely large in the later stages.”

3. Genus **MONHYSTERIDES** Baylis and Daubney, 1922.

Mouth with six small lips. Œsophagus with a short, muscular, anterior portion and a longer, partly glandular, posterior portion, the hinder end of which forms a small bulb. Caudal end of male tapering, with a few pairs of small papillæ (in the genotype five pairs postanal and four pairs preanal). Spicules tubular. Accessory piece small or absent. Adult worms in the alimentary canal of fishes and freshwater tortoises.

Genotype :—*Monhysterides piscicola* Baylis and Daubney, 1922.

Key to Species.

Parasite of fish	<i>piscicola</i> , p. 211.
Parasite of tortoise.	<i>kachugæ</i> , p. 213.

1. *Monhysterides piscicola* Baylis and Daubney, 1922.
(Figs. 109 & 110.)

Host :—Mahseer (*Barbus tor*); Torsa River, Falakata, Eastern Bengal.

The male measures 3·5–4 mm. in length, the female 3·7–4·4 mm. The maximum thickness is 0·15–0·2 mm. The body is slender and tapering towards each extremity, the middle

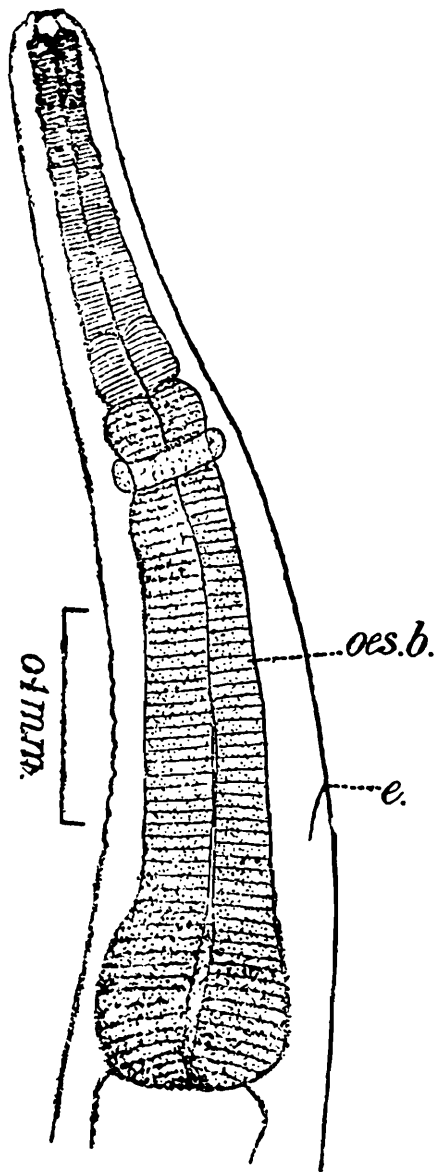

Fig. 109.—*Monhysterides piscicola*. Anterior end of female; lateral view. *e.*, excretory pore; *oes.b.*, oesophageal bulb. (After Baylis and Daubney.)

region being relatively stout. The cuticular striations are exceedingly fine. The diameter of the head is 0·03–0·04 mm. The oesophagus consists of a short anterior portion which is transparent and purely muscular, and a longer posterior portion which is granular in appearance, but also muscular,

and is swollen behind. The anterior portion is about 0.2 mm. long, and is divided near its posterior end into two parts of slightly different histological appearance. The posterior portion, which may be regarded as a very elongate bulb, measures about 0.32 mm. in length and 0.065–0.09 mm. in maximum thickness. The nerve-ring surrounds the neck of the bulb near its origin, at a distance of about 0.22 mm. from the anterior end of the body. The excretory pore is situated at about 0.4 mm. from the anterior end.

The tail of the male is 0.34 mm. long and tapers to a very fine point. Of the five pairs of postanal papillæ, two are lateral

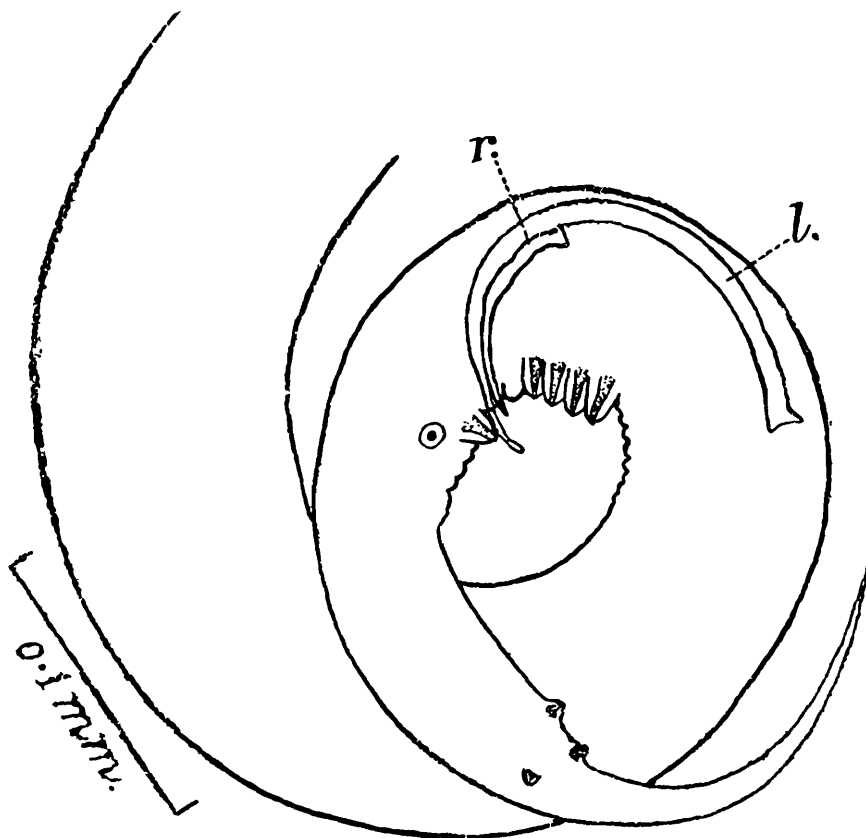

Fig. 110.—*Monhysterides piscicola*. Posterior end of male; lateral view. *l.*, left spicule; *r.*, right spicule. (After Baylis and Daubney.)

and three subventral. The four pairs of preanal papillæ are placed very close together just in front of the cloacal aperture, and these and the most anterior pair of postanal papillæ are subventral and prominent. The left spicule measures 0.21 mm. in length and has a bluntly rounded tip. The right spicule is more pointed and measures only 0.08 mm. There is no accessory piece.

The tail of the female is finely tapering and measures 0.55–0.65 mm. in length. The vulva is situated at about 0.45 mm. from the anus, and the uterus and ovary are single. The latter is situated anteriorly, and is reflexed at about

1.2 mm. from the anterior end. The worm is viviparous, the embryos being at first enclosed in large, oval, membranous shells, measuring 0.275×0.125 mm., but subsequently hatching *in utero*. The voluminous uterus may contain at one time some 15 to 20 eggs, containing embryos in various stages of development, and about four or five free embryos. The latter are about 1 mm. long, or roughly a quarter of the length of the parent.

2. *Monhysterides kachugæ* (Stewart, 1914).

Synonym :—*Atractis kachugæ* Stewart, 1914.

Host :—*Kachuga kachuga* [*K. lineata*] (intestine) ; Lucknow.

The male measures 2.24 mm. in length and 0.044 mm. in maximum thickness, the female 2.17–3.06 mm. and 0.04–0.077 mm. respectively. “The head bears a circle of six lips—two lateral with simple peg-like pulpa and four submedian which possess a pulpa of a curious cross-like figure springing from a thick pedestal.” Lateral alæ extend from the level of the posterior end of the œsophagus to behind the anus. The œsophagus is 0.349–0.459 mm. long. Its anterior portion is muscular and measures 0.15–0.17 mm. in length, including a short “pharynx,” 0.005 mm. long. Its posterior portion, or bulb, is granular and measures 0.199–0.255 mm. in length.

The tail of the male is 0.374 mm. long. There are three pairs of caudal papillæ (two pairs preanal, one postanal). The left spicule measures 0.187 mm. in length and 0.005 mm. in thickness, and is tubular and tapering, with a slightly expanded root. The right spicule is 0.0925 mm. long and 0.0042 mm. thick, and is “nail-shaped with a distinct closed head.”

The tail of the female measures 0.493–0.731 mm. in length. The vulva is situated at a distance of 0.102 mm. from the anus, and has slightly prominent lips. In mature specimens the uterus contains from six to eight embryos, which are never coiled or enclosed in a shell.

6. Family RHABDITIDÆ Micoletzky, 1922.

Small forms, free-living or parasitic, or with both free-living and parasitic phases, with a three-sided, prismatic or tubular buccal cavity, usually without teeth. Œsophagus usually with a posterior bulb containing valves, and frequently also with a prebulbar swelling. Cuticle without bristles, or with very few. Reproductive organs simple. Oviparous or viviparous, not infrequently parthenogenetic or hermaphrodite.

Subfamily RHABDITINÆ Micoletzky, 1922.

Buccal cavity elongate, typically a three-sided tube without tooth-like structures. Lateral organs and caudal gland generally absent. Excretory system typically in the form of lateral canals. Testis usually single.

Of this subfamily the two genera to be considered here have a parasitic phase—*Rhabdias* in the lungs of amphibians and reptiles, *Strongyloides* in the intestine of vertebrates.

1. Genus RHABDIAS Stiles and Hassall, 1905.

Synonyms :—*Angiostoma* Dujardin, 1845 (part); *Angiostoma* and *Angiostomum* auctt. (part); *Leptodera* Schneider, 1866 (part), nec Dujardin, 1845; *Rhabdonema* Leuckart, 1879 (part).

Free-living generation.—Microscopic forms. Sexes separate. Body fairly stout. A short buccal capsule present. Œsophagus with a fusiform prebulbar swelling and a pyriform posterior bulb. Tail of male conical, with a short terminal spike and narrow lateral alæ. A few pairs of caudal papillæ present (typically four pairs preanal and three pairs postanal), all laterally placed. Spicules equal, short and stout. Apparently no accessory piece. Tail of female conical. Vulva somewhat behind the middle of the body. Uterine branches opposed. Eggs very few and large. Embryos hatch within the uterus and are retained until the death of the female.

Parasitic generation.—Much larger than the free-living generation, and consisting of "female" forms only, which are probably protandrous hermaphrodites. Body rather slender. A short, cup-shaped buccal capsule present. Œsophagus cylindrical, sometimes with a slight constriction at about the middle, but without a posterior bulb. Tail conical. Vulva near the middle of the body, opening directly into

the uterus, which has two opposed branches. Ovaries reflexed. Eggs segmenting or containing an embryo when laid. Adult worms (parasitic form) in the lungs of amphibians and reptiles; free-living stages in the fæces of these animals or in the soil.

Genotype :—*Rhabdias bufonis* (Schrank, 1788).

1. *Rhabdias escheri* Baer, 1930.

Host :—A cæcilian (*Uræotyphlus oxyurus*) (body-cavity); Palni Hills, South India.

Of this species the parasitic form only is known. The specimens were immature, and measured 5–6 mm. in length and 0.25–0.26 mm. in maximum thickness. The cuticle is very thin, and has fine transverse striations, visible mainly in the œsophageal region. The buccal capsule measures 0.0145 mm. both in length and in internal diameter. The œsophagus is 0.5 mm. long, and increases in thickness from 0.05 mm. anteriorly to 0.07 mm. posteriorly. The nerve-ring is situated at about its anterior third. The rectum is 0.08 mm. long, and three large rectal glands open into it. The tail is bluntly conical and measures 0.12 mm. in length. The vulva is said to be situated at about 0.15 mm. from the anterior end of the body, but is figured as being at about the middle.

2. Genus **STRONGYLOIDES** Grassi, 1879.

Synonyms :—*Rhabdonema* Leuckart, 1879, et auctt. (part); *Pseudorhabditis* Perroncito, 1880, nec Szüts, 1912; *Stercoralis* Tanaka, 1910.

Free-living (“*rhabditiform*”) *generation*.—Microscopic forms, comparatively stout. Sexes separate. Mouth surrounded by six papillæ. A short, cylindrical buccal capsule present. Œsophagus club-shaped, connected by a narrow neck with a pyriform posterior bulb. Tail of male short and conical. Caudal papillæ few, including one pair of preanal papillæ. Spicules short, stout and equal. An accessory piece present. Tail of female somewhat longer than that of the male, and tapering. Vulva near the middle of the body, opening directly into the uterine branches, which are opposed. Ovaries reflexed. Eggs few and large, oval, thin-shelled, with contents segmenting at the time of laying or, in the case of older females, hatching *in utero*.

Parasitic generation.—Male, when known, “*rhabditiform*” and very similar to the free-living male. Female “*filiform*,” with body considerably longer than in the free-living generation, and very slender. A short buccal capsule present. Œsophagus long, slender, almost cylindrical and without

a posterior bulb. Tail short and conical or blunt. Vulva in posterior half of body, opening directly into the uterine branches, which are opposed. Ovaries reflexed. Eggs may contain segmentation-stages or embryos when laid.

Adult parasitic forms in the intestine of vertebrates. Free-living stages in the fæces of these animals or in the soil.

Genotype :—*Strongyloides stercoralis* (Bavay, 1876).

Key to Species.

Parasite of man	<i>stercoralis</i> , p. 216.
Parasite of cat	<i>felis</i> , p. 219.
Parasite of sheep, ox, pig, monkeys, etc..	<i>papillosus</i> , p. 220.

1. *Strongyloides stercoralis* (Bavay, 1876). (Fig. 111.)

Synonyms :—*Anguillula stercoralis* Bavay, in Normand, 1876; *Rhabditis stercoralis* Bavay, 1876; *Anguillula intestinalis* Bavay, in Normand, 1877, nec Ehrenberg, 1838; *Strongyloides intestinalis* Grassi, 1879; *Leptodera intestinalis* Cobbold, 1879; *Leptodera stercoralis* Cobbold, 1879; *Leptodera (Anguillula) stercoralis* Cobbold, 1879; *Rhabditis intestinalis* Örley, 1880; *Pseudorhabditis stercoralis* Perroncito, 1880; *Pseudorhabditis intestinalis* Perroncito, 1881; *Rhabdonema strongyloides* [? Leuckart, 1883] Braun, 1883; *Rhabditis (Anguillula) intestinalis* Braun, 1883; *Rhabdonema hominis* Lutz, 1887; *Rhabdonema intestinale* Blanchard, 1888; *Leptodera strongyloides* Rolleston, 1888, nec Schneider, 1866; *Strongyloides (Rhabdonema) intestinalis* Calandruccio, 1889; *Rhabditis strongyloides* Blanchard, 1890, nec Örley, 1880; *Rhabdonema stercoralis* Manson, 1903; *Anguillula strongyloides* Calandruccio, 1904; *Stercoralis intestinalis* Tanaka, 1910; ? *Strongyloides canis* Brumpt, 1922.

Hosts :—This is a common parasite of man, and is widely distributed, especially in warm countries. It is of frequent occurrence in man in India, Ceylon and Burma. Chandler (1928) states that there is evidence that in Orissa its incidence is not less than 10 per cent. of the population. *S. stercoralis* has been recorded in various apes and monkeys, though the determination of the species is open to question. Fülleborn has also recorded it in a Chinese dog, but Brumpt regards the form in the dog as a distinct species, *S. canis*. The status of this and of various other forms or varieties, to which distinctive names have been given, is still very uncertain. Chandler has described a form from the cat which he regards as a variety of *S. stercoralis* (var. *felis*). This is here treated as a distinct species, and is described below under the name of *S. felis*.

The adult female parasitic form measures about 2–4 mm. in length and about 0·03 mm. in maximum thickness. The oesophagus is about 0·6 mm. long and the tail 0·1 mm. The vulva is situated at or behind the posterior third of the body. The eggs are oval and measure 0·05–0·058 × 0·03–0·034 mm.

Kreis (1932) and Faust (1933) have described a parasitic male form in man and the dog which is very similar to the free-living male, having an œsophagus of the rhabditiform and not of the filariform type, and a wide buccal cavity followed by a cylindrical buccal capsule. According to Kreis' description this parasitic male, as it occurs in man, measures about 0.49–0.74 mm. in length, and apparently about 0.035–0.04 mm. in maximum thickness. The œsophagus (as calculated from the formula given by Kreis) is about 0.1–0.11 mm. long.

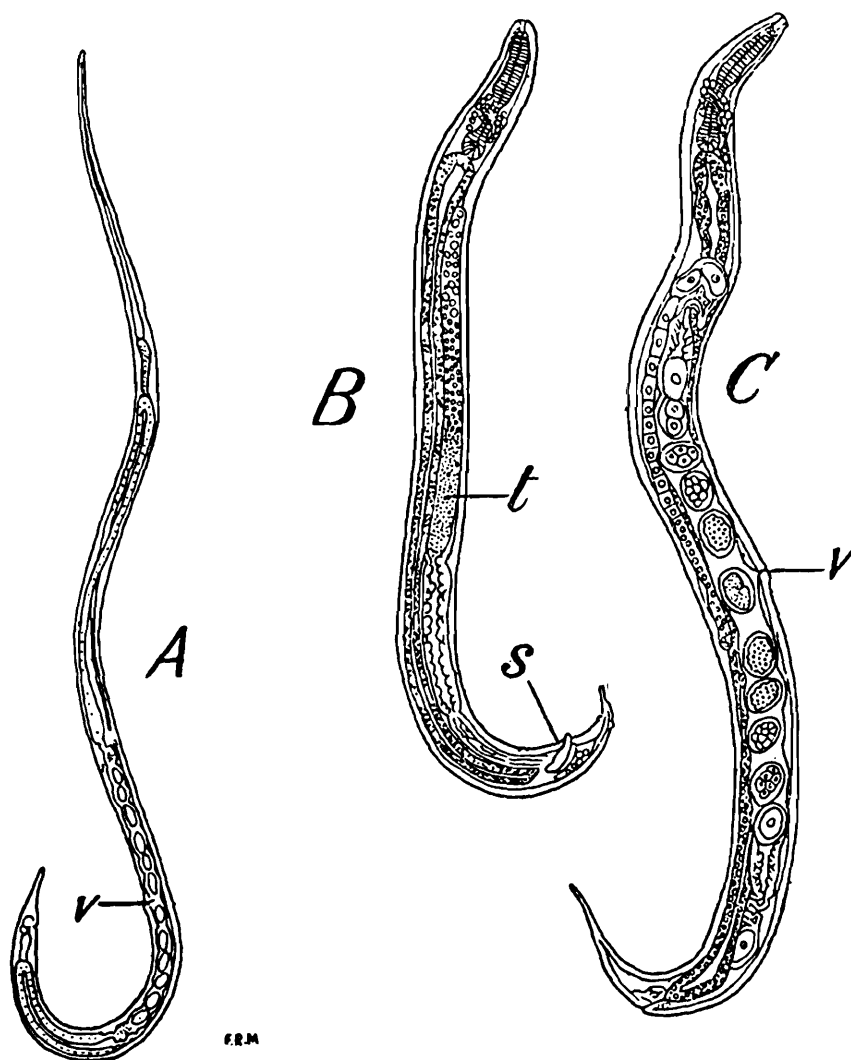

Fig. 111.—*Strongyloides stercoralis*. A, female parasitic form; B, C, male and female of free-living form. *s.*, spicule; *t.*, testis; *v.*, vulva. (From Baylis, after Looss.)

Its anterior portion contains three "spears" about 0.018 mm. long. The posterior bulb measures 0.018 mm. in length and 0.014 mm. in width. The nerve-ring surrounds the narrow portion of the œsophagus, at about the posterior third of the whole organ. The tail is tapering and pointed and appears to measure about 0.06–0.07 mm. in length. There is a large preanal papilla (or accessory organ) and two pairs of small

postanal papillæ. The spicules are broad and measure 0.034–0.041 mm. in length. The accessory piece is 0.022–0.023 mm. long. The testis occupies more than half the length of the body, and is reflexed.

The proportions are slightly different in the form found in dogs, the body being more slender and the tail shorter.

The rhabditiform larva (the offspring of the parasitic form) measures 0.2–0.25 mm. in length and 0.016 mm. in thickness soon after hatching, but often grows to two or three times this size before being passed out of the body of the host.

The adult free-living form measures about 0.7 mm. in length and 0.035–0.05 mm. in thickness in the male, and about 1–1.3 mm. in length and 0.05–0.075 mm. in thickness in the female. The tail of the male is about 0.05 mm. long. There are three pairs of caudal papillæ—a subventral preanal pair and two postanal pairs, of which one is subventral and one subdorsal, near the middle of the tail. The spicules are strongly curved and measure about 0.038 mm. in length. The tail of the female is about 0.12 mm. long. The eggs are thin-shelled and measure about 0.07×0.04 –0.045 mm. In old females the eggs may hatch while still retained in the uterus.

The filariform (infective) larva measures about 0.4–0.7 mm. in length and 0.016–0.018 mm. in thickness. The œsophagus is about 0.2–0.3 mm. long and the tail 0.07–0.1 mm.

The life-history of this and other species of the genus is still imperfectly understood. The filariform larvæ have the power of penetrating the skin of the host, and this appears, in fact, to be the usual mode of infection. After entering the body in this way they go through a course of migration very similar to that of *Ascaris* (see p. 38) before settling permanently in the alimentary canal. In the course of this migration they undergo considerable development. It had for many years been supposed that the parasitic phase always consisted of female forms only, and that these were either parthenogenetic or hermaphrodite. The researches of Kreis and of Faust, however, appear to indicate that in certain strains in man and the dog there may also be parasitic males. Faust finds these particularly in the lungs of experimental hosts, and suggests that they there fertilize adolescent females which later migrate to the intestine. The males seem to be comparatively rare in the intestine. On reaching the intestine, the females burrow into the mucous membrane or into Lieberkühn's glands. Here the eggs are laid and hatch. The larvæ enter the lumen of the intestine and are passed out with the fæces as rhabditiform larvæ. These may develop into a free-living bisexual generation, whose progeny are of the infective (filariform) type, or they may themselves become transformed directly into filariform larvæ, the free-living

bisexual stage being thus omitted. The factors controlling the occurrence of these alternative modes of development are obscure. The ingenious suggestion has been made by Faust that the parasitic females may lay at first fertilized and later unfertilized eggs, and that the former may give rise to larvæ which follow the indirect mode, while the latter give rise to larvæ which are directly transformed.

According to Stekhoven (1928), the transformation of rhabditiform into filariform larvæ sometimes takes place in the host's intestine, and he infers from this that reinfection of the same host may occur without the necessity for larvæ to enter the body from outside. Faust states that not only eggs and rhabditiform larvæ, but also infective filariform larvæ, may be found in the lungs, and that all these are the progeny of adult worms living in the lung-tissues and bronchioles. Hyperinfection may therefore take place in the lungs.

2. *Strongyloides felis* (Chandler, 1925).

Synonym :—*Strongyloides stercoralis* var. *felis* Chandler, 1925.

Host :—Domestic cat (upper part of duodenum). Chandler records the occurrence of the parasite in about 20 per cent. of the cats examined by him in Calcutta.

The adult female parasitic form measures 2.6–2.92 mm. in length and 0.039–0.045 mm. in maximum thickness. The head has a diameter of about 0.014 mm. There are three fairly prominent lips. The cuticle is finely striated. The œsophagus occupies about a quarter of the total length. The tail measures 0.063–0.104 mm. in length and tapers evenly to the tip, which is bluntly pointed. The vulva is situated at 66.6–68 per cent. of the total length from the anterior end. The uterus contains from five to eight fully-developed eggs at a time. Those nearest to the vulva are often already hatched.

The adult free-living form measures 0.895–0.985 mm. in length and 0.04–0.045 mm. in thickness in the male, 1–1.2 mm. and 0.039–0.046 mm. respectively in the female. The head has a diameter of about 0.014 mm. The œsophagus occupies about one-seventh of the total length. The tail of the male is 0.063–0.079 mm. long, and apparently bears no postanal papillæ. A pair of inconspicuous preanal papillæ is present. The spicules measure 0.032–0.036 mm. in length, and the accessory piece 0.021–0.0225 mm. The tail of the female is slender and sharply pointed, and measures 0.094–0.11 mm. in length. The vulva is very prominent, and the body diminishes in diameter behind it.

The filariform (infective) larva measures 0.525–0.615 mm. in length and 0.014–0.016 mm. in thickness. The average

length and thickness are 0.578 mm. and 0.015 mm. respectively. The average length of the œsophagus is 44 per cent. of the total length (about 0.243 mm.).

Chandler states that this form differs from the typical *S. stercoralis* of man in its slightly larger size, in the proportional lengths of the œsophagus and tail, and in the fact that it is ovoviviparous (eggs never being found in the intestine or fæces of cats, but only hatched embryos). The free-living bisexual generation occurs much more frequently than the transformation of rhabditiform into filariform larvæ, and perhaps exclusively.

On account of the differences in the caudal papillæ of the free-living male, and the various discrepancies in the measurements of all stages, the writer feels unable to regard this form as a mere variety of *S. stercoralis*.

3. *Strongyloides papillosus* (Wedl, 1856) Ransom, 1911.

Synonyms:—*Trichosoma papillosum* Wedl, 1856, *nec v.* Linstow, 1878, *nec* Fritsch, 1886, *nec* Blome, 1909; *Rhabdonema longus* Grassi, 1885; *Strongyloides longus* Rovelli, 1888; *Rhabdonema longum* Railliet, 1893; *Strongyloides longus bovis* de Gaspari, 1912; ? *Rhabdonema suis* Dolley, 1894; ? *Strongyloides suis v.* Linstow, 1905; ? *Strongyloides fülleborni v.* Linstow, 1905; ? *Strongyloides cebus* Darling, 1911; ? *Strongyloides ovocinctus* Ransom, 1911; ? *Strongyloides vituli* Brumpt, 1921; ? *Strongyloides simiæ* Hung and Höppli, 1923.

Hosts:—This species has been recorded from a variety of animals, including the sheep, goat, ox, pig, rabbit and rat, and has a wide geographical range. Various forms recorded from monkeys are regarded by Chandler (1925, *a*) as representing, at the most, subspecies, and perhaps only host-varieties, of *S. papillosus*. One such form is recorded by Chandler himself from *Macacus rhesus* in Calcutta and from the Hoolock gibbon (*Hylobates hoolock*) in the Zoological Gardens, Calcutta. The following characterization is taken from his description of this form.

The adult female parasitic form, whose habitat is the lower part of the duodenum, measures 3–3.25 mm. in length and 0.045–0.05 mm. in maximum thickness. The head has a diameter of about 0.017 mm., and there are apparently six very inconspicuous lips. The cuticle is finely striated. The œsophagus is 0.82–0.87 mm. long (a little more than a quarter of the total length). The tail measures 0.042–0.056 mm. in length. Its diameter is suddenly reduced just behind the anus, and its tip is bluntly rounded. The vulva is situated at 60–63 per cent. of the total length from the

anterior end of the body. The uterus contains from six to eight fully-developed eggs at a time.

The adult free-living form measures 0.7–0.8 mm. in length and 0.036–0.042 mm. in thickness in the male, and 0.98–1.26 mm. and 0.053–0.075 mm. (excluding the vulvar prominence) respectively in the female. The head has a diameter of about 0.015 mm. The œsophagus, in the female, measures 0.143–0.182 mm. in length (about 1/8 to 1/7 of the total length). The tail of the male is 0.056–0.07 mm. long, and bears a single, median postanal papilla near its middle. There is also a pair of preanal papillæ. The spicules measure 0.036–0.038 mm. in length and the accessory piece about 0.023 mm. The tail of the female is slender and sharply pointed, and measures 0.125–0.153 mm. in length. The vulva is very prominent, and varies in position from slightly in front of to slightly behind the middle of the body. The uterus contains from 15 to 27 fully-developed eggs at a time.

The filariform (infective) larva measures 0.635–0.697 mm. (average 0.656 mm.) in length and 0.016–0.017 mm. (average 0.0166 mm.) in thickness. The œsophagus averages 45 per cent. of the total length.

7. Family MERMITHIDÆ Braun, 1883.

Elongate and generally relatively slender forms (in the adult condition), with a smooth cuticle, frequently containing spiral fibres which run through it in criss-cross directions. Head usually with two lateral and four submedian papillæ, and often with additional small circumoral papillæ. A pair of lateral organs almost always present, often complex. Alimentary canal complete only in the larvæ. In the early larval stage the mouth is provided with a piercing stylet, which is lost after penetration into the host. In the adult the œsophagus becomes reduced to a simple, narrow, cuticular tube, and the intestine becomes modified into a sausage-shaped, solid fat-body, without an anal opening. Genital tubes usually paired in both sexes. Caudal end of male without alæ, but usually with three longitudinal rows of papillæ. A pair of spicules or a single spicule present. Vulva at about the middle of the body. Vagina short and muscular, frequently bent S-wise. Uterine branches opposed. Worms usually oviparous. Adults in soil or fresh water. Larvæ partly in soil or fresh water, partly parasitic in the body-cavity of Arthropods (chiefly insects) or Mollusca.

1. Genus **MERMIS** Dujardin, 1842.

This generic name is here used in a wide sense. A number of genera have been proposed for forms which differ from the genotype of *Mermis* in characters which appear too slight to justify generic rank, and until the group as a whole is much better known it seems desirable to adopt a conservative attitude towards them. For some discussion of this question see Baylis and Daubney, 1926, 'A Synopsis of the Families and Genera of Nematoda,' p. 64.

The generic diagnosis may, for the present, be taken as being the same as that of the family.

Genotype:—*Mermis nigrescens* Dujardin, 1842.

1. *Mermis nigrescens* Dujardin, 1842.

Synonyms:—? *Mermis meissneri* Cobb, 1926; ? *Mermis subnigrescens* Cobb, 1926.

Habitat:—This species lives partly in the soil and partly as a parasite in the body-cavity of insects, especially grasshoppers. It is common in Europe, and a specimen from Pashok, Darjeeling district, Eastern Himalayas (altitude 4000 ft.), was referred to it by Baylis and Daubney (1923, *b*). The North American form, *M. subnigrescens*, which was somewhat doubtfully regarded by Cobb as a distinct species, is recorded from various genera of grasshoppers.

The male measures up to 68 mm. in length and 0.26–0.28 mm. in thickness, the female 88–152 mm. and 0.42–0.6 mm. respectively. The head is rounded and followed by a slightly narrower neck. The diameter of the head is 0.114–0.119 mm. in the male and 0.13–0.14 mm. in the female. The head bears four small submedian papillæ, and a pair of more prominent lateral papillæ, situated further forward, close to the mouth. In the neck region there is usually a certain amount of yellowish-brown or reddish pigment. The cuticle includes a double layer of crossed fibres. There are six longitudinal "fields" in the subcuticular layer. The lateral organs are large and complex, and open by narrow canals at the level of the submedian cephalic papillæ. The œsophagus, in the adult, is a narrow, thin-walled cuticular tube, occupying about one-twentieth of the length of the body. The nerve-ring is situated, in the male, at 0.316–0.34 mm., and in the female at 0.45–0.46 mm., from the anterior extremity.

The tail is blunt in both sexes. In the male it is concave ventrally and measures 0.31–0.35 mm. in length. The caudal papillæ are numerous, and are arranged in three single rows, each composed of 30 to 35 papillæ and extending from some

distance in front of the cloacal aperture to the tip of the tail. The spicules measure 0.2–0.26 mm. in length and have a maximum width of about 0.025 mm. Their tips are blunt and their roots slightly expanded. The testes are paired and opposed. The posterior testis is considerably shorter than the anterior.

The position of the vulva is variable, but usually in front of the middle of the body. The eggs are very remarkable in this species. They are of lenticular or subglobular shape, with a shell which, when mature, is of a dark brown colour and measures 0.043 mm. in diameter. This is enclosed in a colourless outer shell or capsule, 0.05 mm. in diameter. The outer shell has an equatorial "breaking-point," while to each of its two opposite poles is attached a "byssus" of sticky threads. The uterus, containing large numbers of these dark-coloured eggs, shows through the translucent yellowish body-wall of the gravid female as a dark line, and gives the whole worm a somewhat greenish appearance. In the specimen from India mentioned above, which was a female, the eggs were of the same form and size as in European specimens, but the inner shell did not show the usual dark brown colour, being almost colourless. This may perhaps have been only a matter of age.

The gravid females of *M. nigrescens* have the habit of coming up out of the ground after heavy downpours of rain in summer (more especially after thunderstorms) and climbing on to plants. They are sometimes observed at a height of several feet from the ground. When numerous, they sometimes give rise to stories of "showers of worms." The eggs are laid on plants, to which they adhere, usually in bunches, by means of their sticky threads. They are thus liable to be swallowed by phytophagous insects. The larvæ then hatch and enter the body-cavity of the host. Although *M. nigrescens* has been recorded from a considerable variety of insects, the specific determination of the worm is in many cases open to question. Hagmeier has shown experimentally that this species is capable of developing in grasshoppers (various species of *Stenobothrus* and *Decticus*), and these are at present the only definitely ascertained hosts, though it is extremely probable that other insects also serve in that capacity.

During the parasitic period the intestine becomes a solid fat-body, and the anus becomes obliterated. The larva apparently feeds by absorption of the body-fluid of the host through its cuticle, and the food thus obtained is stored up in the form of globules of fat. When fully grown, but still quite immature, the larva emerges from the host (which almost immediately dies) and enters the soil. Here it remains

until sexually mature, this period of development taking about two years. The males remain buried, and the females appear above ground, as already mentioned, only for the purpose of oviposition.

2. *Mermis* sp. Iyengar, 1929.

Habitat :—A species (or possibly more than one species) of *Mermis* is recorded by Iyengar as a parasite of the larvæ of various mosquitoes of the genus *Anopheles* in Bengal. The mosquitoes found to be attacked were *A. minimus* var. *varuna* Iyengar (vel *A. varuna*), *A. pseudojamesi*, *A. sinensis*, *A. barbirostris*, *A. fuliginosus*, *A. philippinensis* and *A. tessellatus*. “The parasitization of *Anopheles* larvæ is especially common during the monsoons, in the months of August and September.”

According to Iyengar, “the worm when it emerges from the larva of *Anopheles* is long, white and opaque. It ranges from 5 mm. to 8 mm. long, and is usually from 63μ to 110μ thick. The anterior end is somewhat pointed and has a thin vestigial alimentary canal. The posterior end is pointed and ends in a papilla.”

Iyengar states that he has succeeded in rearing the larvæ to the adult stage in “a dish with a wet sand slope, and with a little water at the base of the dish.” Sexual maturity was reached within three weeks. “The male worms were generally thinner, and measured 4.4 mm. long and 55μ to 63μ thick. The females measured 11 mm. long and 140μ to 150μ thick. The head end was thinner and measured 80μ in thickness. By this time at least one moulting had taken place and the papilla at the posterior end [had] disappeared; the posterior end of the sexually mature worm is rounded.”

Iyengar believes that the worms are probably viviparous. No eggs were found in the cultures, but numerous larvæ. These measured 1–1.2 mm. in length and 12 – 14μ in thickness. They were very active, and moved rapidly near the surface of the water. The penetration of the larvæ into the body of the mosquito larva was observed. This is effected by means of the buccal stylet and by active boring movements of the body, the tail of the worm being meanwhile curled round one of the branched hairs of the host. “The whole process from the time of attachment to the time of complete entry takes from one to two minutes, sometimes slightly longer. . . The embryo grows at a remarkable rate and at the end of eight to ten days after the time of entry, it has grown from an original size of 1 mm. by 13μ to a size of 8 mm. by 75μ to 160μ . The mature embryo then emerges out of the *Anopheles* larva before the latter pupates.” The mosquito larva invariably dies immediately after the emergence of the worm.

In nature only a single *Mermis* larva was found in each infested mosquito larva. In experimental infections, although as many as twenty larvæ entered a single mosquito larva during one night, their number, Iyengar states, was gradually reduced until after four days only one remained. The fate of the others is unknown.

In addition to the form or forms of *Mermis* parasitic in the larvæ of *Anopheles*, Iyengar records others in the adults of *Anopheles fuliginosus* and *A. subpictus* in Bengal. These worms are considered to be specifically distinct from the former. They attain a larger size (8.3–17 mm. in length and 0.138–0.174 mm. in thickness) in the immature condition. They are said to emerge from the mosquitoes only when the latter are close to water, and to enter the water, in which presumably the adult stage would be found. Their further development, however, has not been followed. The mosquito dies immediately after the emergence of the worm.

3. *Mermis indica* v. Linstow, in Schultz, 1899.

This species was proposed for a larval specimen which was found to have emerged from a butterfly, *Papilio helenus*, sent from India to Germany in a paper envelope. The length of the worm was about 16 cm. The head was truncate and had six small papillæ. The tail had a dorsally-curved terminal appendage.

8. Family ANGUILLULINIDÆ Baylis and Daubney, 1926.

Synonym :—*Tylenchidæ* Micoletzky, 1922.

Small, free-living, semi-parasitic or parasitic forms. Pharynx in the adult modified into a protrusible stylet or "spear." Œsophagus simple or with a median and a posterior bulb-like swelling. When two swellings are present, only the anterior of them is a muscular bulb. Caudal glands and spinneret usually absent.

Subfamily ANGUILLULININÆ Baylis and Daubney, 1926.

Œsophagus usually with a median muscular bulb and a posterior non-muscular swelling, the latter sometimes not distinctly separated from the intestine.

Key to Genera.

Body of mature female of normal cylindrical shape	ANGUILLULINA, p. 226.
Body of mature female ovoid or subglobular.	HETERODERA, p. 231.

1. Genus **ANGUILLULINA** Gervais and v. Beneden, 1859.

Synonyms:—[*Anguina* Scopoli, 1777]; *Tylenchus* Bastian, 1865; *Tylenchus* Bastian, 1865; *Eutylenchus* Cobb, 1913; *Atylenchus* Cobb, 1913; *Tylenchorhynchus* Cobb, 1913; *Dolichodorus* Cobb, 1914; *Iotonchium* Cobb, 1920; *Aphelenchulus* Cobb, 1920; *Parasitylenchus* Micoletzky, 1922; *Paratylenchus* Micoletzky, 1922; *Chitinotylenchus* Micoletzky, 1922.

Cuticle striated, without bristles. Lateral alæ often present. Head usually without definite lips, but typically with six radiating ridges and six small papillæ on its anterior surface. Cephalic bristles absent. Lateral organs unknown. Stylet consists of three rods fused throughout, with distinct knobs posteriorly. Caudal end of male usually with alæ. One or two accessory pieces generally present. Testis single. Female genital tubes paired, opposed; the posterior may be rudimentary and without ovary. Caudal glands and spinneret absent. Worms chiefly in soil, especially on the roots of plants. Some species occur in fresh water or decaying substances, or in the sea. Many are plant-parasites, a few parasites or semi-parasites of insects.

Genotype:—*Anguillulina tritici* (Steinbuch, 1799).

Key to Species.

Œsophagus without distinct median bulb.	<i>cecidoplastes</i> , p. 231.
Œsophagus with a distinct median bulb	1.
1. Spicules of male more than 0.03 mm. long.	<i>tritici</i> , p. 226.
Spicules of male less than 0.03 mm. long	2.
2. Spicules about 0.016 mm. long	<i>pratensis</i> , p. 230.
Spicules about 0.02 mm. long	3.
3. Stylet about 0.02 mm. long	<i>similis</i> , p. 228.
Stylet about 0.01 mm. long	<i>angusta</i> , p. 229.

1. **Anguillulina tritici** (Steinbuch, 1799) Gervais and v. Beneden, 1859. (Fig. 112.)

Synonyms:—*Vibrio tritici* Steinbuch, 1799; *Rhabditis tritici* Dujardin, 1845; *Anguillula graminearum* Diesing, 1851 (part); *Anguillula tritici* Davaine, 1857; *Tylenchus tritici* Bastian, 1865; *Anguillula scandens* Schneider, 1866; *Tylenchus scandens* Romanin, 1867.

Habitat:—This species lives partly in the soil and partly on the stems and ears of wheat and other species of *Triticum*, or occasionally of barley. Its distribution is almost worldwide, and includes India.

The male measures about 2–2.5 mm. in length and 0.07–0.1 mm. in maximum thickness, the female 3–5 mm. and 0.1–0.2 mm. respectively. The head is narrower than the body, from which it is separated by a constriction. On its anterior surface there are six radiating ridges and six minute papillæ. The stylet, in the female, is 0.01 mm. long. The œsophagus measures 0.15–0.2 mm. in length. It consists of an anterior portion ending in a muscular bulb, a narrow

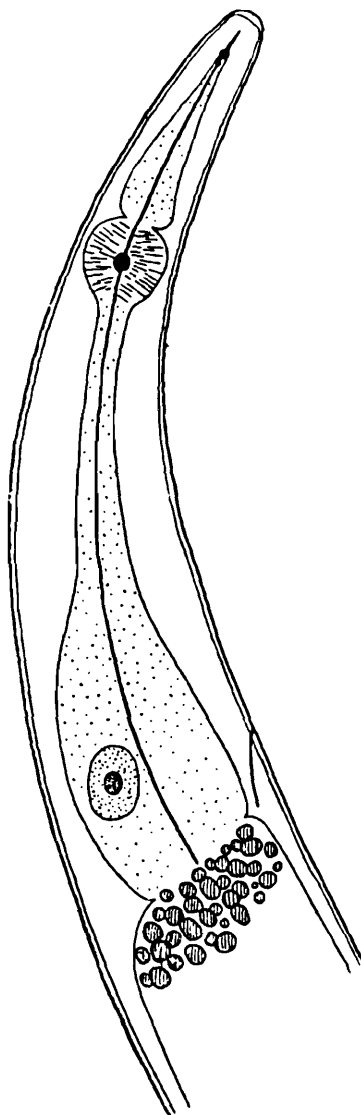

Fig. 112.—*Anguillulina tritici*. Anterior end; lateral view. (After Marcinowski.)

“neck,” about as long as the anterior portion, and usually curved in a sigmoid manner, and a swollen posterior portion containing three large unicellular glands. Of these the largest is posterior and has a large nucleus, while the two anterior cells have small nuclei. The nerve-ring surrounds the “neck” of the œsophagus, and the excretory pore is at the level of the posterior swelling.

The tail, in both sexes, is conical and about 0.1 mm. long. In the male there are well-developed caudal alæ, extending from a point somewhat in front of the roots of the spicules almost to the tip of the tail, and reaching their greatest width at the level of the cloacal aperture. The spicules measure 0.035–0.04 mm. in length, and are broad in the middle. The accessory piece is 0.018 mm. long. The testis is doubled once or twice upon itself.

The vulva is situated at about the posterior tenth of the total length, and has prominent lips. The anterior genital tube is well developed, and its ovary is usually doubly reflexed. The posterior tube is rudimentary and reduced to a short, blind sac, without an ovary. The average dimensions of the eggs, according to Goodey (1932, *b*; 1933), are 0.085×0.038 mm., but they may attain a length of 0.13–0.14 mm. and a width of 0.033–0.063 mm.

The life-history of this species is briefly as follows. The second-stage larvæ living in the soil climb on to the seedlings of the host-plant and up to the growing point. Their attacks on the tissues of the plant cause various malformations of the leaves and stem. When the inflorescence is formed they penetrate into its tissues and cause the formation of galls ("cockles") while it is still green. Within the galls they develop into adult worms, and the numerous eggs laid by the females hatch in this situation. The larvæ then moult and become second-stage larvæ. On the drying of the ear the galls become hard and dark brown in colour. The contained second-stage larvæ are extremely resistant to desiccation and are capable of living in dried galls for nine or ten years, in a state of suspended animation, and of becoming active and invading fresh plants when revived by moisture. When the galls fall to the ground and become moistened they decay, and the larvæ escape from them and enter the soil, where they remain until an opportunity occurs of attacking a fresh crop of seedlings.

2. *Anguillulina similis* (Cobb, 1893) Goodey, 1932.

Synonyms :—*Tylenchus similis* Cobb, 1893; *Tylenchus acutocaudatus* Zimmermann, 1898; *Tylenchus biformis* Cobb, 1909.

Habitat :—This species lives partly in the soil and partly as an external parasite on various plants, including several of economic importance, such as tea, coffee, bamboo and sugarcane. It is widely distributed in tropical and subtropical regions, and has been recorded in South India.

In the following characterization some of the measurements are taken from descriptions given by Cobb, Godfrey and

Goodey, while others have been calculated from Cobb's "formulæ."

The male measures 0.654–0.73 mm. in length and about 0.02 mm. in thickness, the female 0.676–0.7 mm. and about 0.027 mm. respectively. The head, in the male, is almost hemispherical and is marked off by a deep constriction. In the female it is flattened and followed by a shallow constriction. The stylet apparently measures about 0.017–0.021 mm. in length. The œsophagus is 0.126 mm. long. The three cells of its posterior, glandular part, which is dorsal to the intestine, lie in line.

In both sexes the tail is bluntly conical. The caudal alæ of the male are similar to those of *A. tritici*. There is a pair of lateral postanal papillæ at about the anterior third of the tail. These do not reach the edges of the alæ. The spicules measure about 0.02 mm. in length. Their tips are rather blunt, and their roots are knob-like and marked off by a constriction. The accessory piece is about 0.01 mm. long.

The vulva is situated slightly behind the middle of the body (at 59 per cent. of the total length from the anterior end, according to Cobb). The female genital tubes are paired and short, and both ovaries are outstretched.

3. *Anguillulina angusta* (Butler, 1913) Goodey, 1932.

Synonym :—*Tylenchus angustus* Butler, 1913.

Habitat :—This species lives in the soil or water of paddy-fields in the Ganges Delta, Eastern Bengal and Malaya, and attacks rice-plants, in which it produces a diseased condition called "ufra."

The male measures 0.6–1.1 mm. in length and 0.014–0.019 mm. in thickness, the female 0.7–1.23 mm. and 0.015–0.022 mm. respectively. The head is flattened and discoidal, and bears on its anterior surface six radial ridges. The cuticular striations are about 1.5μ apart. The stylet is 0.01 mm. long. The œsophagus measures 0.13–0.15 mm. in length and has a slender "neck" region. Its structure is similar to that in *A. tritici*.

The tail, in both sexes, is conical and has a small terminal spike. In the male it is 0.034–0.048 mm. long. The caudal alæ are of the typical form. The spicules measure 0.02 mm. in length. The basal portion of each spicule, for about one-third of the total length, is broad and somewhat oblong in shape. The rest of the spicule tapers gradually to a pointed tip. The accessory piece is 0.008 mm. long.

The tail of the female measures 0.045–0.052 mm. in length. The vulva is situated at the posterior fifth of the body, and has

rounded, slightly prominent lips. The anterior genital tube has an outstretched ovary. The posterior tube, or "uterine sac," is without an ovary, but is fairly well developed, extending for nearly two-thirds of the distance from the vulva to the anus. The eggs measure $0.08-0.088 \times 0.016-0.02$ mm.

According to Butler the worms probably multiply on the host-plant, and there may be at least three generations between June and November.

4. *Anguillulina pratensis* (de Man, 1881) Goffart, 1929.

Synonyms:—*Tylenchus pratensis* de Man, 1881; *Tylenchus gulosus* Kühn, 1889; *Tylenchus coffeæ* Zimmermann, 1898; *Tylenchus penetrans* Cobb, 1917; *Aphelenchus neglectus* Rensch, 1924; *Tylenchus brachyurus* Godfrey, 1929.

Habitat:—This species occurs in the soil in various parts of the world, including Europe, North America and the East Indies. It attacks the roots of grasses, cereals and a large variety of other plants, including beet, cabbage, coffee, sugarcane, maize, flax, tobacco, cotton and bamboo. Goodey (1933) records it from South India. The writer is indebted to Dr. Goodey for the information that in this instance the host-plant was coffee and the locality Mysore State. The adult worms, larvæ and eggs may be found together in the tissues of the plants attacked.

The synonymy given above has been taken from Goodey (1933), from whose description the following characters are also extracted. The male measures $0.45-0.64$ mm. in length and $0.02-0.028$ mm. in maximum thickness, the female $0.047-0.07$ mm. and $0.021-0.032$ mm. respectively. The body is comparatively stout and tapers little towards the ends. The cuticular striations are rather coarse. The head is marked off by a slight constriction. It has a slightly depressed anterior surface, on which there are six radiating ridges, and convex sides. Its cuticle has fine transverse striations. The stylet measures $0.013-0.015$ mm. in length in the male and $0.015-0.019$ mm. in the female. The œsophagus, in both sexes, is $0.1-0.12$ mm. long. There is a distinct constriction immediately in front of the muscular bulb. The posterior, glandular region lies ventrally to the anterior part of the intestine. Its three cells lie in line, and the posterior cell ends in a blunt point.

The tail of the male is $0.018-0.02$ mm. long. The caudal alæ have crenate edges and are continued round the tip of the tail. There is a single pair of lateral papillæ at about the middle of the tail, terminating in depressions in the alæ. The spicules measure $0.016-0.0162$ mm. and the accessory piece 0.005 mm. in length.

The tail of the female is bluntly rounded and 0.02–0.022 mm. long. The vulva is situated at about the posterior fifth of the total length, and has rounded and sometimes prominent lips. The posterior branch of the uterus is very short and without an ovary. The anterior ovary is not reflexed. The uterus contains only one egg at a time. The eggs measure 0.063–0.08 × 0.021–0.025 mm.

5. *Anguillulina cecidoplastes* Goodey, 1934.

Habitat:—In galls on the leaves and stems of a grass (*Andropogon pertusus*); South India (Bangalore, Chikmagalur, Coimbatore, Palghat).

The male measures 0.97–1.33 mm. in length, the female 1.2–2.03 mm. “The head has the shape of a flat cap and is separated from the body by a faint constriction.” It bears six radiating ridges. The stylet measures 0.008–0.009 mm. in length. The œsophagus, which is about 0.2 mm. long, differs from that of typical members of the genus in having no distinct median muscular bulb. It consists of an anterior fusiform portion and a posterior club-shaped glandular swelling, composed of a large dorsal cell and two smaller subventral cells with smaller nuclei. The nerve-ring is situated just in front of the glandular swelling, and the excretory pore at about the level of its middle.

The tail, in both sexes, is tapering, with a “minute peg-like terminal process.” In the male there are very narrow caudal alæ, extending from a short distance in front of the roots of the (retracted) spicules to about the middle of the tail. The spicules measure 0.028–0.03 mm. in length and are rather stout, with a slight constriction separating the root from the rest of the tubular shaft, and each has a thin membranous ala on the ventral side. There is apparently no accessory piece. The testis is doubled once upon itself.

The vulva is situated at about the posterior tenth of the body. The anterior genital tube is well developed and doubled twice upon itself; the posterior reduced to a short, blind sac. The uterus may contain as many as five eggs at a time.

2. Genus **HETERODERA** Schmidt, 1871.

Synonyms:—*Meloidogyne* Göldi, 1889; *Heterobolbus* Railliet, 1896; *Caconema* Cobb, 1924.

Male of typical cylindrical shape. Body of mature female becomes swollen into an ovoid or subglobular shape, only the neck region remaining normal. The tail disappears in the adult female, its place being taken by a terminal prominence carrying the vulva, and the anus becomes terminal

or dorsal. Cuticle striated, without bristles. Head rather distinct, with six lips. Lateral organs indistinct or absent. Stylet composed of three rods, fused throughout and knobbed behind. Posterior portion of œsophagus not distinct from intestine. A median muscular bulb present. Excretory system consists of a lateral canal on the left side only. Caudal end of male without alæ or papillæ. Spicules equal, short and broad. An accessory piece present. Testis, in the genotype, single, anterior, outstretched. Female genital tubes paired, parallel, anterior, elongate and sinuous. Oviparous. Worms in soil, or attached to or buried in the roots of plants.

Genotype :—*Heterodera schachtii* Schmidt, 1871.

1. ***Heterodera marioni*** (Cornu, 1879) Goodey, 1932. (Fig. 113.)

Synonyms :—*Anguillula marioni* Cornu, 1879; *Tylenchus radicola* Örley, 1880; *Anguillula radicola* Müller, 1884, nec *Anguillula radicola* Greeff, 1872; *Heterodera radicola* Müller, 1884; *Heterodera javanica* Treub, 1885; *Anguillula arenaria* Neal, 1889; *Tylenchus arenarius* Cobb, 1890; *Meloidogyne exigua* Göldi, 1892; *Heterodera (Heterobolbus) radicola* Julien, 1898; *Anguillula vialæ* Lavergne, 1901; *Oxyuris incognita* Kofoid and White, 1919; *Caconema radicola* Cobb, 1924; *Heterodera (Caconema) radicola* Cobb, 1924.

Habitat :—The adult worms are found within the tissues of the roots of plants. The larvæ occur in the same situation and also in the soil. The species of plants attacked are very numerous and belong to many orders. They include many plants of economic importance, such as the potato, tomato, bean, pea, wheat, barley, clover, sugar-cane, banana, tea, coffee, cocoa, rubber and hemp. The distribution of the worm is world-wide, and includes India and Ceylon.

The male measures about 1.2–1.5 mm. in length and 0.03–0.036 mm. in thickness. The dimensions of the mature female are extremely variable. The average size appears to be about 0.8 mm. long and 0.5 mm. wide, but different authors give measurements varying from 0.3 to 1.3 mm. in length and from 0.08 to 0.75 mm. in width. The neck region of the female is about 0.24 mm. long. The stylet measures 0.018–0.02 mm. in length in the male and 0.01–0.012 mm. in the female. The cuticular striations, in the male, are at intervals of 2–2.5 μ .

The spicules measure 0.035 mm. and the accessory piece 0.01–0.012 mm. in length. According to Cobb the male of this species differs from that of the genotype in having paired testes.

The anus of the female is subterminal. The vulva is not prominent. The eggs, when laid, are embedded in a gelatinous mass which remains attached to the parent worm. Some may,

however, remain within the body and hatch there. Parthenogenetic reproduction seems to be the rule, males appearing only exceptionally. The size of the eggs is very variable. Different authors give 0.067–0.128 mm. as the length and 0.028–0.08 mm. as the width. The average dimensions are said to be 0.092×0.038 mm. The larvæ, on hatching, measure 0.375–0.5 mm. in length and 0.012–0.015 mm. in thickness.

The roots of plants attacked by this worm usually become thickened locally, and galls are formed on them where the

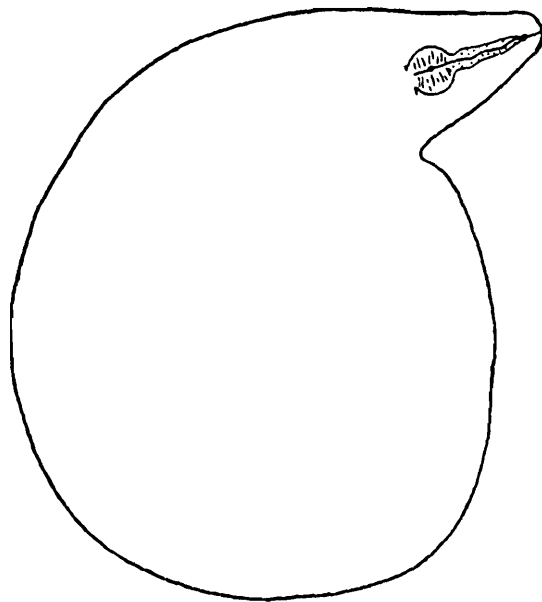

Fig. 113.—*Heterodera marioni*. Outline of female. (After Marcinowski.)

worms are most numerous. The adult worms remain completely buried in the tissues. The eggs are laid and hatch within the galls. They may remain in the root of the plant and give rise to another generation, or may find their way out into the soil, in which they are capable of living for about a year before entering a plant again.

Subfamily DORYLAIMINÆ Baylis and Daubney, 1926.

Œsophagus without median bulb, but usually with a more or less distinct posterior swelling, which sometimes forms a bulb.

Key to Genera.

Cuticle not conspicuously striated; stylet not knobbed behind	[p. 234.
DORYLAIMUS,	
Cuticle with wide annulations; stylet absent in adult male, knobbed behind in female	[p. 235.
HOPLOLAIMUS,	

1. Genus **DORYLAIMUS** Dujardin, 1845.

Synonyms :—*Antholaimus* Cobb, 1913 ; *Nygolaimus* Cobb, 1913 ; *Actinolaimus* Cobb, 1913 ; *Discolaimus* Cobb, 1913 ; *Dorylaimellus* Cobb, 1913 ; *Axonchium* Cobb, 1920 ; *Doryllium* Cobb, 1920 ; *Longidorus* Micoletzky, 1922.

Cuticle usually unstriated, without lateral alæ or bristles. Head separated by a constriction from the body, and usually with six lips, each bearing two papillæ, but without bristles. Lateral organs inconspicuous, probably usually slit-like. Stylet tubular, not knobbed behind. Œsophagus swollen behind but without distinct bulb. Caudal end of male typically with a median row of preanal papillæ. Postanal papillæ usually present in both sexes. Spicules fairly stout. Two rod-like accessory pieces usually present, closely applied to the spicules. Testes paired, opposed, outstretched. Female genital tubes almost always paired, opposed, reflexed ; occasionally single, posterior. Caudal glands and spinneret absent. Worms in soil or fresh water, on plants, or in decaying substances.

Genotype :—Probably *Dorylaimus stagnalis* Dujardin, 1845, according to Stiles and Hassall (1905).

1. **Dorylaimus palustris** (Carter, 1858) Bastian, 1865.

Synonym :—*Urolabes palustris* Carter, 1858.

Habitat :—Island of Bombay ; in fresh water in pools, tanks and drains, or “ wherever there is vegetable matter, mud, and putrescency, and in the gelatinous algæ during the ‘ rains ’ ” (Carter, 1859).

Carter refers to this species as the “ tank-worm.” Most of its characters, as given by him, are of generic rather than specific value. The largest specimens are one-sixth of an inch long (approximately 4·2 mm.), and the thickness of the female is 1/370 in. (about 0·07 mm.) The head has “ at least two, if not four ” indistinct papillæ. The tail of the male is so obtuse as to be almost truncate. That of the female is whip-like, “ varies in length, and becomes curved upon itself when short.” The vulva is situated a little in front of the middle of the body.

2. **Dorylaimus** sp. Stewart, 1914.

Habitat :—Fresh water, in sponges (*Suberites aquæ-dulcioris*, *Spongilla* sp.); Chilka Lake.

The male measures 1·87–2 mm. in length and 0·041–0·044 mm. in thickness, the female 1·938 mm. and 0·055 mm. respectively. The head is rounded and narrower than the

neck. It measures 0.012–0.015 mm. in width. There are “no lateral organs, but a pair of tubular organs in the dorsal and ventral lines distant 0.008 mm. from the head; opening of tubule slightly prominent; tubule runs inward and backward.” The stylet is 0.024 mm. long. The œsophagus measures 0.377–0.425 mm. in length, and is divided by a “diaphragm” into anterior and posterior portions of subequal length. The posterior portion is slightly wider, and has coarser musculature, than the anterior. Its hinder part is glandular and measures 0.03 mm. in diameter. The nerve-ring is situated at 0.037–0.04 mm. from the anterior end of the œsophagus.

The tail, in both sexes, is short and bluntly rounded. The posterior end of the male is without preanal papillæ, but there is one short preanal bristle. The tail is 0.022 mm. long. The spicules are “very broadly sabre-shaped” and measure 0.037 mm. in length.

The tail of the female is 0.018 mm. long. The vulva is situated at 0.85 mm. from the anterior extremity. The eggs are elongate and subcylindrical.

2. Genus **HOPLOLAIMUS** Daday, 1905.

Synonyms :—*Iota* Cobb, 1913; *Criconema* (also *Krikonema*) Hofmänner and Menzel, 1914; *Ogma* Southern, 1914.

Cuticle with wide, often prominent annulations, sometimes forming series of “scales” or spines, but without bristles. Lateral alæ absent. Head sometimes distinct. Lips usually poorly developed. Six cephalic papillæ or bristles may be present. Lateral organs unknown. Stylet very long, more or less obviously formed of three rods, and knobbed behind. Stylet of male appears to be lost at the last moult. Male (when known) with two spicules, without accessory piece or caudal papillæ, and with a single, anterior, outstretched testis. Female with either a single, anterior genital tube or paired, opposed, outstretched genital tubes. Oviparous and probably usually hermaphrodite. Caudal glands and spinneret absent. Anus sometimes absent in female. Adult worms in fresh water or soil.

Genotype :—*Hoplolaimus tylenchiformis* Daday, 1905.

1. **Hoplolaimus squamosus** (Cobb, 1913) Menzel, 1917

Synonym :—*Iota squamosa* Cobb, 1913.

Habitat :—On roots of mango; Bangalore.

The length of the body, in both sexes, is 0.8 mm. The other measurements in the following description have been obtained by calculation from Cobb’s “formula.” The maximum

thickness is 0.032 mm. in the male and 0.058 mm. in the female. The cuticle of the body is marked by about 150 annulations, each consisting of eight "scales." The stylet is 0.12–0.144 mm. long. Its width is one-third of that of one of the annulations, increasing to twice this width in its posterior quarter. Its bulbous base is one-third as wide as the neck of the worm. The excretory pore is situated at 0.16 mm., or rather more, from the anterior end in the female.

The tail bears nine annulations. In the male it is 0.048 mm. long. The spicules are 0.043 mm. long, slender, tapering in their distal two-thirds, and sharply pointed. The tail of the female is 0.032 mm. long. The vulva is situated at 0.048 mm. (between the twelfth and thirteenth annulations) from the posterior end. There is a single, anterior, reflexed genital tube.

9. Family TRILOBIDÆ Micoletzky, 1922.

Free-living forms, mostly marine, with a distinct buccal cavity without teeth. Œsophagus typically without a true muscular posterior bulb containing valves, but slightly expanded behind. Reproductive organs simple. Sexes generally distinct. Mostly oviparous, producing few and large eggs.

Key to Genera.

Buccal capsule cup-shaped	MONHYSTERA, p. 236.
Buccal capsule prismoid .	FIMBRILLA, p. 238.
Buccal capsule "fiddle-shaped"	SYMPLOCOSTOMA, p. 239.

1. Genus **MONHYSTERA** Bastian, 1865.

Synonyms :—*Monohystera* de Man et auctt. ; *Tachyhodites* Bastian, 1865 ; *Theristus* Bastian, 1865 ; *Penzancia* de Man, 1889 ; *Austronema* Cobb, 1914 ; *Paramonohystera* Steiner, 1916 ; *Steineria* Micoletzky, 1922, nec Filipjev, 1922 ; *Allomonhystera* Micoletzky, 1923.

Cuticle smooth or striated, usually with bristles, irregularly distributed or in submedian rows. Lateral alæ absent. Head generally with indistinct lips, almost always with bristles. Lateral organs usually circular. Buccal capsule very small, thin-walled, saucer- or cup-shaped, its walls continuous with the œsophageal lining. Œsophagus cylindrical, usually slightly expanded posteriorly, without distinct bulb. Ocelli sometimes present in aquatic forms. Male with two equal spicules and usually an accessory piece, the latter commonly with a posterior process. Testis generally single. Female genital tube usually

single, anterior, outstretched. Mostly oviparous. Parthenogenesis common in non-marine forms. Caudal glands and spinneret usually present. Worms aquatic (marine and freshwater) or terricolous.

Genotype :—*Monhystera stagnalis* Bastian, 1865.

Key to Species.

Head surrounded by a crown of six bristles
Head surrounded by a membranous collar

megalaima, p. 237.
uria, p. 237.

1. *Monhystera megalaima* Stewart, 1914.

Habitat :—Among filamentous algæ at the edge of Chilka Lake, at Gantasila.

The male measures 0.765 mm. in length and 0.025 mm. in maximum thickness, the female 1.3 mm. and 0.044 mm. respectively. The body tapers only very slightly towards the head, but is gradually tapering posteriorly. The cuticle is finely striated throughout, and bears, in the female, a few irregularly scattered bristles. These are very long (0.02 mm.), slender and sometimes spirally curled. No bristles were seen on the body in the male. The head is marked off by a slight constriction and surrounded by a crown of six stout bristles, 0.0136 mm. long. Within this there is a second crown of very short spines. The lateral organs are circular and relatively large, having a diameter of 8.8μ . Their anterior margins are situated at 0.0187 mm. from the anterior extremity. The buccal capsule is thin-walled and broader than long. Its length is 9μ . The œsophagus is simple and club-shaped, and measures 0.0935 mm. in length in the male and 0.21 mm. in the female. There is a transverse "diaphragm" in its musculature immediately in front of the lateral organs.

The tail of the male is blunter than that of the female, and measures 0.085 mm. in length. The spicules have knob-like roots, twisted shafts and hollow, slightly swollen tips. There is a single testis.

The tail of the female is pointed but not filiform, is curved ventrally and bears a circle of short bristles close to the tip. It measures 0.152 mm. in length. The vulva is situated at 0.284 mm. from the posterior extremity.

2. *Monhystera uria* Stewart, 1914.

Habitat :—"From the gelatinous spawn of a Eunicid worm, Rambha, Chilka Lake, Ganjam, edge of the lake."

The male measures 0.66 mm. in length and 0.019 mm. in maximum thickness, the female 0.536 mm. and 0.024 mm. respectively. The body is slightly tapering anteriorly. The head is rounded and bears "a low collar of delicate

mobile membrane around the mouth." The lateral organs are circular, about 4μ in diameter, and situated at 5.3μ from the anterior end. The buccal cavity is oval and measures 3μ in length in the male. The œsophagus is simple and club-shaped, and measures 0.092–0.093 mm. in length.

The tail is conical and filiform in both sexes, without bristles, glands or papillæ, but with a terminal flagellum. In the male it measures 0.093 mm. in length. The spicules are slender and 0.03 mm. long. There is a single testis.

The tail of the female is 0.102 mm. long. The vulva is situated at 0.222 mm. from the posterior extremity. The uterus and ovary are single. The uterus is short (0.064 mm.), and the ovary is not reflexed.

2. Genus **FIMBRILLA** Cobb, in Stiles and Hassall, 1905.

Synonym :—*Fimbria* Cobb, 1894, *nec* Megerle, 1811.

Cuticle unstriated, with bristles at least at posterior end. Head somewhat distinct, with a crown of bristles. Buccal capsule prismoid. Œsophagus expands gradually behind. Caudal end of male without alæ or supplementary organs, Two accessory pieces present, nearly as long as the spicules, joined posteriorly and protrusible. Testes paired, opposed, outstretched. Female unknown. Worms marine.

Genotype :—*Fimbrilla tenuis* (Cobb, 1894).

1. **Fimbrilla tenuis** (Cobb, 1894) Cobb, in Stiles and Hassall, 1905.

Synonym :—*Fimbria tenuis* Cobb, 1894.

Habitat :—Marine (among seaweed) ; Ceylon.

Of this species the male only is known. This measures 1.48 mm. in length and about 0.024 mm. in maximum thickness. The head is slightly expanded and rounded in front. The mouth is surrounded by minute bristles or bristle-bearing papillæ. There is a simple, prismoid buccal capsule, about 3μ long and nearly half as wide as the head. The œsophagus is 0.355 mm. long and is described as having a posterior bulb, marked off by a deep constriction. The nerve-ring is situated at about the middle of the œsophagus, with the excretory pore just behind it. The excretory gland extends posteriorly behind the bulb of the œsophagus.

The tail is about 0.104 mm. long, has a slightly swollen tip and is covered with hairs in its posterior two-thirds. The spicules are slender, nearly straight and pointed. They measure about 0.013 mm. in length. The measurements in the foregoing description, except the length of the worm, have been calculated from Cobb's "formula."

3. Genus **SYMPLOCOSTOMA** Bastian, 1865.

Cuticle without striations or bristles. Head not distinct, with or without bristles. Lateral organs unknown. Pharynx elongate, "somewhat fiddle-shaped, having a peculiar funnel-shaped body lying along its inferior aspect, and an appearance of three or more circular lines around the parietes." Œsophagus widening considerably but gradually behind, without bulb. Ocelli present or absent. Caudal end of male apparently without supplementary organs or papillæ. Accessory piece absent. Female genital tubes paired, opposed. Caudal glands and spinneret present. Worms marine.

Genotype:—*Symplocostoma longicolle* Bastian, 1865.

Note.—This genus was only tentatively proposed by Bastian, and its validity and its position in the family Trilobidæ are somewhat uncertain.

1. **Symplocostoma barbatum** (Carter, 1859) Bastian, 1865, *emend.*

Synonyms:—*Urolabes barbata* Carter, 1859; *Enoplus barbatus* Eberth, 1863; *Symplocostoma barbata* Bastian, 1865.

Habitat:—"Silty clots of *Oscillatoria* floating in the salt-water main drain of the town of Bombay."

Bastian places this species rather doubtfully in the genus *Symplocostoma*. No description of it is available except that of Carter, from which the following characters are taken.

The length of the worm is $\frac{1}{7}$ in., and its thickness $\frac{1}{600}$ in. (approximately 3.6 mm. and 0.04 mm. respectively). The head bears four short bristles. There is a pair of yellow ocelli at about the middle of the œsophagus.

The tail of the male is thick, curved, blunt, "tuberculated in its inner curvature, and furnished on each side with a row of short setæ extending from above the anus towards the tip; also three or four setæ on the outer curvature." The spicules are broad and curved.

The vulva is situated at about the posterior third of the body.

10. Family ALAIMIDÆ Micoletzky, 1922.

Free-living forms, mostly marine, but sometimes terricolous or freshwater. Buccal cavity absent or extremely small. Œsophagus generally without a true muscular bulb containing valves. Reproductive organs simple. Sexes generally distinct. Oviparous, producing few and large eggs.

1. Genus **DIPLOPELTIS** Cobb, in Stiles and Hassall, 1905.

Synonym :—*Dipeltis* Cobb, 1891, *nec* Packard, 1885.

Cuticle very finely striated, with or without conspicuous bristles. Head with three lips, of which one is more pointed than the others, and spear-like. In the genotype there are four submedian rows of about twelve stout bristles on the neck. Lateral organs with a thickened margin, more pointed in front than behind and extending to the base of the lips. The very small buccal capsule "seems to be armed with a minute labial spear." Œsophagus club-shaped. Ocelli sometimes present. An accessory piece present, with a posterior process. Testes apparently paired and opposed. Female genital organs unknown. Caudal glands present. Worms marine.

Genotype :—*Diplopeltis typicus* (Cobb, 1891).

1. **Diplopeltis minor** (Cobb, 1891) Cobb, in Stiles and Hassall, 1905.

Synonym :—*Dipeltis minor* Cobb, 1891.

Habitat :—Marine ; in sand on the coast of Ceylon.

Cobb's description of this species is based on a single male specimen. This was 1.26 mm. long. The rest of the measurements in the following description have been obtained by calculation from Cobb's "formula." The maximum thickness is about 0.03 mm. The head is "almost acute." The lateral organs are ellipsoidal, and their length is "one-fifth as great as the distance between the mouth and the nerve-ring." The cuticle is without conspicuous bristles. The Œsophagus is about 0.24 mm. long. "The portion of the alimentary canal immediately behind the distinct cardiac collum is usually pressed to one side by the large ventral gland, which is two-thirds as wide as the body and twice as long as wide." The nerve-ring is situated at about 0.1 mm. from the anterior end.

The tail is 0.1 mm. long and is provided with a spinneret. The spicules are filiform, curved and of nearly equal thickness throughout. They are about 0.024 mm. long. "An accessory piece less than half as long as the spicula is seen to curve inward and backward from the anus."

11. Family ONCHOLAIMIDÆ Baylis and Daubney, 1926.

Typically small, free-living forms with a buccal cavity having chitinoid walls and containing usually three teeth, of which one is dorsal and two subventral. One or more of the teeth may be absent, or additional teeth or denticles may be developed. Œsophagus with or without a posterior bulb.

Subfamily ONCHOLAIMINÆ Micoletzky, 1922.

Pharynx typically rather spacious, containing three teeth, frequently at or near its base. One or more of the teeth may be absent, or additional teeth may be developed on the walls of the pharynx. Œsophagus typically club-shaped, exceptionally with a posterior bulb.

1. Genus **ONCHOLAIMUS** Dujardin, 1845.

Synonyms:—*Viscosia* de Man, 1890; *Metoncholaimus* Filipjev, 1918; *Adoncholaimus* Filipjev, 1918; *Prooncholaimus* Micoletzky, 1924.

Some species of relatively large size (25–30 mm.). Cuticle unstriated, sometimes glutinous. Bristles usually present on the tail, and papillæ or bristles frequently present towards both extremities. Head not distinct, with rounded lips and usually with bristles. Lateral organs transversely elliptical. Pharynx spacious, cylindrical or six-sided, containing a dorsal and two subventral teeth. One of the subventral teeth is larger than the others, and all the teeth carry the ducts of œsophageal glands. Œsophagus gradually swollen behind, without bulb. Ocelli sometimes present. A single accessory piece may be present. Testis single or paired. Female genital tubes paired and opposed, or single and anterior, always reflexed. A peculiar “tubiform organ” typically present in the body-cavity of the female, opening by paired lateral pores near the anus. Caudal glands present. Specialized spinneret apparently absent. Worms mostly marine, a few species in fresh or brackish water.

Genotype:—*Oncholaimus attenuatus* Dujardin, 1845 (?).

Key to Species.

Each lip bears a flat, spine-like process
Each lip bears a minute papilla

NEM.

indicus, p. 242.
chilkensis, p. 243.

R

1. *Oncholaimus indicus* v. Linstow, 1907. (Fig. 114.)

Habitat:—Among filamentous algæ in a pool of brackish water at Port Canning, Matla estuary, Lower Bengal (v. Linstow); also in a canal of brackish water on the outskirts of Calcutta (Stewart).

The male measures 2.43–2.71 mm. in length and 0.05–0.053 mm. in maximum thickness, the female 2–2.71 mm. and 0.057–0.068 mm. respectively. The body tapers gradually towards both ends. The cuticle is smooth. In the male there are a few bristles in the œsophageal region, and a row of nine or ten bristles in front of and behind the cloacal aperture. In both sexes there are a few bristles at the tip of the tail. The head is truncate, and there are six mobile, leaf-like, semicircular lips, each bearing a sharp, flat, spine-like process (Stewart). There are no bristles on the head.

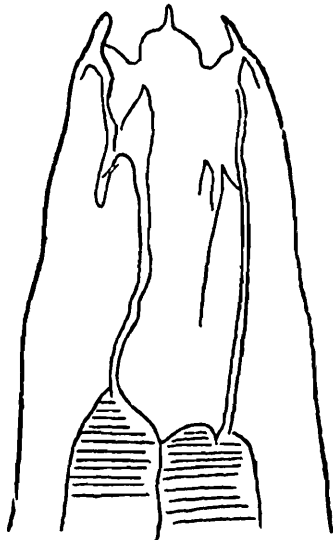

Fig. 114.—*Oncholaimus indicus*. Anterior end of female, viewed from left side. (After Stewart.)

The pharynx is cylindrical and measures 0.034–0.037 mm. in length and 0.014 mm. in diameter. In its anterior half it contains three teeth, one dorsal and two subventral. The right subventral tooth is larger and more anteriorly placed than the others. The œsophagus is 0.357–0.374 mm. long and, according to Stewart, is club-shaped, “with a small segment, also muscular, at its posterior extremity, distinctly separated from the main mass. This small segment projects into the lumen of the intestine.” The nerve-ring and excretory pore are situated, according to Stewart, at 0.0017 [? 0.017] mm. from the anterior extremity.

The tail, in both sexes, is constricted at a short distance behind the anus, and is then continued as a cylindrical appendage, 0.076–0.085 mm. long, which is bent ventrally near the tip. The length of the tail in the male is 1/25.6 of the total

length. The spicules are sabre-shaped and 0.034 mm. long. There is a hollow, conical accessory piece.

The tail of the female is 0.125–0.129 mm. long. The vulva is situated in the middle of the body, or a little behind it. The genital tubes are paired, opposed and reflexed. A “tubiform organ” has not been observed. The eggs are produced two at a time. v. Linstow gives their dimensions as 0.78 [? 0.078] × 0.047 mm. According to Stewart they measure 0.272 [? 0.072] mm. in length.

2. *Oncholaimus chilkensis* Stewart, 1914.

Habitat :—Among filamentous algæ and in *Spongilla* sp.; Chilka Lake.

The male of this species is unknown. The female measures 1.54–2.7 mm. in length and 0.057–0.074 mm. in maximum thickness. The head is marked off from the body by a slight but abrupt increase in width at the posterior end of the pharynx. There are six mobile lips (two lateral and four submedian), each bearing a minute papilla, but cephalic bristles are absent. “Hairs occur irregularly in the œsophageal region, one marked row in each lateral line in this region. No bristles at the vulva or anus.” The lateral organs are situated at 0.019 mm. from the anterior end. The pharynx is cylindrical and measures 0.032–0.039 mm. in length. The right subventral tooth is large, the dorsal and left subventral teeth smaller. The œsophagus measures 0.269–0.323 mm. in length and 0.029–0.042 mm. in maximum thickness. There are no ocelli. The nerve-ring is situated at 0.104 mm. from the anterior end of the œsophagus.

The tail is 0.136–0.15 mm. long. Its basal portion is conical, while its terminal portion is cylindrical, 0.075 mm. long and ventrally curved. At the junction of the two portions there is a very slight annular constriction. The vulva is situated at 1.14–1.45 mm. from the posterior end of the body, and the genital tubes are paired.

2. Genus **CHROMADORA** Bastian, 1865.

Synonyms :—*Acanthopharynx* Marion, 1870 (?); *Ethmolaimus* de Man, 1880; *Euchromadora* de Man, 1886; *Graphonema* Cobb, 1898; *Chromadorissa* Filipjev, 1917; *Spilophorella* Filipjev, 1917; *Chromadorina* Filipjev, 1918; *Chromadorella* Filipjev, 1918; *Spilipherella* Filipjev, 1918; *Odontocricus* Steiner, 1918; *Polysigma* Cobb, 1920; *Ptycholaimellus* Cobb, 1920; *Chromadorita* Filipjev, 1922; *Prochromadora* Filipjev, 1922; *Endolaimus* Filipjev, 1922.

Cuticle striated, usually with submedian bristles. Lateral alæ usually absent, except in marine forms. Head without lips, but with six to twelve papillæ. Submedian cephalic

bristles usually present; lateral cephalic bristles absent. Lateral organs in the form of grooves or transversely oval, rarely definitely spiral. Pharynx typically in two portions, the anterior wide, the posterior funnel-shaped. The anterior portion has longitudinal rod-like thickenings (or folds?) in its wall, and usually contains a dorsal tooth, and sometimes two subventral teeth. Œsophagus with a more or less distinct posterior swelling, but usually without a bulb. Caudal end of male with or without preanal papillæ. Postanal papillæ absent. Spicules sometimes unequal and dissimilar. Accessory piece complex, consisting of a posterior, a median and two lateral portions. Testis usually single. Female genital tubes paired, opposed, reflexed. Caudal glands present. Spinneret present or absent. Worms marine, in fresh water, or in the soil.

Genotype:—*Chromadora vulgaris* Bastian, 1865.

1. **Chromadora ocellata** (Carter, 1859) Bastian, 1865.

Synonyms:—*Urolabes ocellata* Carter, 1859; *Phanoglene ocellata* Eberth, 1863.

Habitat:—"Silty clots of *Oscillatoria* floating in the salt-water main drain of the town of Bombay."

The only description of this species available is the very inadequate account given by Carter, and it is doubtful whether the species can be recognized. Bastian considered it to be a *Chromadora*. The length of the worm is given as about 1/32 in. [0.78 mm.]. The head is blunt and bears four short bristles. There is no pharynx, according to Carter's figure. The Œsophagus is figured as expanding rather suddenly into a bulb-like swelling behind. A pair of reddish ocelli is present. The tail is short and somewhat curved, and has a pointed terminal spike. The spicules are broad.

Subfamily DESMODORINÆ Baylis and Daubney, 1926.

Pharynx variable in shape, typically containing a single forwardly-directed (dorsal) tooth. Œsophagus with or without a posterior bulb.

1. Genus **THORACOSTOMA** Marion, 1870.

Synonyms:—*Hemipsilus* de Quatrefages, 1846; *Deontostoma* Filipjev, 1916; *Jägerskiöldia* Filipjev, 1916; *Leptosomatides* Filipjev, 1918.

Cuticle finely striated, without bristles except in the cervical region and in the caudal region of the male. Head not

distinct, but narrowed, with two crowns of bristles and covered by a specialized cuticular cap. Pharynx short, three-sided, containing a dorsal tooth which may be simple or bilobed. Œsophagus without bulb. Ocelli present, sometimes furnished with lenses. Caudal end of male with several pairs of ventral preanal and postanal bristles. There may be a single median preanal supplementary organ and two rows of submedian supplementary organs. A bipartite accessory piece present. Testes opposed, outstretched. Female genital tubes paired, opposed, reflexed. Caudal glands and spinneret present. Worms marine.

Genotype :—*Thoracostoma echinodon* Marion, 1870 (?).

1. *Thoracostoma indicum* (Stewart, 1914).

Synonym :—*Leptosomatum indicum* Stewart, 1914.

Habitat :—“ Manikpatna, outer channel of Chilka Lake from Algæ on an oyster-shell.”

Stewart's description, which was based on a single male specimen, seems to suggest a species of *Thoracostoma* rather than of *Leptosomatum*. The worm, according to Stewart, is 5 mm. long and measures 0.088 mm. in maximum thickness. The head is rounded and 0.033 mm. wide, and bears a crown of four short and stout hairs. The mouth is surrounded by a membranous ring. “A cap of yellow cuticular substance lies under the cuticle of the head, the base of the cap reaching to a distance of 0.022 mm. from the anterior extremity. The cap when seen in optical section presents the appearance of distinct skeletal pieces.” The cuticle of the body is smooth and bears no hairs. The lateral organs are spherical capsules with oval pores. The nearly cylindrical Œsophagus measures 0.799 mm. in length and 0.033 mm. in greatest thickness. There is a pair of black ocelli, with a tinge of red, situated at 0.56 mm. from the anterior end. The nerve-ring is situated at 0.289 mm. from the same point.

The tail is bluntly rounded and measures 0.078 mm. in length. The lips of the cloacal aperture are slightly prominent. There is a median papilla at 0.071 mm. in front of the aperture. Three tubular caudal glands are present. Their duct is dilated to form a “biscuit-shaped” ampulla. The spicules are broad and hollow, and measure 0.088 mm. in length. There is a single accessory piece.

Order STRONGYLOIDEA Weinland, 1858.

Parasitic forms in which the mouth is of varying structure, but never has three distinct lips. A buccal capsule frequently present. Œsophagus more or less club-shaped, without a posterior bulb. Males with a terminal or subterminal caudal bursa, supported by a system of rays consisting typically of six bilaterally symmetrical pairs and a median unpaired dorsal ray with accessory branches.

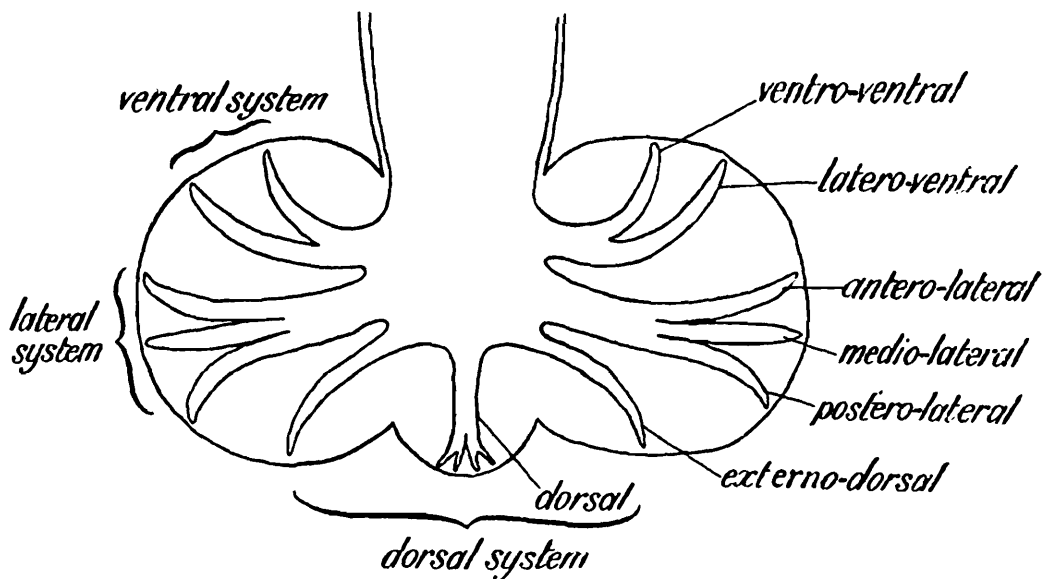

Fig. 115.—Diagram of the bursa of the Strongyloidea. (After Baylis.)

The general arrangement of the rays of the bursa is constant throughout the group, though it may be more or less masked in certain forms (*Metastrongylidæ*) in which they are much reduced. Their arrangement, and the nomenclature here adopted for them, will be best understood from the accompanying diagram (fig. 115).

12. Family STRONGYLIDÆ Baird, 1853.

Medium-sized or rather small parasitic forms in which there is a well-developed buccal capsule in the adults. The anterior margin of the capsule is without tooth-like structures or cutting-plates, but is usually guarded by a circular fringe of leaf-like or bristle-like cuticular elements, known as a *corona radiata* or "leaf-crown." There is frequently one such leaf-crown at the entrance to the buccal capsule and another

springing from within its walls a little further back. In this case the former is referred to as the external and the latter as the internal leaf-crown. From the possession of these palisade-like fringes some of the Strongylidæ have received the name of "palisade-worms."

The bursa of the male is well developed, and the rays, as a rule, show little departure from the typical arrangement. In some genera the dorsal lobe is exceptionally highly developed, and the dorsal ray becomes complicated by the development of accessory branches.

The life-history, so far as is known, is always direct. The females are oviparous.

Subfamily STRONGYLINÆ Railliet, 1893.

Buccal capsule relatively large, more or less subglobular or funnel-shaped. The dorsal gutter (a median longitudinal thickening in the dorsal wall of the capsule, carrying the terminal duct of the dorsal œsophageal gland) is usually well developed and extends nearly to the anterior margin of the capsule. Worms parasitic in the alimentary canal of vertebrates.

Key to Genera.

Parasite of a bird (<i>Rhea</i>)	DELETROCEPHALUS,
Parasites of the horse tribe and elephants	1. [p. 261.
1. Buccal capsule with dorsal gutter	2.
Dorsal gutter apparently absent.	4.
2. Elements of external leaf-crown of two lengths	EQUINURBIA, p. 258.
Elements of external leaf-crown of uniform length	3.
3. Buccal capsule with two or four teeth at its base, or without teeth	STRONGYLUS, p. 247.
Buccal capsule with six teeth at its base.	TRIODONTOPHORUS,
4. Buccal capsule goblet-shaped, with a circular ridge posteriorly.	[p. 253.
Buccal capsule elongate, narrowing posteriorly	ÆSOPHAGODONTUS, [p. 256.
	CHONIANGIUM, p. 259.

1. Genus STRONGYLUS Müller, 1780.

Synonyms :—*Sclerostoma* Rudolphi, 1809, et auctt. ; *Sclerostomum* auctt.

Elements of external leaf-crown numerous. Internal leaf-crown may be rudimentary or absent. Buccal capsule more or less cup-shaped, thick-walled, with an external cuticular ridge immediately behind its anterior border. Teeth may be present towards the base of the capsule. Dorsal gutter well

developed. Bursa of male small, entire. Spicules not barbed. Uterine branches opposed. Adults in the large intestine of Equidæ and elephants.

Genotype :—*Strongylus equinus* Müller, 1780, of Looss, 1900.

Key to Subgenera.

Buccal capsule without teeth	ALFORTIA, p. 250.
Buccal capsule with teeth near its base	1.
1. Teeth four	STRONGYLUS, p. 248.
Teeth two .	2.
2. Teeth dorsal .	DELAFONDIA, p. 251.
Teeth subventral ..	DECRUSIA, p. 251.

Subgenus **STRONGYLUS** Railliet, 1923.

Buccal capsule with two dorsal and two subventral teeth at its base. Genital cone of male well developed. An accessory piece present. Adults parasitic in Equidæ.

Type-species :—*S. (Strongylus) equinus* Müller, 1780, of Looss, 1900.

1. **Strongylus (Strongylus) equinus** Müller, 1780, of Looss, 1900.
(Fig. 116, A.)

Synonyms :—*Strongylus equinus* Müller, 1780 (part); *Strongylus equorum* Zeder, 1800 (part); *Strongylus armatus* Rudolphi, 1802 (part); *Strongylus armatus major* Rudolphi, 1809; *Sclerostoma equinum* de Blainville, 1828, Looss, 1900; *Strongylus neglectus* Poeppel, 1897; ? *Strongylus asininus* Viborg, 1795; ? *Piguris armatum* Ward, 1895.

Hosts :—This species occurs in the colon and cæcum of the horse, donkey, mule and zebra, almost wherever these animals are found. According to Boulenger it is present in almost every horse in the Punjab. v. Linstow records it from the horse at Colombo, Ceylon, while Gaiger states that it is very common in the horse in India, and also records it from Burma. It is, however, possible that some of Gaiger's records refer to other species, since he mentions that it is "common in the circulatory apparatus," which points rather to the larvæ of *S. vulgaris*.

The male measures 26–35 mm. in length and 1.1–1.3 mm. in maximum thickness, the female 38–47 mm. and 1.8–2.25 mm. respectively. The head is not marked off from the body. The buccal capsule is oval and measures about 1.1 mm. in length and 0.8–0.9 mm. in maximum width. The external leaf-crown consists of numerous simple, leaf-like elements. The elements of the internal leaf-crown are small and hair-like. The two conical dorsal teeth arise by the bifurcation of a single

outgrowth from the dorsal gutter near its base. The two subventral teeth are also conical, but smaller and situated further back. The œsophagus measures 1.7–1.8 mm. in length in the male and 2.3–2.5 mm. in the female. The excretory pore is situated close behind the mouth-collar.

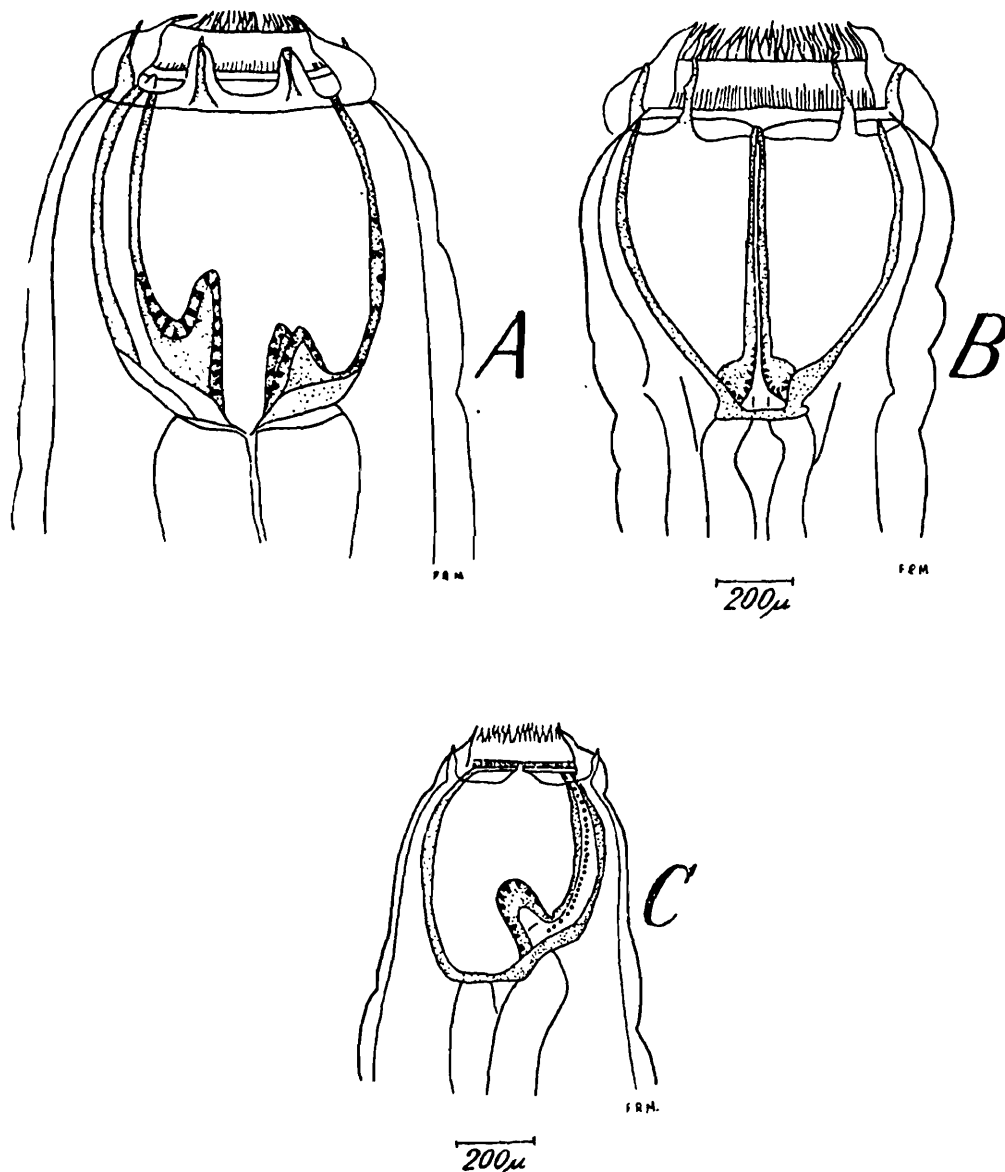

Fig. 116.—Anterior ends of three species of *Strongylus*. A, *S. equinus*, lateral view; B, *S. edentatus*, dorsal view; C, *S. vulgaris*, lateral view. (From Baylis, after Theiler.)

The dorsal ray of the bursa is about 0.5–0.6 mm. long. Its branches originate rather close together and are of sub-equal length.

The tail of the female is bluntly tapering and 0.5–0.6 mm. long. The vulva is situated at 12–14 mm. from the posterior extremity.

Subgenus **ALFORTIA** Railliet, 1923.

Buccal capsule without teeth. Genital cone well developed. An accessory piece present. Adults parasitic in Equidæ.

Type-species :—*S. (Alfortia) edentatus* (Looss, 1900).

2. **Strongylus (Alfortia) edentatus** (Looss, 1900) Railliet and Henry, 1909. (Figs. 116, B, & 117.)

Synonym :—*Sclerostoma edentatum* Looss, 1900.

Hosts :—This species may occur in any member of the horse tribe, and is of cosmopolitan distribution. Boulenger found it to be abundant in horses in the Punjab.

The male measures 23–28 mm. in length and 1.3–1.5 mm. in maximum thickness, the female 33–44 mm. and 1.6–2.2 mm.

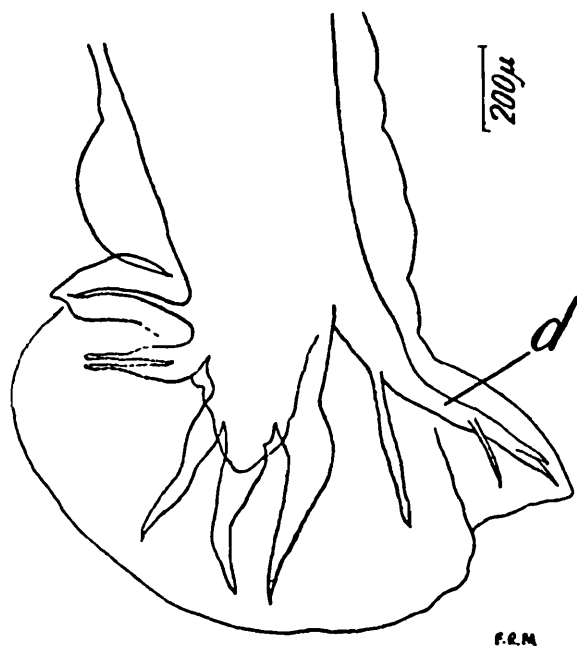

Fig. 117.—*Strongylus edentatus*. Bursa of male; lateral view. *d.*, dorsal ray. (From Baylis, after Theiler.)

respectively. The head is marked off from the body by a constriction, which is especially noticeable in the female. The buccal capsule is cup-shaped, narrowing considerably towards the base. It measures 0.8–1.1 mm. in length and 0.8–1.15 mm. in maximum width. The elements of the external leaf-crown are numerous, simple and pointed, those of the internal leaf-crown short and conical. The œsophagus measures about 1.8 mm. in length in the male, 2 mm. in the female. The excretory pore is situated close behind the mouth-collar.

The dorsal ray of the bursa is 0.4–0.475 mm. long and has slender branches, of which the outermost is the longest.

The tail of the female is 0.45–0.6 mm. long and bluntly tapering. The vulva is situated at 10–12 mm. from the posterior extremity.

Subgenus **DELAFONDIA** Railliet, 1923.

Buccal capsule with two dorsal teeth towards its base. Genital cone very feebly developed. An accessory piece present. Adults parasitic in Equidæ.

Type-species :—*S. (Delafondia) vulgaris* (Looss, 1900).

3. **Strongylus (Delafondia) vulgaris** (Looss, 1900) Railliet and Henry, 1909. (Fig. 116, C.)

Synonym :—*Sclerostoma vulgare* Looss, 1900.

Hosts :—This species may occur in any member of the horse tribe, and is of cosmopolitan distribution. Boulenger found it to be common in horses in the Punjab.

The male measures 14–16 mm. in length and 0.75–0.95 mm. in maximum thickness, the female 20–24 mm. and 1–1.4 mm. respectively. The head is not marked off from the body. The buccal capsule is cup-shaped, but somewhat asymmetrical when seen in lateral view, its wall being more convex on the dorsal than on the ventral side. It measures up to about 0.6 mm. in length and slightly less in maximum width. Two large, rounded teeth arise by the bifurcation of a single process at the base of the dorsal gutter. The elements of the external leaf-crown are fringed. Those of the internal leaf-crown are apparently represented by a circle of irregularly-shaped bodies within the mouth-collar. The œsophagus is 1.3–1.4 mm. long in the male, 1.5–1.7 mm. in the female. The excretory pore and cervical papillæ are situated at about the level of the nerve-ring (1.45 mm. from the anterior extremity).

The dorsal ray of the bursa is 0.55–0.6 mm. long, and has rather stout main branches.

The tail of the female measures 1–1.2 mm. in length, and is slender and pointed. The vulva is situated at about 6–8 mm. from the posterior end.

Subgenus **DECRUSIA** Lane, 1914.

Mouth subterminal, facing slightly dorsally. Buccal capsule with two subventral teeth at its base. Accessory piece absent. Adults parasitic in elephants.

Type-species :—*S. (Decrusia) additicius* Railliet, Henry and Bauche, 1914.

4. *Strongylus (Decrusia) additicius* Railliet, Henry and Bauche, 1914.

Synonyms :—*Strongylus additictus* * Railliet, Henry and Bauche, 1914; *Decrusia decrusi* Lane, 1914; *Decrusia additicia* Railliet, Henry and Bauche, 1915; *Decrusia additictia* Khalil, 1922.

Host :—Indian elephant (large intestine). This species, originally recorded by Railliet, Henry and Bauche from Indo-China, was also obtained by Lane in Travancore.

The male measures 14–20 mm. in length and 1–1.4 mm. in maximum thickness, the female 15–24 mm. and 1.4–1.6 mm. respectively. The cuticular striations are at intervals of 10–13 μ . The head is not distinct from the body. The buccal capsule is oval and measures about 0.5 mm. in length and 0.45 mm. in maximum width. The dorsal gutter is well developed, but without teeth. There are two triangular subventral teeth near the base of the capsule. The external leaf-crown consists of 140 to 150 slender elements. The oesophagus measures 1.75–1.9 mm. in length. The excretory pore is situated at 1 mm., and the nerve-ring at 1.1 mm., from the anterior end.

The dorsal lobe of the bursa is produced into a sharp point. The dorsal ray is undivided until near its tip. Its terminal branches are rather variable in number and disposition. There may be two or three on each side. The spicules are 2.3–2.45 mm. long, and taper to fine points.

The tail of the female is about 0.3 mm. long, and is bluntly conical, but sometimes has a short terminal spike. There is a pair of caudal papillæ at 0.05 mm. from the tip. The vulva is situated at 7.3 mm. from the posterior extremity, and the body is abruptly narrowed behind it. The vagina runs forward from the vulva. It "is folded and enters a bilobed muscular ovejector apparatus, from which the two diverging uteri spring, the caudad of these having a very short caudad course before turning sharply cephalad" (*Lane*). The eggs are oval, with thin shells, measuring 0.065–0.075 \times 0.04–0.045 mm. Their contents are segmenting at the time of laying.

Life-history of the species of Strongylus.—The life-history of these worms is not yet known in complete detail, but in broad outline it appears to be somewhat as follows. The eggs passed to the exterior with the droppings of the host hatch within about two days, and during the next four to seven

* *additictus* was the original spelling, but is assumed to have been a misprint, as *additicius* occurs later in the same paper.

days the larvæ undergo two moults. The cuticle of the second moult is retained, and the larvæ are now at the infective stage. They are capable of climbing up on to herbage, and are very resistant to drying and to changes of temperature. If ingested by a suitable animal, they moult again and penetrate into the wall of the large intestine, where some of them may become temporarily encysted under the mucous membrane. The majority, however, apparently enter the blood-vessels and are carried by the blood-stream to different parts of the body. Fourth-stage larvæ of *Strongylus equinus* are found mainly in the liver, pancreas and perirenal tissue, and those of *S. edentatus* under the parietal peritoneum. The larvæ of *S. vulgaris*, according to Olt (1932), normally migrate by way of the portal system and right heart to the lungs and trachea, are swallowed again and become adult in the colon. Frequently, however, the larvæ of this species become lodged in the mesenteric arteries, where they cause thrombi and aneurisms, and may grow to a length of 20 mm.

It has been suggested that the larvæ of all the species ultimately leave the various organs in which they are lodged, and return to the intestine by boring through its wall from outside. Though this may sometimes occur, it seems not unlikely that the normal course of migration is similar in all cases to that described by Olt for *S. vulgaris*, and that larvæ found in such organs as the liver and pancreas have "lost their way," and are mostly destined never to become adults.

2. Genus **TRIODONTOPHORUS** Looss, 1902.

Synonym :—*Triodontus* Looss, 1900, *nec* Westwood, 1845.

External and internal leaf-crowns present, their elements of equal number. Buccal capsule almost globular, rather small, but with relatively thick walls. Dorsal gutter present. From the œsophageal funnel three pairs of teeth project into the buccal capsule. Spicules terminate in small hooks. Vulva relatively close to the posterior end of the body. Uterine branches parallel. Adults parasitic in the large intestine of Equidæ.

Genotype :—*Triodontophorus minor* (Looss, 1900).

Key to Species.

- | | |
|---|-----------------------------|
| Tail of female more than 0·4 mm. long ; mouth-collars circular in optical section or somewhat flattened | <i>serratus</i> , p. 254. |
| Tail of female less than 0·2 mm. long | 1. |
| 1. Mouth-collars flattened, widest posteriorly | <i>minor</i> , p. 254. |
| Mouth-collars high, widest anteriorly | <i>brevicauda</i> , p. 255. |

1. *Triodontophorus minor* (Looss, 1900) Looss, 1902.

Synonym :—*Triodontus minor* Looss, 1900.

Host :—This species was found commonly in horses in the Punjab by Boulenger.

The male measures 9–13 mm. in length and 0.7–0.8 mm. in maximum thickness, the female 11–16 mm. and 0.75–0.85 mm. respectively. The mouth-collar is flattened, especially at its posterior margin, which sometimes tends to curl forward. The buccal capsule measures 0.12–0.19 mm. in length and 0.14–0.19 mm. in width. Each of the teeth has three prominent anterior projections, the margins of which may be smooth or deeply serrated. Each leaf-crown contains about 44 to 50 elements. The œsophagus is 0.92–1.15 mm. long. The excretory pore and cervical papillæ are situated a little behind the nerve-ring, at 0.6–0.8 mm. from the anterior extremity.

The dorsal lobe of the bursa is rather long. The spicules measure about 1.7 mm. in length, and have a short spur at the point where the tips bend forward. The tail of the female is 0.13–0.17 mm. long. The vulva is situated at 0.44–0.7 mm. from the anus. The eggs measure 0.076–0.09 × 0.04–0.05 mm.

2. *Triodontophorus serratus* (Looss, 1900) Looss, 1902.
(Fig. 118.)

Synonyms :—*Triodontus serratus* Looss, 1900 ; *Triodontophorus intermedius* Sweet, 1909.

Host :—This species was found by Boulenger on several occasions in horses at Lahore and Sargodha, Punjab. It is also recorded by v. Linstow from ponies on Iranativu, Ceylon.

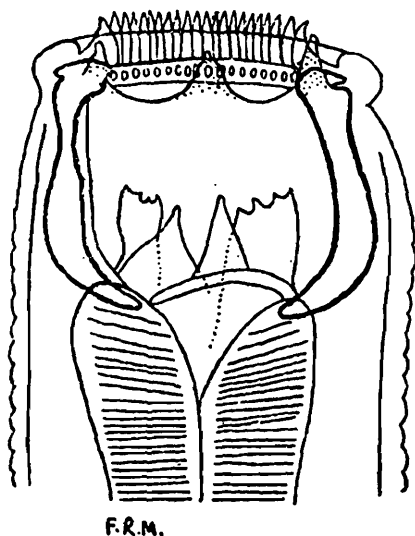

Fig. 118.—*Triodontophorus serratus*. Anterior end ; lateral view.
(From Baylis, after Yorke and Maplestone.)

The male measures 14·5–20 mm. in length and 0·65–0·8 mm. in maximum thickness, the female 16·5–26 mm. and 0·65–1·1 mm. respectively. The mouth-collar is variable in shape, and may be circular in optical section or somewhat flattened. The buccal capsule measures 0·1–0·13 mm. in length and 0·14–0·18 mm. in width. The edges of the teeth, which extend to about the middle of the capsule, are usually denticulate. Each leaf-crown contains 48 to 55 elements, those of the internal crown being small and plate-like. The œsophagus is 0·97–1·6 mm. long. The excretory pore and cervical papillæ are situated just behind the nerve-ring, at 0·54–0·95 mm. from the anterior extremity.

The dorsal lobe of the bursa is short and broad. The spicules are stout, and have their tips curved into a hook, with a barb on the opposite side of the shaft a little before the tip. The tail of the female is 0·45–0·8 mm. long. The vulva is situated at 1·45–2·7 mm. from the posterior end. The eggs measure 0·076–0·1 × 0·04–0·05 mm.

3. *Triodontophorus brevicauda* Boulenger, 1916. (Fig. 119.)

Host :—This species was found once by Boulenger among material from a horse at the Punjab Veterinary College, Lahore. It was first recorded in England.

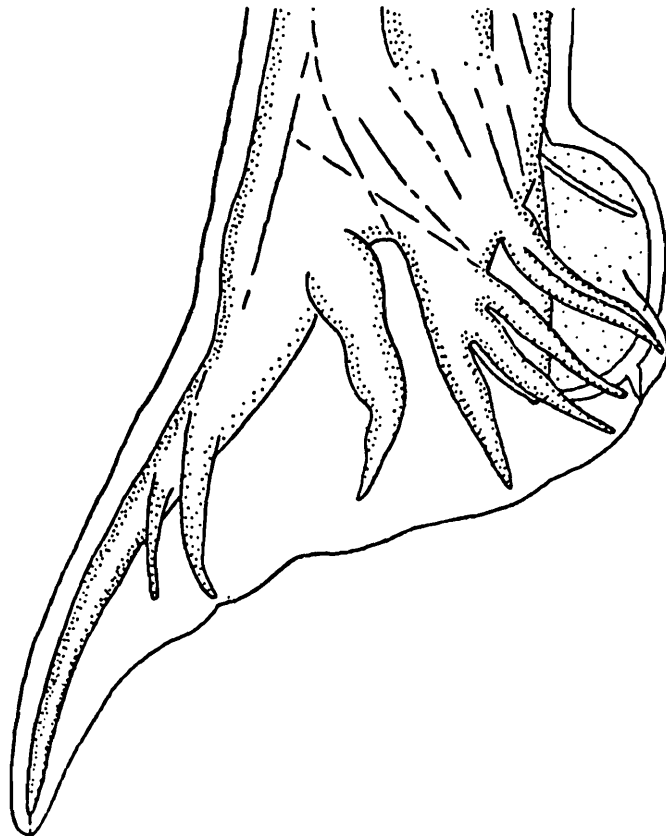

Fig. 119.—*Triodontophorus brevicauda*. Bursa of male; lateral view. (After Boulenger, in 'Parasitology.')

The male measures 13·5–15 mm. in length and 0·6–0·75 mm. in maximum thickness, the female 13·5–17 mm. and 0·67–0·9 mm. respectively. The mouth-collar is high and erect, almost funnel-shaped, and widest at its anterior margin. The buccal capsule measures 0·15–0·21 mm. in length and 0·18–0·25 mm. in width. The edges of the teeth, which barely reach the middle of the capsule, are notched but usually not denticulate. Each leaf-crown contains an average of 60 elements. The œsophagus is 0·9–1·4 mm. long. The excretory pore and cervical papillæ are situated at about the level of the nerve-ring, at 0·73–0·9 mm. from the anterior extremity.

The dorsal lobe of the bursa is long. The spicules are slender, with their tips strongly recurved and having hammer-shaped barbs at their junction with the shafts. The tail of the female is 0·1–0·15 mm. long. The vulva is situated very close to the anus, at about 0·3 mm. from the posterior end. The body tapers rapidly behind the vulva so as to appear obliquely truncate. The eggs measure 0·076–0·1 × 0·04 mm.

3. Genus **ÆSOPHAGODONTUS** Railliet and Henry, 1902.

Synonym:—*Pseudosclerostomum* Quiel, 1919.

External and internal leaf-crowns present. Mouth-collar depressed. Buccal capsule goblet-shaped, with a circular ridge posteriorly. The lining of the œsophageal funnel is thrown into three small folds or teeth which do not project into the buccal capsule. Dorsal gutter absent. Bursa entire. Dorsal ray cleft to the point of origin of its accessory branches, of which there are three pairs. Postero-lateral ray with an accessory branch. Vulva relatively distant from anus. Uterine branches parallel. Adults parasitic in Equidæ.

Genotype:—*Æsophagodontus robustus* (Giles, 1892).

1. **Æsophagodontus robustus** (Giles, 1892) Railliet and Henry, 1902. (Figs. 120 & 121.)

Synonyms:—*Sclerostoma robustum* Giles, 1892; *Pseudosclerostomum securiferum* Quiel, 1919.

Hosts:—This species occurs in the colon and cæcum of horses, mules and zebras in various parts of the world, but does not appear to be a very common parasite. It was first recorded by Giles from a mule in India, and has also been found in horses in the Punjab and elsewhere (Montgomery, Boulenger).

The male measures 15–16 mm. in length and 0·95–1 mm. in maximum thickness, the female 19–22 mm. and 1·1–1·5 mm.

Fig. 120.

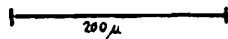
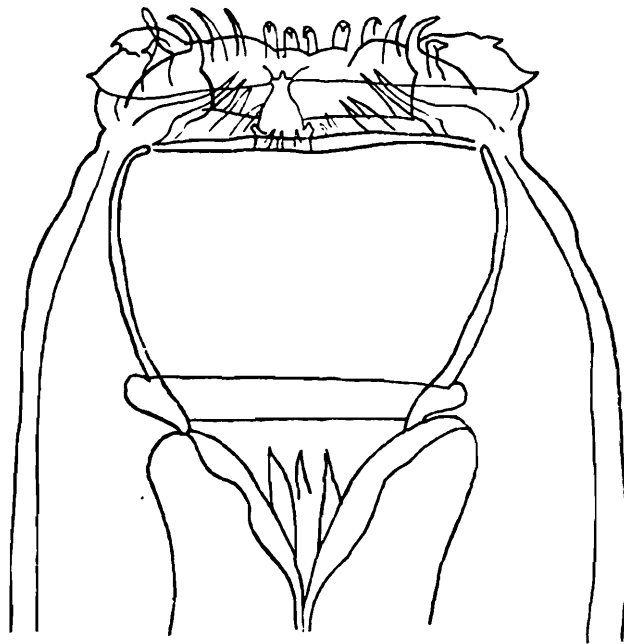

Fig. 121.

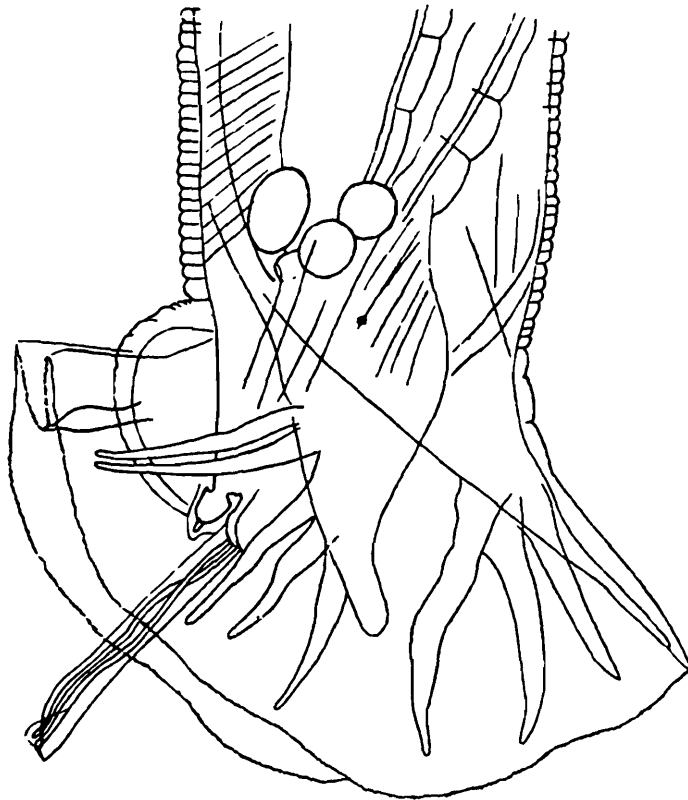

Fig. 120.—*Æsophagodontus robustus*. Anterior end. (After Theiler.)

Fig. 121.—*Æsophagodontus robustus*. Bursa of male; lateral view.
(After Boulenger, in 'Parasitology'.)

respectively. The head is marked off from the body by a slight constriction, and measures 0.5–0.8 mm. in width. The buccal capsule has its wall greatly thickened externally at the posterior end by an annular ridge. The capsule measures 0.22–0.32 mm. in length. Its maximum width, near the anterior end, is 0.32–0.47 mm., and it is considerably narrowed behind. The external leaf-crown consists of about 18 large elements, and the internal leaf-crown of about 36 considerably smaller elements. The œsophagus measures 1.3–1.7 mm. in length. Its greatest width (up to 0.31 mm.) occurs just behind the buccal capsule. It then narrows towards the middle and widens again posteriorly. The excretory pore and the very small cervical papillæ are situated slightly behind the nerve-ring, at 1.2–1.3 mm. from the anterior extremity.

The genital cone of the male is short and broad, almost hemispherical in shape, and bears a pair of lateral papillæ. The spicules are long and slender, with blunt tips, and are enclosed in a finely-striated sheath.

The tail of the female measures 0.43–0.7 mm. in length and is variable in shape, often appearing mucronate. The vulva is situated at 2.75–3.7 mm. from the posterior end. The eggs are oval and thin-shelled, and measure 0.088–0.13 × 0.04–0.06 mm. Their contents are in an early morula stage at the time of laying.

4. Genus **EQUINURBIA** Lane, 1914.

Body fairly stout. External leaf-crown composed of numerous elements of two lengths, two short elements being placed between each pair of long elements. Buccal capsule subglobular, with a long dorsal gutter. Externo-dorsal rays of bursa with two accessory branches and a dorsal boss. Dorsal ray cleft for about half its length. The externo-dorsal rays and two pairs of accessory branches of the dorsal ray spring from the median stem of that ray. Vulva prominent, close to the anus. Uterine branches parallel. Adults parasitic in elephants.

Genotype :—*Equinurbia sipunculiformis* (Baird, 1859).

1. **Equinurbia sipunculiformis** (Baird, 1859) Lane, 1914.

Synonyms :—*Sclerostoma sipunculiforme* Baird, 1859; *Sclerostoma spinuliferum* Cobbold, 1879; *Cylicostomum sipunculiforme* Railliet, Henry and Bauche, 1914.

Host :—Indian elephant (cæcum).

The male measures, on an average, 15 mm. in length and 1.3 mm. in maximum thickness, the female 27.5 mm. and 1.5 mm. respectively. The head is marked off from the body by a distinct “neck.” The buccal capsule is cup-shaped.

The dorsal wall of the capsule is slightly shorter than the ventral, and the mouth is tilted slightly dorsally. The external leaf-crown contains, according to Lane, 168 rays, of which 56 are long and 112 short. The internal leaf-crown consists of 112 short elements. The œsophagus is 2.3 mm. long. It is somewhat enlarged immediately behind the buccal capsule, then becomes cylindrical, and gradually enlarges again behind the nerve-ring, which is situated at 0.6 mm. from the anterior end. The excretory pore and cervical papillæ are situated slightly behind the junction of the œsophagus and intestine.

The spicules measure 1.5 mm. in length. The tail of the female is 0.8 mm. long, and bears a pair of caudal papillæ at 0.35 mm. from the tip. Lane describes the posterior end of the female as follows:—"The anus lies at the bottom of a depression between the tail and a marked caudad-projecting conical prominence, on the summit of which the vulva opens. Baird and Cobbold have likened the whole effect, when the tail is viewed from the side, to that of a Chinese woman's foot. The vagina runs cephalad for 1.7 mm. and then divides into the two uteri which run cephalad side by side, and are furnished with weak ojectors, the bulbs of which lie 1.5 mm. from the bifurcation. The ovarian coils reach to a point 6 mm. caudad of the junction of the œsophagus and chyle-intestine." The eggs are thin-shelled and measure $0.06 \times 0.03-0.035$ mm. Their contents are segmenting at the time of laying.

5. Genus **CHONIANGIUM** Railliet, Henry and Bauche, 1914.

Synonym:—*Asifta* Lane, 1914.

Anterior extremity obliquely truncate, so that the mouth-opening faces somewhat dorsally. External leaf-crown composed of numerous long, fine elements. Internal leaf-crown absent. Buccal capsule elongate, narrowing posteriorly. No teeth in the buccal capsule, but paired hemispherical bosses present on the internal surface of its wall. Dorsal gutter apparently absent. Postero-lateral ray of bursa with a well-developed accessory branch. Externo-dorsal rays and a pair of accessory branches of the dorsal ray both spring from the median dorsal stem, the accessory branches being cleft almost to their bases. Main stem of dorsal ray cleft for less than half its length. An accessory piece present. Tail of female short and straight. Vulva close to anus. Uterine branches parallel. Adults parasitic in elephants.

Genotype:—*Choniangium epistomum* (Piana, in Piana and Stazzi, 1900).

1. **Choniangium epistomum** (Piana, in Piana and Stazzi, 1900)
Railliet, Henry and Bauche, 1914. (Fig. 122.)

Synonyms:—*Sclerostoma epistomum* Piana, in Piana and Stazzi, 1900; *Asifia vasifa* Lane, 1914.

Host:—Indian elephant (cæcum). Lane's material was obtained at Murshidabad, Bengal.

The male measures 14 mm. in length, the female 19 mm. The greatest thickness occurs near the head, and is 0.75 mm. in the male and 1 mm. in the female. The body of the male narrows to 0.4 mm. posteriorly. The cuticular striations are at intervals of $4\ \mu$. The buccal capsule is about 0.75 mm.

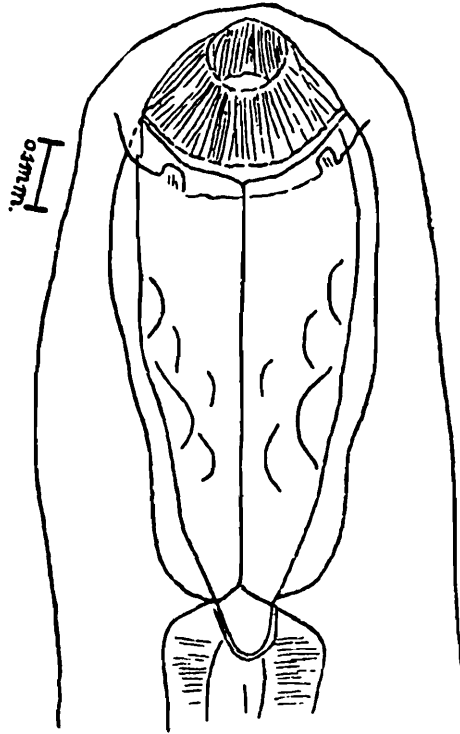

Fig. 122.—*Choniangium epistomum*. Anterior end; dorsal view.
(After Lane.)

long and has a maximum diameter, near the anterior end, of about 0.35 mm. There are, according to Lane, "five pairs of hemispheroidal cuticular prominences projecting into the oral cavity. One pair of these lies caudad of its equator close to the mid-dorsal duct. Cephalad of these and on a more ventral plane lies a second pair. Ventrad of the first pair, at about the level of the lateral lines, lies a third pair, while a fourth pair lies ventrad of the second pair, and nearer the mid-ventral line than the third. The fifth pair is close to the ventral midline about the equator of the cavity." The external leaf-crown contains 53 converging rays. The œsophagus is 1.5 mm. long, and gradually increases in diameter posteriorly to a maximum of 0.32 mm. The nerve-ring is

situated at 1.25 mm., the cervical papillæ at 2 mm., and the excretory pore at 2.2 mm., from the anterior extremity.

“The spicules measure 2 mm. long. They are widest about their equator. The peripheral part has a double S curve gradually tapering to a very fine point. When seen from the side the accessory piece is deeper caudad than cephalad, but when seen from the dorsum the appearance is the reverse, and at the same time the cephalad edge is deeply notched” (*Lane*).

The tail of the female is 0.5 mm. long, and bears a pair of papillæ at 0.15 mm. from the tip. The vulva is situated at 0.8 mm. from the posterior end. “The vagina runs cephalad, slightly sinuous, for 1 mm. and then divides into the two parallel cephalad-running uteri. The bulbs of the ovejectors are situated 0.6 mm. from the vagina. The uteri end 8 mm. further cephalad, and the ovarian coils extend to 1 mm. caudad of the beginning of the chyle-intestine. The ova measure 0.05×0.025 mm.” (*Lane*).

2. *Choniangium* sp.

Ware (1924) has recorded immature specimens of a species of *Choniangium* from nodules in the wall of the large intestine of an elephant at Coorg, South India. It seems possible that these may have been *C. epistomum*, although the transverse striations of the cuticle were coarse (about 18μ apart) and very prominent.

6. Genus **DELETROCEPHALUS** Diesing, 1851*.

Synonym:—*Quasistrongylus* Maplestone, 1932.

Head somewhat compressed laterally. Mouth elliptical and directed anteriorly. Buccal capsule large and subglobular, with an undulating anterior border, an external leaf-crown consisting of six very broad, longitudinally-striated elements, and an internal leaf-crown of numerous small elements. At the base of the capsule a number of anteriorly-directed teeth, including a dorsal pair which are longer than the rest. A small œsophageal funnel present, with longitudinal ridges in its walls. Œsophagus club-shaped, with stout cuticular lining. Bursa

* The systematic position of this genus is somewhat uncertain. It was placed by Baylis and Daubney (1926) in the subfamily Trichoneminæ, but in view of the fuller descriptions now available it should perhaps be transferred to the Strongylinæ. Railliet and Henry, in 1911, placed it, together with *Codiostomum* (a parasite of the ostrich), in a special tribe, Deletrocephalæ, of the Strongylinæ. *Codiostomum*, however, is a typical member of the Strongylinæ, and *Deletrocephalus* does not appear to be more closely allied to it than to other genera of the subfamily.

of male excised anteriorly. Prebursal papillæ absent. Ventral rays short, close together and widely divergent from the lateral rays. The lateral rays originate from a common trunk, the postero-lateral being the longest. The externo-dorsal rays originate from the stem of the dorsal ray. The latter is bifurcate distally and gives off one or two pairs of accessory branches before its bifurcation. The terminal branches are simple. Spicules slender. An imperfectly-chitinized accessory piece present. Vulva situated on a large prominence close to the anus. Uterine branches parallel. Adult worms parasitic in a bird (*Rhea*).

Genotype :—*Deletrocephalus dimidiatus* Diesing, 1851.

1. *Deletrocephalus dimidiatus* Diesing, 1851.

Synonyms :—*Strongylus dimidiatus* Schneider, 1866; *Quasi-strongylus rheæ* Maplestone, 1932.

Host :—South American ostrich, or rhea (*Rhea americana*) (intestine); Zoological Gardens, Calcutta (Maplestone).

There appears to be little doubt that, as Lins de Almeida* has pointed out and Maplestone† has himself recognized, the specimens recorded by Maplestone (1932, *b*) under the name of *Quasistrongylus rheæ* belonged to Diesing's species, of which a new description, based on South American material, has been given by Travassos (1933).

This species appears to be very variable in size. Molin (1861), indeed, recognized two varieties, *major* and *minor*, the former measuring 16–26 mm., the latter 8–9 mm. in length. Schneider's specimens also seem to have been very large, as he gives the length of the male as 18 mm. and that of the female as 22 mm. According to Maplestone and Travassos the male measures about 8.5–12 mm. in length and the female about 13–15 mm., and the maximum thickness of both sexes appears to vary between about 0.35 mm. and 0.5 mm. The length of the buccal capsule is given by Travassos as 0.072–0.104 mm., and by Maplestone as 0.125–0.13 mm. The former author gives its diameter as 0.096–0.136 mm., the latter as 0.14–0.144 mm., but it is not stated whether the latero-lateral or the dorso-ventral diameter is referred to. According to Travassos the number of teeth at the base of the capsule is 13, there being six pairs and an unpaired ventral tooth. Maplestone states that, while the long dorsal teeth have simple points, the shorter teeth end in bifid points. Although neither author mentions a dorsal gutter, both figure a structure

* Compt. rend. Soc. Biol., Paris, cxviii, p. 285 (1935).

† Rec. Ind. Mus. xxxvii, p. 335 (1935).

which probably represents this organ, and which evidently extends nearly as far as the margin of the capsule. The œsophagus is 0.64–0.85 mm. long. The nerve-ring is situated at about 0.25–0.36 mm. from the anterior end. Travassos states that the excretory pore and cervical papillæ are also at about this level, but Maplestone gives their distance from the anterior end as 0.535 mm. in the male and 0.693 mm. in the female.

The spicules of the male, according to Maplestone, are equal, have recurved tips and measure 1 mm. in length. According to Travassos they are slightly unequal, and measure respectively 0.94–0.97 mm. and 0.97–1 mm. Schneider gave their length as “at least 5 mm.” The accessory piece, according to Maplestone, measures 0.06 mm. in length and is “in the form of a chitinized tube.” According to Travassos it is imperfectly chitinized and shows radiating chitinous thickenings in its middle portion, and two longitudinal prolongations. Judging from his figure, these prolongations are at its anterior end. There is a genital cone bearing, according to Maplestone, a pair of broad, mammilliform papillæ.

The tail of the female is tapering and pointed, and measures about 0.21–0.22 mm. (Travassos) or 0.27–0.36 mm. (Maplestone) in length. The vulva either opens upon, or is overhung by, a large prominence a short distance from the anus. According to Travassos the distance from the vulva to the posterior extremity is 0.38–0.43 mm. Maplestone, however, gives the distance from vulva to anus as 0.4 mm., so that the distance from the vulva to the posterior end would be about 0.7 mm. The short, muscular vagina divides to form a pair of muscular ojectors which run forward parallel to each other. The length of the whole muscular apparatus, according to Travassos, is 0.88–1 mm., but according to Maplestone apparently about 2 mm. The terminology employed by the two authors for the various parts is, however, different, and this renders comparison of the descriptions somewhat difficult. The eggs measure about 0.16–0.17 × 0.07–0.08 mm.

Subfamily TRICHONEMINÆ Railliet, 1916.

Buccal capsule cylindrical, with relatively thick walls. Dorsal gutter comparatively short, not reaching the anterior margin of the capsule. No ventral cervical groove or cephalic vesicle. Parasites of the alimentary tract of vertebrates.

Key to Genera.

- | | |
|---|---------------------|
| Wall of buccal capsule widely separated from lining of mouth-cavity. | QUILONIA, p. 284. |
| Wall of buccal capsule not widely separated from lining of mouth-cavity. | 1. |
| 1. Wall of buccal capsule divided into an anterior ring-shaped and a posterior cup-shaped portion | [p. 288.] |
| Wall of buccal capsule not so divided. | BOURGELATIA, |
| 2. Elements of external leaf-crown longer laterally than dorsally or ventrally | 2. |
| Elements of external leaf-crown of uniform length | MURSHIDIA, p. 278. |
| 3. Œsophagus hourglass-shaped | 3. |
| Œsophagus not hourglass-shaped | KHALILIA, p. 282. |
| 4. External leaf-crown consists of six elements. | 4. |
| External leaf-crown consists of more than six elements | KILULUMA, p. 286. |
| 5. Dorsal ray of bursa of male bifurcate almost to its base | 5. |
| Dorsal ray of bursa bifurcate for only about half its length | TRICHONEMA, p. 264. |
| | [p. 276.] |
| | POTERIOSTOMUM, |

1. Genus **TRICHONEMA** Cobbold, 1874.

Synonyms :—*Cyathostomum* Molin, 1861, and Looss, 1900 (nec *Cyathostoma* Blanchard, 1849); *Cylicostomum* Railliet, 1901; *Cylichnostomum* Looss, 1902.

External and internal leaf-crowns present. Buccal capsule rather shallow, more or less cylindrical, without teeth. Œsophageal funnel generally well developed. Dorsal ray of bursa bifurcate almost to the point of origin of the externo-dorsal rays. The two pairs of accessory branches of the dorsal ray spring from the bifurcate portion and not from the median stem. Spicules terminating in double hooks. Vulva close to anus. Uterine branches parallel. Adults parasitic in Equidæ.

Genotype :—*Trichonema longibursatum* (Yorke and Macfie, 1918).

Over thirty species of this genus have been described as occurring in the cæcum and colon of members of the horse tribe. Most of them occur indifferently in horses, donkeys, mules and zebras, and are of cosmopolitan distribution.

The genus has been split up into eight subgenera, which some authors would treat as genera. The four subgenera to be dealt with here may be separated by means of the following key :—

- | | | |
|---|----|---------------------------|
| Elements of internal leaf-crown rod-like, originating near anterior margin of buccal capsule | 1. | |
| Elements of internal leaf-crown triangular plates, originating some distance behind anterior margin of buccal capsule | 2. | |
| 1. Wall of buccal capsule with a hoop-like thickening posteriorly | | [p. 271.
CYLICOCYCLUS, |
| Wall of buccal capsule without a posterior thickening | | [p. 265.
TRICHONEMA, |
| 2. Posterior end of female straight or slightly bent dorsally | | [p. 268.
CYLICOSTOMUM, |
| Posterior end of female strongly bent dorsally and shaped somewhat like a human foot in lateral view | | [p. 272.
CYLICOCERCUS, |

Subgenus **TRICHONEMA** Le Roux, 1924.

Synonym :—*Cylicostephanus* Ihle, 1922.

Mouth-opening circular. Mouth-collar depressed. Buccal capsule usually long and cylindrical, or somewhat narrowed anteriorly. The elements of the internal leaf-crown are short rods, situated in the immediate neighbourhood of the anterior margin of the capsule. Tail of female usually straight.

Type-species :—*T. (Trichonema) longibursatum* (Yorke and Macfie, 1918).

Key to Species.

- | | |
|---|------------------------------------|
| Buccal capsule almost cylindrical. | 1. |
| Buccal capsule narrowed anteriorly | 2. |
| 1. External leaf-crown contains 8 to 10 elements. | <i>calicatum</i> , p. 267. |
| External leaf-crown contains 30 to 35 elements. | <i>poculatum</i> , p. 268. |
| 2. External leaf-crown contains 8 elements. | <i>minutum</i> , p. 267. |
| External leaf-crown contains 14 to 18 elements. | <i>longibursatum</i> ,
[p. 265. |

1. **Trichonema (Trichonema) longibursatum** (Yorke and Macfie, 1918). (Figs. 123 & 124.)

Synonyms :—*Cylicostomum longibursatum* Yorke and Macfie, 1918 ; *Cylicostomum calicatiforme* Kotlán, 1919 ; *Cylicostomum nanum* Ihle, 1919 ; *Cylicostomum (Cylicostephanus) longibursatum* Ihle, 1922.

Host :—This species is recorded by Boulenger from horses at Sargodha, Punjab.

The length of both sexes is about 5–7 mm., and the maximum thickness about 0.2 mm. The mouth-collar is low, but marked off from the body by a constriction. The lateral cephalic papillæ are prominent. The buccal capsule is wider behind

Fig. 123.

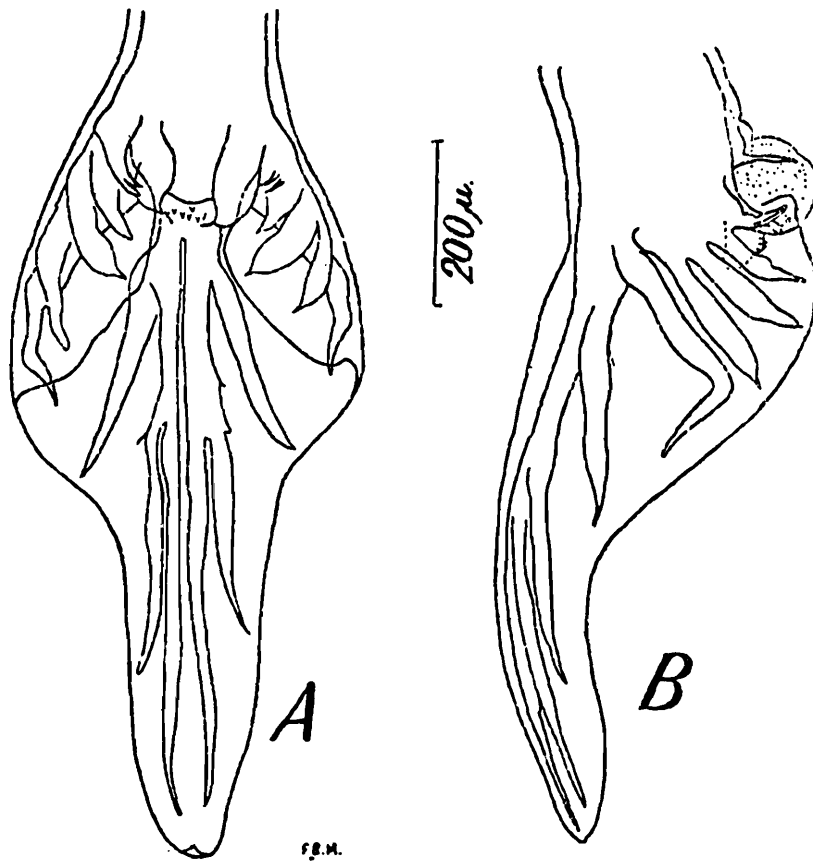

Fig. 124.

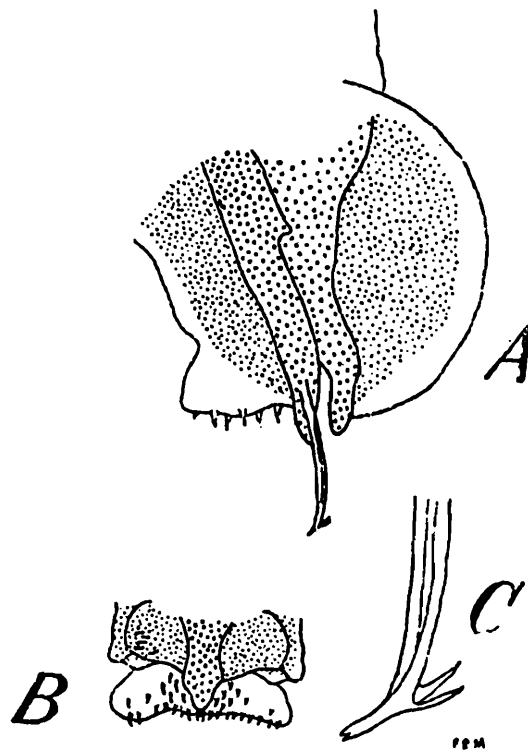

Fig. 123.—*Trichonema longibursatum*. Bursa of male. A, ventral view; B, lateral view. (From Baylis, after Theiler.)

Fig. 124.—*Trichonema longibursatum*. A, genital cone and appendages, lateral view; B, genital appendages, ventral view; C, tips of spicules. (From Baylis, after Yorke and Macfie.)

than in front. It measures 0.017–0.024 mm. in length and 0.026–0.032 mm. in greatest width. The external leaf-crown contains 14 to 18 elements. The œsophagus is 0.24–0.34 mm. long. The excretory pore and cervical papillæ are situated at 0.2–0.22 mm. from the anterior extremity.

The dorsal lobe of the bursa is very long and narrow. The tail of the female is 0.08–0.124 mm. long, and the vulva is situated at 0.051–0.073 mm. from the anus. The eggs measure 0.076–0.08 × 0.032–0.036 mm.

2. *Trichonema (Trichonema) calicatum* (Looss, 1900).

Synonyms:—*Cyathostomum calicatum* Looss, 1900; *Cylichostomum calicatum* Looss, 1902; *Cylicostomum calicatum* Geddoelst, 1903; *Cylicostomum (Cylicostephanus) calicatum* Ihle, 1922.

Host:—Recorded by Boulenger from horses at Sargodha, Punjab.

The male measures 5.5–6.5 mm. in length and 0.26–0.28 mm. in maximum thickness, the female 6.5–8 mm. and 0.28–0.34 mm. respectively. The mouth-collar is flattened, measures 0.075–0.088 mm. in width, and is marked off from the body by a slight constriction. The buccal capsule is almost cylindrical and measures 0.028–0.04 mm. in length and 0.024–0.038 mm. in width. Its walls are slightly thickened posteriorly. The external leaf-crown contains 8 to 10 broad elements. The œsophagus is 0.29–0.4 mm. long. The excretory pore and cervical papillæ are situated at about 0.22–0.25 mm. from the anterior extremity.

The bursa has a long, narrow dorsal lobe. The tail of the female is 0.06–0.1 mm. long, and the vulva is situated at 0.04–0.08 mm. from the anus. The eggs measure 0.064–0.068 × 0.036 mm.

3. *Trichonema (Trichonema) minutum* (Yorke and Macfie, 1918).

Synonyms:—*Cylicostomum minutum* Yorke and Macfie, 1918; *Cylicostomum calicatum* var. *minus* Kotlán, 1920; *Cylicostomum (Cylicostephanus) minutum* Ihle, 1922.

Host:—Recorded by Boulenger from horses in the Punjab.

Both sexes measure about 4–6 mm. in length and 0.23–0.28 mm. in maximum thickness. The mouth-collar is moderately high, measures about 0.06 mm. in diameter, and is not marked off from the body. The buccal capsule is widest posteriorly. It measures 0.02–0.028 mm. in length and 0.02 mm. in width. The external leaf-crown contains eight broad elements, the internal about 20 elements. The œsophagus is about 0.28–0.34 mm. long. The excretory pore and cervical papillæ are situated at 0.24–0.248 mm. from the anterior extremity.

The dorsal lobe of the bursa is short and broad. The tail of the female is 0.035–0.07 mm. long, and the vulva is situated at about 0.08–0.1 mm. from the anus.

4. *Trichonema* (*Trichonema*) *poculatum* (Looss, 1900).

Synonyms :—*Cyathostomum poculatum* Looss, 1900; *Cylichnostomum poculatum* Looss, 1902; *Cylicostomum poculatum* Gedoelst, 1903; *Cylicostomum* (*Cylicostephanus*) *poculatum* Ihle, 1922.

Host :—Found twice by Boulenger in material from horses at Sargodha, Punjab. Occurs in the cæcum, usually in small numbers.

The male measures 8–9 mm. in length and 0.36 mm. in maximum thickness, the female 10–11 mm. and 0.44 mm. respectively. The mouth-collar is flattened and continuous with the body, and has a diameter of 0.12–0.128 mm. The buccal capsule is nearly cylindrical and measures 0.06–0.082 mm. in length and 0.056–0.06 mm. in width. Its walls are thickened posteriorly. The external leaf-crown contains 30 to 35 elements. At about the middle of the capsule a ring of irregular processes project from the lining. The œsophagus is 0.77–1 mm. long. The excretory pore and cervical papillæ are situated at 0.46–0.56 mm. from the anterior extremity.

The dorsal lobe of the bursa is rather large and rounded. The genital cone is elongate, projecting beyond the edge of the bursa. The tail of the female is slender and measures 0.29–0.38 mm. in length. The vulva is situated at 0.15–0.16 mm. from the anus.

Subgenus **CYLICOSTOMUM** Ihle, 1922.

Synonym :—*Cylicostomias* Cram, 1925.

External leaf-crown consists of eighteen to twenty-four, mostly pointed, elements. Internal leaf-crown composed of thin, triangular, radially-disposed plates, whose origin extends backwards on to the internal surface of the buccal capsule some distance from its anterior margin. Buccal capsule rather short and thick-walled. Tail of female straight or slightly bent dorsally.

Type-species :—*T.* (*Cylicostomum*) *ægyptiacum* Railliet, 1923.

Key to Species.

- | | |
|---|-----------------------------|
| Buccal capsule more than 0.03 mm. long. | <i>coronatum</i> , p. 270. |
| Buccal capsule less than 0.02 mm. long . . . | 1. |
| 1. Mouth-collar not divided into "lips"; tail of female about 0.1 mm. long . . . | <i>ægyptiacum</i> , p. 269. |
| Mouth-collar divided into four "lips"; tail of female not more than 0.08 mm. long | <i>labiatum</i> , p. 270. |

5. *Trichonema* (*Cylicostomum*) *ægyptiacum* Railliet, 1923.
(Fig. 125.)

Synonyms :—*Strongylus tetracanthus* Mehlis, 1831 (part); *Sclerostoma quadridentatum* Dujardin, 1845 (part); *Sclerostomum tetracanthum* Diesing, 1851 (part); *Sclerostoma hexacanthum* Wedl, 1856 (part); *Cyathostomum tetracanthum* Molin, 1861 (part); *Cylichnostomum tetracanthum* Looss, 1902; *Cylicostomum tetracanthum* Geddoelst, 1903; *Cylicostomum* (*Cylicostomum*) *tetracanthum* Ihle, 1922.

Hosts :—In some countries, *e. g.*, Egypt, this is said to be the commonest species of *Trichonema* in the horse and donkey. It seems, however, somewhat doubtful whether it has yet been found in India. Gaiger (1915) records “*Cylichnostomum tetracanthum*” as being very common in horses in the Punjab. Boulenger (1921), however, did not find it there, even among the collection in the Punjab Veterinary College, and it seems probable that the name was used by Gaiger in a collective

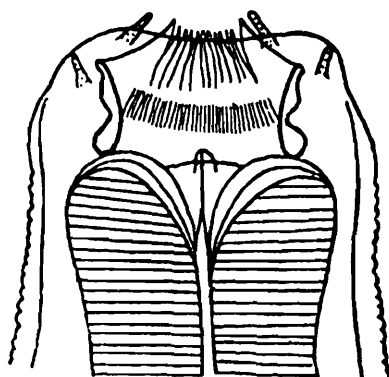

Fig. 125.—*Trichonema ægyptiacum*. Anterior end; dorsal view.
(After Yorke and Maplestone.)

sense for various species of *Trichonema*. Baylis and Daubney (1923, *b*) record “*Cylicostomum tetracanthum* (Mehl., 1831),” from a horse, as being represented in the collection of the Zoological Survey of India, but it is not certain that the specimens were of Indian origin. v. Linstow (1904) records “*Cylichnostomum tetracanthum*” from ponies on Iranativu, Ceylon, and quotes Looss, 1901. It is possible, therefore, that he may have been dealing with the species now known as *Trichonema ægyptiacum*, since this is the *C. tetracanthum* of Looss.

The male of *T. ægyptiacum* measures 7–9 mm. in length and about 0.3 mm. in maximum thickness, the female 8–12 mm. and 0.4–0.5 mm. respectively. The mouth-collar is somewhat flattened, and scarcely distinct from the body. The buccal capsule measures about 0.012 mm. in length and 0.06 mm. in width, its greatest width being at the anterior margin. Its walls are of irregular shape in optical section, with a somewhat

knee-shaped inward bend. The external leaf-crown contains about 22 elements, the internal leaf-crown about twice as many. These originate behind the middle of the capsule. The dorsal gutter is represented by a blunt knob on the posterior margin of the capsule. The œsophagus is 0.36–0.4 mm. long.

The dorsal lobe of the bursa is rounded and not distinctly marked off. The tail of the female is 0.1–0.12 mm. long, and the vulva is situated at 0.14–0.2 mm. from the anus. The eggs measure 0.076–0.08 × 0.036–0.04 mm.

6. *Trichonema (Cylicostomum) coronatum* (Looss, 1900).

Synonyms:—*Cyathostomum coronatum* Looss, 1900; *Cylichnostomum coronatum* Looss, 1902; *Cylicostomum coronatum* Gedoelst, 1903; *Cylicostomum (Cylichnostomum) coronatum* Ihle, 1922.

Host:—Boulenger found this species to be very common in horses in the Punjab.

The male measures 7–9 mm. in length and 0.34–0.36 mm. in maximum thickness, the female 9–10 mm. and 0.4–0.44 mm. respectively. The mouth-collar is rather low, and is marked off by a slight constriction. The buccal capsule is thick-walled and nearly cylindrical, but slightly narrowed in the middle. It measures 0.037–0.05 mm. in length and 0.024–0.028 mm. in width. The dorsal gutter does not project into the capsule. The external leaf-crown contains about 22 elements, the internal leaf-crown a large number. The œsophagus is 0.38–0.46 mm. long. The excretory pore and cervical papillæ are situated a little behind the nerve-ring, at about 0.28–0.3 mm. from the anterior extremity.

The dorsal lobe of the bursa is rather long and has nearly parallel sides. The tail of the female is 0.16–0.2 mm. long, and the vulva is situated at 0.12–0.14 mm. from the anus. The eggs measure 0.08–0.09 × 0.036–0.044 mm.

7 *Trichonema (Cylicostomum) labiatum* (Looss, 1902).

Synonyms:—*Cylichnostomum labiatum* Looss, 1902; *Cylicostomum labiatum* Gedoelst, 1903; *Cylicostomum (Cylichnostomum) labiatum* Ihle, 1922.

Host:—This species was obtained by Boulenger on several occasions, but usually in small numbers, from horses in the Punjab.

The male measures 7.7–9 mm. in length and 0.33–0.4 mm. in maximum thickness, the female 9.5–11 mm. and 0.36–0.42 mm. respectively. The mouth-collar is constricted off from the body and divided to form four large "lips," two of which are subdorsal and two subventral. The buccal capsule is very short (0.012–0.016 mm. in length) and measures 0.05–0.056 mm. in width. The dorsal gutter is represented

by a blunt tubercle. The external leaf-crown contains about 19 long and pointed elements. The œsophagus is 0.36–0.38 mm. long. The excretory pore and cervical papillæ are situated just behind the nerve-ring, at 0.3–0.38 mm. from the anterior extremity.

The dorsal lobe of the bursa is very short and rounded. The tail of the female is 0.045–0.08 mm. long and is slightly bent dorsally, but has a short point which is usually bent ventrally. The vulva is situated at 0.12–0.15 mm. from the anus. The eggs measure 0.076–0.08 × 0.032–0.038 mm.

Subgenus **CYLICOCYCLUS** Ihle, 1922.

Elements of internal leaf-crown usually small and numerous, generally in the form of fine rods, originating in the immediate neighbourhood of the anterior margin of the buccal capsule. The posterior margin of the wall of the buccal capsule forms a hoop-like thickening. Tail of female straight or only slightly bent dorsally, very seldom strongly bent.

Type-species :—*T. (Cylicocyclus) radiatum* (Looss, 1900).

Key to Species.

External leaf-crown contains 32 to 48 elements
External leaf-crown contains about 20 elements

insigne, p. 271.
nassatum, p. 272.

8. *Trichonema (Cylicocyclus) insigne* (Boulenger, 1917).

Synonyms :—*Cylichnostomum insigne* Boulenger, 1917; *Cylicostomum zebrae* Boulenger, 1920 (nec *Cylichnostomum zebrae* Turner, 1920); *Cylicostomum insigne* Boulenger, 1921; *Cylicostomum (Cylicocyclus) insigne* Ihle, 1922.

Host :—According to Boulenger this is the commonest species of *Trichonema* in the Punjab, being found in almost every horse, often in very large numbers. The adults are almost completely restricted to the hinder part of the colon, but larvæ are “found abundantly in the cæcum, usually encysted in the sub-mucosa, rarely free.”

The male measures 11–12.5 mm. in length and 0.62–0.7 mm. in maximum thickness, the female 13.5–15 mm. and 0.74–0.85 mm. respectively. The mouth-collar is rather high and is marked off from the body by a constriction. The lateral cephalic papillæ are large and prominent, projecting as horn-like processes. The buccal capsule is wide and rather shallow. It measures 0.046–0.066 mm. in length and 0.13–0.2 mm. in width. A dorsal gutter is absent. The external leaf-crown contains 32 to 48 pointed elements. The œsophagus is 0.7–1 mm. long, and the excretory pore and cervical papillæ are situated near its posterior end.

The dorsal lobe of the bursa is rather broad. The tail of the female is sometimes slightly bent dorsally, and measures 0.16–0.25 mm. in length. The vulva is situated at 0.14–0.2 mm. from the anus. The eggs measure 0.075–0.088 × 0.036–0.05 mm.

9. *Trichonema (Cylicocyclus) nassatum* (Looss, 1900).

Synonyms :—*Cyathostomum nassatum* Looss, 1900 ; *Cylichnostomum nassatum* Looss, 1902 ; *Cylicostomum nassatum* Gedoelst, 1903 ; *Cylicostomum (Cylicocyclus) nassatum* Ihle, 1922.

Host :—According to Boulenger this is, with the exception of *T. insigne*, the commonest species of *Trichonema* in horses in the Punjab. He found the variety *parvum* more abundantly than the typical form.

In the typical form the male measures 7–10 mm. in length and 0.3 mm. in maximum thickness, the female 9–14 mm. and 0.6–0.7 mm. respectively. The mouth-collar is contractile, and is marked off from the body by a deep constriction. Its transverse axis is longer than its dorso-ventral axis. The lateral cephalic papillæ are rather prominent. The buccal capsule is elliptical in section and is very short. It measures 0.036–0.04 mm. in length and 0.08 mm. in width. Its walls are very thin anteriorly. The dorsal gutter extends to about the middle of the capsule. The external leaf-crown contains about 20 elements. The internal leaf-crown is composed of minute rectangular plates. The œsophagus is 0.48–0.6 mm. long.

The dorsal lobe of the bursa is broad and rounded. The tail of the female is about 0.2 mm. long and is slightly bent dorsally. The vulva is situated at about 0.17 mm. from the anus.

9 a. Var. *parvum* Yorke and Macfie, 1918.

This variety is considered to differ from the typical form in size (average length, male 7 mm., female 8.8 mm.) and in having “ a third (small) lateral branch ” on the dorsal ray of the bursa. The latter character does not appear to be very distinctive, since Looss’s figure of the bursa of *T. nassatum* shows one such small branch on one side and two on the other. There is evidently considerable variation in this respect.

Subgenus **CYLICOCERCUS** Ihle, 1922.

External leaf-crown composed of twenty to twenty-nine elements. Elements of the internal leaf-crown like those of the subgenus *Cylicostomum*, but the region of their origin may extend back to a great distance from the anterior margin

of the buccal capsule. Posterior end of female strongly bent dorsally, with a pre-vulvar swelling, the whole somewhat resembling a human foot when viewed laterally.

Type-species :—*T. (Cylicocercus) alveatum* (Looss, 1900).

Key to Species.

- | | |
|--|----------------------------|
| Buccal capsule, in lateral view, narrower anteriorly than posteriorly | <i>goldi</i> , p. 274. |
| Buccal capsule, in lateral view, wider anteriorly than posteriorly | 1. |
| 1. Bases of elements of internal leaf-crown form a regularly curved line extending further forward laterally than dorsally and ventrally . | <i>catinatum</i> , p. 273. |
| Bases of elements of internal leaf-crown form a sinuous line | <i>pateratum</i> , p. 275. |

10. *Trichonema (Cylicocercus) catinatum* (Looss, 1900).
(Fig. 126.)

Synonyms :—*Cyathostomum catinatum* Looss, 1900 ; *Cylichnostomum catinatum* Looss, 1902 ; *Cylicostomum catinatum* Gedoelst, 1903 ; *Cylicostomum (Cylicocercus) catinatum* Ihle, 1922.

Host :—Boulenger found the typical form on several occasions in horses in the Punjab, usually in company with the variety *pseudo-catinatum*.

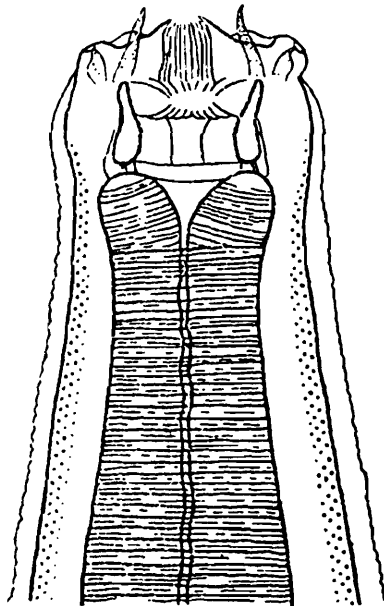

Fig. 126.—*Trichonema catinatum*, var. *pseudo-catinatum*. Anterior end ; ventral view. (After Yorke and Macfie.)

In the typical form the male measures 7–8 mm. in length and 0.35 mm. in maximum thickness, the female 9–9.5 mm. and 0.35 mm. respectively. The mouth-collar is distinctly marked off from the body. The dorso-ventral axis both of the collar and of the buccal capsule is slightly longer than the latero-lateral axis. The lateral cephalic papillæ are fairly prominent.

The buccal capsule is wider than long, and its walls are thicker laterally than dorsally and ventrally. A dorsal gutter is absent. The external leaf-crown contains 20 to 22 elements. The internal leaf-crown originates further forward at the sides than dorsally and ventrally.

The dorsal lobe of the bursa is rounded and not marked off from the lateral lobes. The posterior end of the female is bent dorsally at right angles to the body, and the tail is very short. The vulva is situated at 0.06 mm. from the anus.

10 *a.* Var. **pseudo-catinatum** (Yorke and Macfie, 1919) Ihle, 1922.

Synonym :—*Cylicostomum pseudo-catinatum* Yorke and Macfie, 1919.

This form, which was originally described as a distinct species, is now generally considered not more than a variety of *T. catinatum*. The specimens described by Yorke and Macfie were small (male 5.2–6.6 mm. long and 0.26 mm. thick, female 6.1–7.7 × 0.32 mm.), but individuals may occur of a size intermediate between these and the typical form. The buccal capsule measured 0.0225–0.029 mm. in length and 0.034–0.0475 mm. in greatest diameter. The œsophagus measured 0.314–0.349 mm. in length in the male and 0.322–0.363 mm. in the female. Ihle, however, observed specimens, which he ascribes to this variety, in which it measured up to 0.37 mm. in the male and 0.4 mm. in the female. The tail of the female measures, according to Yorke and Macfie, on the average 0.069 mm., and the distance from vulva to anus 0.061 mm.

Apart from measurements, the main difference between this variety and the typical form is held to lie in the appendages of the genital cone in the male. These, as described by Yorke and Macfie, consist of two pairs of prominent, conical processes. In the typical form, as described by Looss, there is one pair of blunt processes with notched outlines. As has been pointed out by Boulenger (1921, *a*) and by Theiler (1923), there is a good deal of variation in the form of these appendages, and it seems doubtful whether they should be regarded as having varietal significance.

11. **Trichonema (Cylicocercus) goldi** (Boulenger, 1917).

Synonyms :—*Cylichnostomum goldi* Boulenger, 1917 ; *Cylicostomum goldi* Boulenger, 1921 ; *Cylicostomum (Cylicocercus) goldi* Ihle, 1922.

Host :—This species has been recorded from the horse in the Punjab by Boulenger.

The male measures 5.2–7.5 mm. in length and 0.23–0.3 mm. in maximum thickness, the female 6–9.75 mm. and 0.28–0.45 mm. respectively. The mouth-collar is high and marked off by a constriction. The buccal capsule is shallow and somewhat narrowed in front, and measures 0.02–0.032 mm. in length and 0.045–0.06 mm. in width. The dorsal gutter is represented by a small tubercle at the base. The external leaf-crown contains 20 to 22 elements, the internal leaf-crown about 36. The œsophagus is 0.3–0.5 mm. long. The excretory pore and cervical papillæ are situated at 0.25–0.3 mm. from the anterior extremity, about half-way between the nerve-ring and the posterior end of the œsophagus.

The dorsal lobe of the bursa is broad and rounded. The posterior end of the female is bent dorsally almost at right angles to the body, and the tail measures 0.095–0.145 mm. The vulva is situated at 0.06–0.15 mm. from the anus. The average size of the eggs is 0.1×0.05 mm.

12. *Trichonema (Cylicocercus) pateratum* (Yorke and Macfie, 1919).

Synonyms:—*Cylicostomum pateratum* Yorke and Macfie, 1919; *Cylichnostomum cymatostomum* Kotlán, 1919; *Cylicostomum cymatostomum* Kotlán, 1919; *Cylicostomum (Cylicocercus) pateratum* Ihle, 1922.

Host:—Boulenger records a single specimen from the colon of a horse at Sargodha, Punjab.

The male measures 8–11 mm. in length and 0.38–0.6 mm. in maximum thickness, the female 8.4–15 mm. and 0.39–0.7 mm. respectively. The mouth-collar is high and marked off by a constriction. When fully extended its height is greater dorsally and ventrally than laterally. The lateral cephalic papillæ are prominent. The oral aperture is elliptical, with its longer axis dorso-ventral. The buccal capsule is elliptical in transverse section. In lateral view its walls diverge anteriorly, while in dorso-ventral view they are almost parallel or even converge anteriorly. The capsule measures 0.025–0.028 mm. in length and 0.08–0.097 mm. in maximum width. The dorsal gutter does not project into the capsule. The external leaf-crown contains 20 to 25 elements. The internal leaf-crown consists of numerous long, narrow elements arising from a sinuous line at about the middle of the capsule. The œsophagus is 0.53–0.76 mm. long. The excretory pore and cervical papillæ are situated immediately behind the nerve-ring, at 0.3–0.36 mm. from the anterior extremity.

The bursa is relatively short and without a distinct dorsal lobe. The posterior end of the female is bent dorsally at

right angles to the body. The tail measures 0.105–0.143 mm. in length, and the vulva is situated at 0.091–0.123 mm. from the anus. The eggs measure 0.088–0.1 × 0.04–0.044 mm.

2. Genus **POTERIOSTOMUM** Quiel, 1919.

Synonym :—*Hexodontostomum* Ihle, 1920.

Elements of external leaf-crown numerous, those of the internal leaf-crown large and broad when seen from the exterior. Sometimes six of the latter elements are longer than the rest. Postero-lateral ray of bursa has an accessory branch. The externo-dorsal ray and the two pairs of branches of the dorsal ray leave the main stem in its anterior half, and run almost at right angles to it. The dorsal ray is bifurcate only as far as the point of origin of the more posterior pair of accessory branches. Tail of female long, straight and free from swellings. Adults parasitic in the large intestine of Equidæ.

Genotype :—*Poteriostomum imparidentatum* Quiel, 1919.

1. **Poteriostomum imparidentatum** Quiel, 1919. (Figs. 127 & 128.)

Synonyms :—*Poteriostomum pluridentatum* Quiel, 1919; *Hexodontostomum markusi* Ihle, 1920; ? *Cylichnostomum zebrae* Turner, 1920.

Host :—This species was found once (a single specimen) by Boulenger in the colon of a horse at Sargodha, Punjab.

The male measures 11–14 mm. in length and 0.6–0.76 mm. in maximum thickness, the female 13–21 mm. and 0.9–1.15 mm. respectively. The mouth-collar is high and distinctly marked off by a constriction. It has a diameter of 0.3–0.35 mm. The mouth is dorso-ventrally elongate. The buccal capsule is elliptical in section, with its longer axis dorso-ventral. It measures 0.052–0.07 mm. in length and 0.15–0.22 mm. in width. Its walls converge anteriorly and increase gradually in thickness posteriorly. The dorsal gutter extends to about the middle of the capsule. The external leaf-crown contains about 72 to 80 or more small, pointed elements; the internal leaf-crown about 36 to 50 long and bluntly-pointed elements, six of which are much longer than the rest. The œsophagus is 0.63–0.8 mm. long. The excretory pore and cervical papillæ are situated at or behind the middle of the œsophagus.

The bursa of the male is short and broad, without a distinct dorsal lobe. The tail of the female is 0.76–1 mm. long, straight and tapering to the tip, which is blunt. The vulva is situated at 0.68–0.9 mm. from the anus. The vagina is short (0.72 mm.)

Fig. 127.

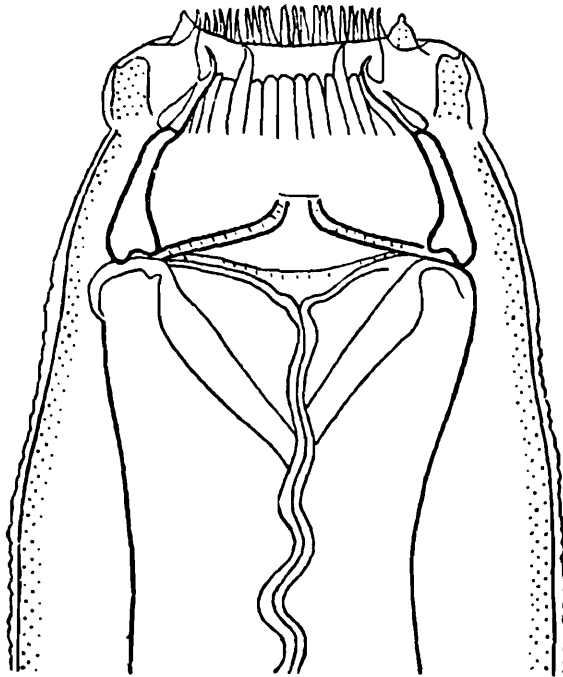

Fig. 128.

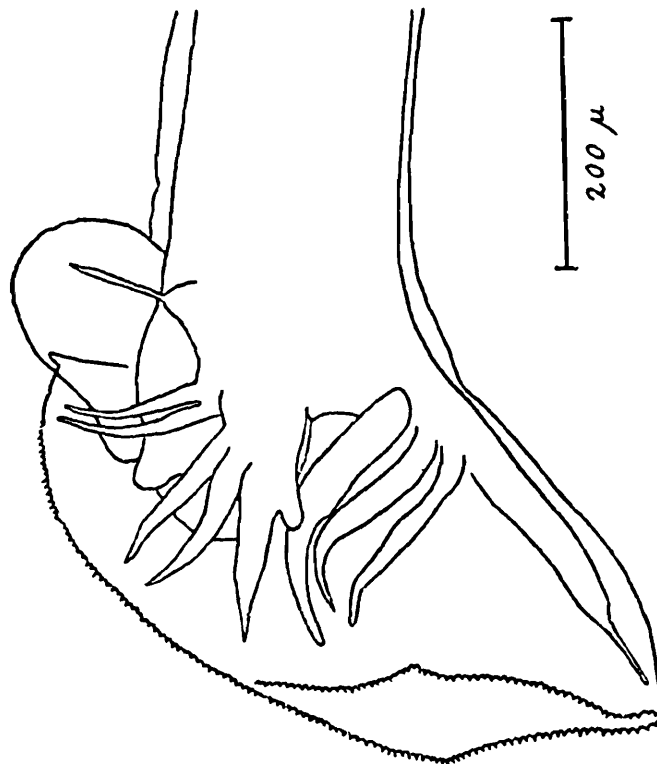

Fig. 127.—*Poteriosomum imparidentatum*. Anterior end ; ventral view.
(After Yorke and Macfie.)

Fig. 128.—*Poteriosomum imparidentatum*. Bursa of male ; lateral view.
(After Theiler.)

3. Genus **MURSHIDIA** Lane, 1914.

Synonyms* :—*Pteridopharynx* Lane, 1921; *Memphisia* Khalil, 1922; *Henryella* Neveu-Lemaire, 1924; *Pterygopharynx* Witenberg, 1925; ? *Buissonia* Neveu-Lemaire, 1924.

Body tapering anteriorly. In the male the thickest portion of the body may be just anterior to the bursa. Mouth-collar typically prominent laterally, incised dorsally and ventrally, so as to form two lateral "lips." External leaf-crown composed of numerous fine elements originating along a curved line and shorter dorsally and ventrally than laterally, thus giving to the mouth the shape of a dorso-ventral slit. Buccal capsule more or less cylindrical, in some species with two or more small teeth at its base. The cuticular lining of the sectors of the œsophagus may or may not have a plumose structure. Antero-lateral ray of bursa divergent from the other lateral rays. Postero-lateral and externo-dorsal rays frequently with a dorsal boss or accessory branch. Dorsal ray typically with two pairs of accessory branches, which may be partially fused. Spicules long and slender. An accessory piece present. Vulva close to anus. Uterine branches parallel. Adults parasitic in the alimentary canal of elephants, rhinoceroses and warthogs.

Genotype :—*Murshidia murshida* Lane, 1914.

Key to Species.

- | | |
|---|----------------------------|
| Spicules of male less than 1 mm. long, with fine, barbed points | <i>indica</i> , p. 281. |
| Spicules of male more than 1 mm. long. | 1. |
| 1. Each spicule with a small, posteriorly-directed spur near the tip; œsophagus about 0.5–0.6 mm. long | <i>murshida</i> , p. 278. |
| Each spicule with tip shaped like the head of a golf-club, without posterior spur; œsophagus about 0.9–1 mm. long | <i>falcifera</i> , p. 280. |

1. **Murshidia murshida** Lane, 1914. (Fig. 129.)

Host :—Indian elephant (cæcum); obtained by Lane from various parts of India. Specimens in the British Museum (Natural History) from Ceylon.

* Baylis and Daubney (1926), in discussing the affinities between *Murshidia*, *Pteridopharynx* and the other genera mentioned here, pointed out the probability that all these forms were congeneric. Yorke and Maplestone (1926) have gone into the question carefully and have independently concluded that, with the possible exception of *Buissonia*, all these names should be regarded as synonyms of *Murshidia*. Their conclusion, with the slight modifications which it entails in the generic diagnosis, is adopted here.

The male measures about 18–20 mm. in length and 0.6 mm. in maximum thickness, the female about 22–28 mm. and 0.7–0.9 mm. respectively. The cuticular striations are at intervals of 7μ . The buccal capsule measures 0.075–0.12 mm. in diameter. The external leaf-crown contains 60 elements. The œsophagus is 0.5–0.57 mm. long. The nerve-ring is

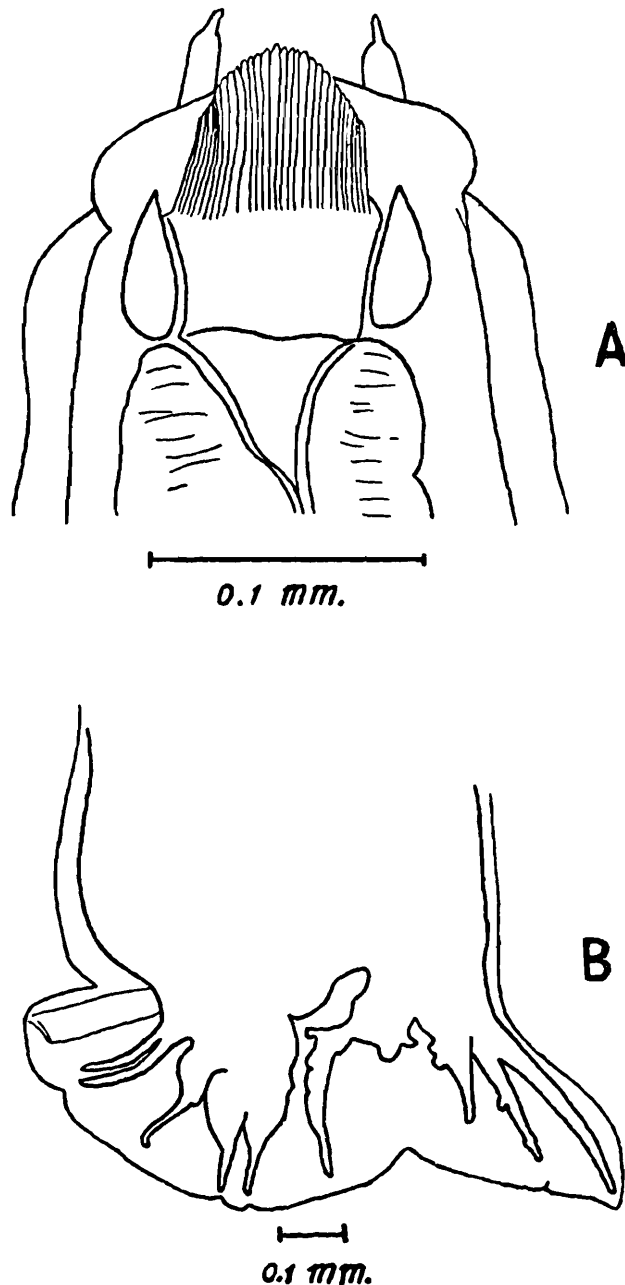

Fig. 129.—*Murshidia murshida*. A, anterior end, viewed from left side; B, bursa of male, lateral view. (After Lane.)

situated at 0.3 mm., the excretory pore at 0.8 mm., and the cervical papillæ at 0.85 mm., from the anterior end.

The lateral rays of the bursa of the male have swollen bases. The three branches of each half of the dorsal ray are at about equal distances. The spicules are about 1.3 mm. long, and

their tips are bent dorsally. At the angle there is a small, posteriorly-directed spur. The tail of the female is 1.6–2.2 mm. long, and tapers to a slender point. The vulva is situated at 2.3–2.9 mm. from the posterior end, and has rather prominent lips. The vagina measures 0.5 mm. in length, the ovejectors 0.375 mm. and the uterine branches 5.5 mm., according to Lane. Mature eggs were not observed by Lane. According to Witenberg (1925) they measure 0.072×0.048 mm.

2. *Murshidia falcifera* (Cobbold, 1882) Lane, 1915.

Synonyms:—*Strongylus falcifer* Cobbold, 1882; *Cylicostoma falcifer* Mitter, 1912; *Cylicostomum falciferum* Railliet, Henry and Bauche, 1914; *Murshidia falcifer* Lane, 1914.

Host:—Indian elephant (cæcum); recorded from various parts of India by Lane, from Burma by Evans and Rennie, and from the Andamans by Bhalerao. Specimens in the British Museum (Natural History) from Ceylon.

The male measures 22–27 mm. in length and about 0.9 mm. in maximum thickness, the female 24–32 mm. and about 1 mm. respectively. The cuticular striations are at intervals of 7μ . The buccal capsule measures 0.1–0.13 mm. in diameter. The external leaf-crown contains, according to Lane, 80 elements on each side, or, according to Witenberg (1925), 40 on each side (80 in all). The œsophagus is about 0.9–1 mm. long. The nerve-ring is situated at about 0.5 mm. from the anterior end, the excretory pore at the level of the posterior end of the œsophagus, and the cervical papillæ a little behind this, at 1.2 mm. from the anterior end.

The bases of the lateral rays of the bursa are not swollen. Of the three branches of each half of the dorsal ray, the two anterior are close together and somewhat separated from the posterior. The spicules are about 1.5 mm. long according to Lane, or 1.69–1.79 mm. according to Witenberg. Their tips are bent dorsally and shaped like the head of a golf-club, without a posterior spur. The shafts are curved just before the terminal bend. "The middle third of each spicule is provided with two incurved alæ, ridged obliquely in a plumose fashion, forming a gutter; on the last third of the spicule these alæ fuse, forming a canal which opens at the curved end of the spicule. There is a small S-shaped, curved accessory piece, 0.05 mm. long, visible from the sides only. A telamon is present" (*Witenberg*).

The tail of the female is 1.59–2.2 mm. long, and has a pair of papillæ at 1.5 mm. from the tip. The vulva is situated at about 3 mm. from the posterior end. Its lips are usually only slightly thickened. The eggs measure 0.05×0.03 mm. (Lane), or 0.084×0.041 mm. (*Witenberg*).

3. *Murshidia indica* (Ware, 1924) Yorke and Maplestone, 1926.
(Fig. 130.)

Synonym :—*Pteridopharynx indica* Ware, 1924.

Host :—Indian elephant ; Malabar, South India.

The male measures 15–18 mm. in length and 0.6 mm. in maximum thickness, the female 19–22 mm. and 0.7 mm. respectively. The cuticular striations are at intervals of $12\ \mu$. The mouth-collar is marked off by a groove. The buccal capsule measures 0.06 mm. in length and 0.1 mm. in width.

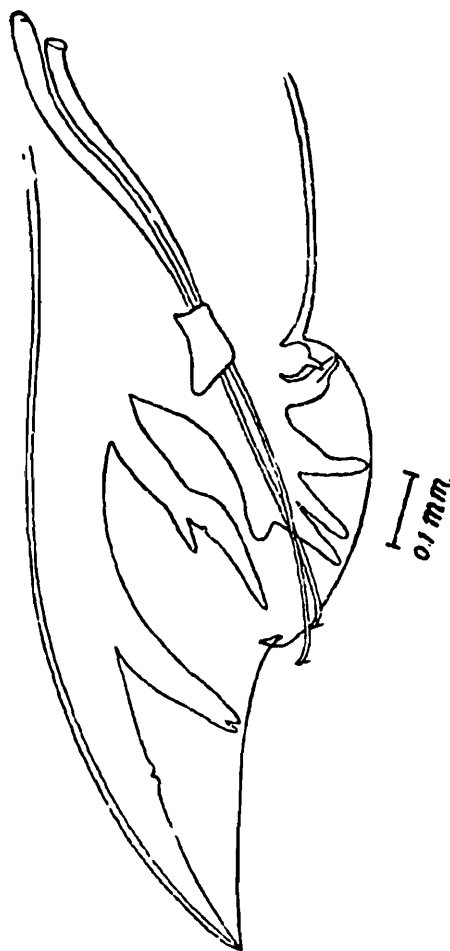

Fig. 130.—*Murshidia indica*. Bursa of male ; lateral view.
(After Ware.)

The oral aperture is rectangular. The external leaf-crown contains 42 elements, which are united for about half their length. The œsophagus is 0.52 mm. long in the male, 0.63 mm. in the female. For a distance of about 0.08 mm. at the anterior end its cuticular lining has a plumose structure. The nerve-ring is situated at 0.25 mm., the excretory pore at 0.88–1.08 mm., and the slender, anteriorly-directed cervical papillæ at 0.98–1.2 mm., from the anterior extremity.

The spicules measure 0.85 mm. in length, and are slender and provided with finely plumose alæ except at the tips. The tip

of each spicule is bent dorsally and has a very fine, barbed point. The accessory piece is saddle-shaped and measures 0.1 mm. in length and 0.05 mm. in width. The body of the female is suddenly constricted behind the vulva. The tail is 0.8–1 mm. long, and tapers to a fine point. The vulva is situated at about 0.1 mm. from the anus, opens posteriorly, and is covered ventrally by a large prominence of its anterior lip. The uterine branches originate at a distance of 0.55 mm. from the vulva. Each has a powerful ovejector at about 1.28 mm. from the vulva. The eggs measure 0.06×0.035 mm. (average).

4. Genus **KHALILIA** Neveu-Lemaire, 1924.

Synonyms :—*Amira* Lane, 1914, *nec* Girault, 1913; *Amiroides* Strand, 1929.

Cuticle thick, sometimes with bosses in front of the bursa in the male. External and internal leaf-crowns present. Buccal capsule very shallow, with thick walls. Œsophagus hourglass-shaped, with a large œsophageal funnel and lined almost throughout with thickened cuticle. Dorsal lobe of bursa may be enormously elongate. Prebursal papillæ long and slender, appearing as additional rays. All the bursal rays relatively long and slender, more particularly the dorsal, which is cleft almost to its base. Accessory branches of dorsal ray typically two pairs, arising from the bifurcate portion. One pair may be much reduced. Spicules extremely long and filiform. An accessory piece present. Vulva close to anus. Uterine branches parallel. Adults parasitic in the alimentary canal of elephants and rhinoceroses.

Genotype :—*Khalilia rhinocerotis* Neveu-Lemaire, 1924.

1. **Khalilia pileata** (Railliet, Henry and Bauche, 1914). (Fig. 131.)

Synonyms :—*Cylicostomum pileatum* Railliet, Henry and Bauche, 1914; *Amira omra* Lane, 1914; *Amira pileata* Lane, 1915.

Host :—Indian elephant (cæcum); recorded by Lane from Murshidabad and Travancore.

The male measures 9.5–10 mm. in length and 0.4–0.6 mm. in maximum thickness, the female 11.5–14 mm. and 0.55–0.75 mm. respectively. The cuticle has transverse striations at intervals which, in the œsophageal region, may measure up to 30μ . The buccal capsule measures 0.025–0.04 mm. in length and up to 0.128 mm. in width posteriorly. Each of the leaf-crowns contains 32 to 36 elements, those of the external crown being stout. The œsophagus is very short (0.55–

0.6 mm.), and is composed of two swellings of which the posterior is slightly the larger, separated by a constriction in which lies the nerve-ring. The excretory pore is situated just behind the œsophagus, and the long, prominent cervical papillæ a little behind the excretory pore.

In the male the cuticle is swollen ventrally in front of the bursa into a large boss. The dorsal lobe of the bursa and the

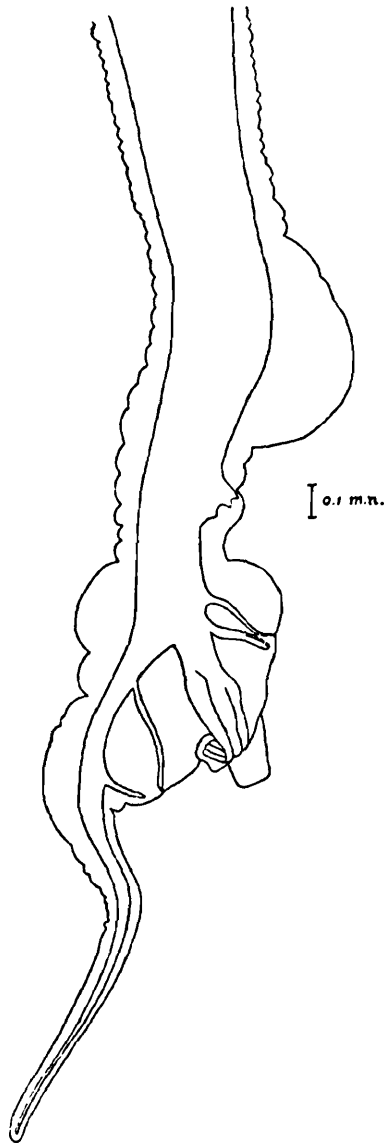

Fig. 131.—*Khalilia pileata*. Bursa of male; lateral view.
(After Lane.)

dorsal ray are very long. The latter measures about 1.7 mm. in length and bifurcates at about 0.25 mm. from its base. Each main branch gives off, according to Khalil (1922, *b*), two very short lateral branches not far from the point of bifurcation (of these only one was described and figured by Lane). The spicules are slender and measure, according to Lane, 3.5 mm. in length. Lane states that there is no accessory piece.

Khalil, however, has described the presence of an accessory piece 0.165 mm. long.

The tail of the female is rather blunt, measures 0.45–0.5 mm. in length and bears a pair of papillæ at 0.25 mm. from the tip. The vulva is situated at 0.7–0.75 mm. from the posterior extremity. The vagina runs forward for a distance of about 2 mm. before giving off the uterine branches, which also run forward. The eggs measure 0.06–0.073 × 0.03–0.045 mm.

5. Genus **QUILONIA** Lane, 1914.

Synonyms :—*Evansia* Railliet and Henry, 1913, *nec* Scott, 1906 ; *Nematevansia* Ihle, 1919 ; *Paraquilonia* Neveu-Lemaire, 1924.

External leaf-crown composed of a few long elements. Internal leaf-crown present or absent. Buccal capsule a wide, shallow ring, its wall widely separated from the lining of the mouth-cavity, which is bounded by the elements of the leaf-crowns. The latter extend backwards and are continuous with the cuticle lining the œsophageal funnel. Teeth may be present at the base of the buccal capsule. Lateral rays of the bursa rather divergent from each other. The externo-dorsal rays spring from the median stem of the dorsal ray towards its base. Dorsal ray cleft for about one-third of its length. Each of its main branches gives off two small accessory branches. An accessory piece present. Vulva in posterior third of body. Uterine branches opposed, but the posterior branch turns and runs anteriorly. Adults parasitic in the intestine of elephants and rhinoceroses.

Genotype :—*Quilonia renniei* (Railliet and Henry, 1913).

Key to Species.

External leaf-crown contains 18 elements ; dorsal ray of bursa about 0.35 mm. long	<i>renniei</i> , p. 284.
External leaf-crown contains 10 elements ; dorsal ray of bursa about 0.85 mm. long	<i>travancra</i> , p. 286.

1. **Quilonia renniei** (Railliet and Henry, 1913) Railliet, Henry and Bauche, 1915. (Fig. 132.)

Synonyms :—*Evansia renniei* Railliet and Henry, in Railliet, Henry and Joyeux, 1913 ; *Quilonia quilonia* Lane, 1914 ; *Nematevansia renniei* Ihle, 1919.

Host :—Indian elephant (cæcum) ; recorded from Travancore by Lane, and from Burma by Evans and Rennie.

The following description is taken mainly from Lane (1914, *a*), with the addition of a few details given by Khalil (1922, *b*).

The male measures about 15 mm. in length and 0.6 mm. in maximum thickness, the female about 20 mm. and 0.85 mm. respectively. The cuticular striations are at intervals of about $31\ \mu$. The mouth-collar has a diameter of about 0.2 mm., the buccal capsule of 0.16 mm. The external leaf-crown contains 18 elements, which project beyond the surface of the

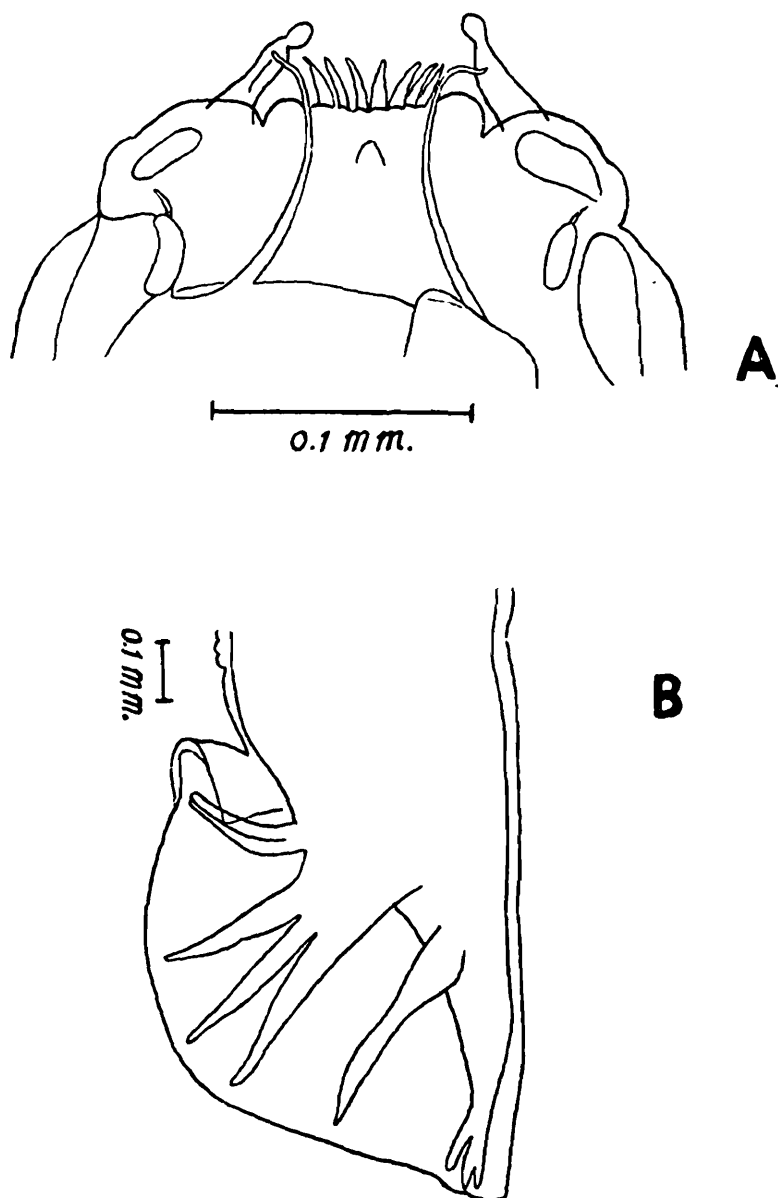

Fig. 132.—*Quilonia renniei*. A, anterior end, viewed from left side ; B, bursa of male, lateral view. (After Lane.)

head. The œsophagus is about 0.8 mm. long. The nerve-ring is situated at 0.4 mm., the excretory pore at 0.65 mm., and the cervical papillæ at 0.85 mm., from the anterior extremity.

The dorsal ray of the bursa is comparatively short (about 0.35 mm.). The lateral and ventral rays are slender. The spicules measure 0.825 mm. in length, the accessory piece 0.175 mm.

The tail of the female is sharply pointed and measures 2 mm. in length. It bears a pair of papillæ at 1.2 mm. from the tip. The vulva is situated at 6 mm. from the posterior end. The eggs measure, according to Khalil, $0.075-0.0815 \times 0.0375$ mm.

2. *Quilonia travancra* Lane, 1914.

Synonyms :—*Evansia travancra* Lane, 1915; *Nematevansia travancra* Ihle, 1919.

Host :—Indian elephant; recorded from Travancore by Lane.

The male measures about 18 mm. in length and 0.65 mm. in maximum thickness, the female 20 mm. and 0.9 mm. respectively. The cuticular striations are at intervals of 37μ . The mouth-collar measures 0.26 mm., the buccal capsule 0.18 mm. in diameter. The external leaf-crown contains 10 elements, which do not project beyond the surface of the head. The œsophagus is about 0.75 mm. long. The nerve-ring is situated at 0.45 mm., the excretory pore and cervical papillæ at 1 mm., from the anterior extremity.

The dorsal ray of the bursa is comparatively long (about 0.85 mm.). All the rays are stouter than in *Q. renniei*. The spicules are about 0.9 mm. long, and have a sinuous outline near the tip. The accessory piece is 0.2 mm. long.

The tail of the female measures 2.3 mm. in length, and has a blunt tip. The caudal papillæ are situated at 0.9 mm. from the tip. The vulva is at a distance of 5.8 mm. from the posterior end. The eggs measure 0.07×0.045 mm.

6. Genus **KILULUMA** Skrjabin, 1916.

Mouth-collar divided by grooves into six sections, each bearing one of the cephalic papillæ. Buccal capsule shallow, cylindrical, with thick walls. An external leaf-crown of six elements present, these arising from the base of the buccal capsule and projecting from the mouth-opening. Prebursal papillæ of male appear as an additional pair of ventral rays within the bursa. Externo-dorsal rays originate separately from the dorsal ray and appear as an extra pair of lateral rays. Dorsal ray with one pair of accessory branches, arising high up on the main stem. The tips of these branches may be bifurcate. Spicules broad, alate, and twisted distally. An accessory piece present. Vulva near the anus. Uterine branches parallel. Adults parasitic in the alimentary canal of rhinoceroses.

Genotype :—*Kiluluma stylosa* (v. Linstow, 1907).

1. *Kiluluma stylosa* (v. Linstow, 1907) Skrjabin, 1916.

Synonym :—*Deletrocephalus stylosus* v. Linstow, 1907.

Host :—This species is recorded both by v. Linstow and by Skrjabin from the stomach of *Rhinoceros africanus* in East Africa. Baylis and Daubney (1923) referred to it some specimens from the stomach of *Rhinoceros unicornis* [*R. indicus*] from Janakpur, Nepal.

The description given by v. Linstow (1907, *a*) was considerably amplified by Skrjabin (1916, *b*), who assumed that he was dealing with the same species. Thapar, however, has described a whole series of supposedly distinct species from the African rhinoceros. The differences between several of these are so slight that the species are regarded by Taylor (1925, *a*) as synonymous, but it is not certain whether any of them are identical with the species *stylosa* of either of the earlier describers, nor can it be considered certain that Skrjabin's species was identical with v. Linstow's.

The male of *K. stylosa*, according to v. Linstow, measures 16 mm. in length and 0.77 mm. in thickness, the female 20–26 mm. and 1.38 mm. respectively. Skrjabin gives 19 mm. and 0.935 mm. for the male, 21 mm. and 1.12 mm. for the female. The length of the œsophagus is given by v. Linstow as $\frac{1}{29}$ of the total length in the male, $\frac{1}{34}$ in the female [*i. e.* about 0.55 mm. and 0.76 mm. respectively]. Skrjabin gives 0.578 mm. in the male, 0.595 mm. in the female. The cervical papillæ, according to v. Linstow, are at 1.1 mm. from the anterior end; according to Skrjabin, at 0.85 mm. in the male and at 0.952 mm. in the female. They have long, flagellate terminations. The nerve-ring, according to Skrjabin, is at 0.2–0.22 mm., and the excretory pore (in the female) at 0.88 mm., from the anterior end.

The spicules are 3.2 mm. long according to v. Linstow, or 2.72 mm. according to Skrjabin. Their tips are pointed according to the former, spatulate according to the latter author. The tail of the female, according to v. Linstow, measures 0.35 mm. in a specimen 20 mm. long. Skrjabin gives the length of the tail as 0.374 mm. The vulva is situated at a distance of 0.48 mm. (v. Linstow) or 0.52 mm. (Skrjabin) from the posterior extremity. The eggs measure about 0.1×0.055 mm. according to both authors.

7 Genus **BOURGELATIA** Railliet, Henry and Bauche, 1919.

Buccal capsule shallow and cylindrical, its wall thick and composed of two portions, of which the posterior is more or less continuous with the cuticular lining of the wide, shallow œsophageal funnel. External leaf-crown composed of about twenty large, pointed elements; internal leaf-crown of the same number of bifid elements. Ventral rays of bursa parallel and closely applied to each other. Bursa incised near the tips of the ventral rays, giving the appearance of a pair of additional lobes. Antero-lateral ray somewhat shorter than, but not divergent from, the remaining lateral rays. Externodorsal rays originate high up on the main dorsal stem. Dorsal ray cleft for almost half its length. A single accessory branch springs from each main branch. An accessory piece present. Vulva close to anus. Uterine branches parallel. Adults parasitic in the intestine of pigs.

Genotype :—*Bourgelatia diducta* Railliet, Henry and Bauche, 1919.

1. ***Bourgelatia diducta*** Railliet, Henry and Bauche, 1919.
(Figs. 133 & 134.)

Host :—Domestic pig (cæcum). This species, which was originally recorded from Annam, is also recorded from Bengal

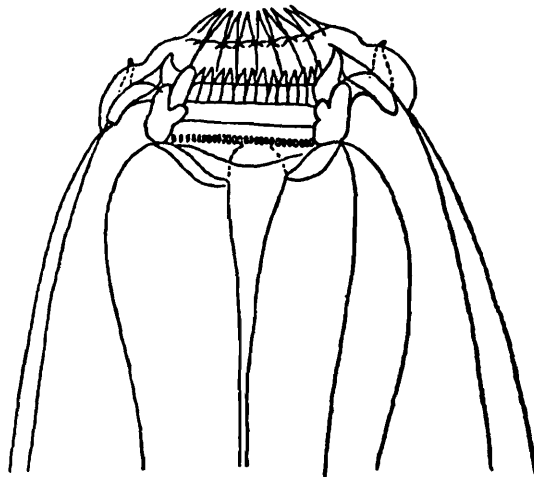

Fig. 133.—*Bourgelatia diducta*. Anterior end; dorsal view. (From Hall, after Railliet, Henry and Bauche.)

by Maplestone, who found it to be present in 42 out of 49 pigs examined in Calcutta.

The following description is taken from the account given by Railliet, Henry and Bauche, supplemented by that of Maplestone.

The male measures 8.85–12.5 mm. in length and 0.4–0.6 mm. in maximum thickness, the female 10–13.5 mm. and 0.5–0.64 mm. respectively. The cuticular striations are at intervals of 5–7 μ in the middle region of the body. The buccal capsule measures 0.036–0.04 mm. in length and 0.068–0.072 mm. in width. It is composed of an anterior ring-shaped portion, surrounding the bases of the leaf-crowns, and a posterior cup-shaped portion into which the former fits. Each of the leaf-crowns contains 21 elements, those of the internal crown being bifid. The oesophagus is club-shaped and measures about 0.65–0.95 mm. in length in the male, 0.75–0.1 mm. in

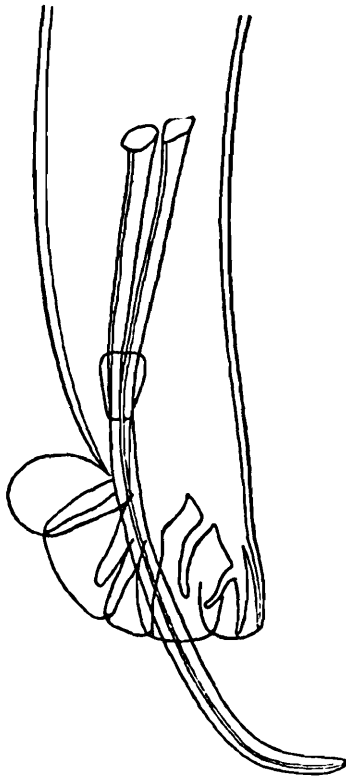

Fig. 134.—*Bourgelatia diducta*. Posterior end of male; lateral view. (From Hall, after Railliet, Henry and Bauche.)

the female. The excretory pore is situated at 0.268–0.36 mm., and the cervical papillæ at 0.396–0.55 mm., from the anterior end.

The bursa of the male is marked off by notches into dorsal, lateral and ventral lobes. The genital cone is a pointed structure with a large papilla on each side of its base. The spicules, according to Maplestone, "appear to emerge through a separate canal dorsal to the intestinal opening." They measure 1.12–1.33 mm. in length and have transversely striated alæ. The accessory piece, according to Railliet, Henry and Bauche, is about 0.135 mm. long and of ill-defined shape. According to Maplestone it is a definite structure 0.148–0.16 mm. long, and the ring-shaped structure figured by

the original describers is probably the anterior edge of a funnel-shaped telamon.

The tail of the female is 0.297–0.376 mm. long according to Maplestone, or 0.4–0.425 mm. according to Railliet, Henry and Bauche. The caudal papillæ, according to the latter authors, are asymmetrically placed, at 0.11–0.14 mm. from the tip. The vulva is prominent, and is situated at 0.95–1 mm. from the posterior end, according to the original description, or at 0.535–0.554 mm. from the anus [about 0.83–0.93 mm. from the posterior end] according to Maplestone. Railliet *et al.* give the dimensions of the eggs as 0.069–0.077 × 0.038–0.042 mm. ; Maplestone gives 0.058–0.06 × 0.036–0.038 mm.

Subfamily CÆSOPHAGOSTOMINÆ Railliet, 1915.

Buccal capsule cylindrical or large and subglobular. A transverse ventral cervical groove present. The cuticle of the anterior end may be dilated to form a cephalic vesicle, limited on the ventral side by the cervical groove. Parasites of the alimentary tract of mammals.

Key to Genera.

- | | |
|--|------------------------------|
| Mouth directed antero-ventrally; buccal capsule deep and subglobular. | CHABERTIA, p. 308. |
| Mouth directed anteriorly; buccal capsule shallow and ring-shaped | 1. |
| 1. Cervical groove completely encircles the neck; cephalic inflation extends posteriorly to form dorsal and ventral flaps. | BOSICOLA, p. 305. |
| Cervical groove usually limited to the ventral and lateral surfaces; cephalic inflation, when present, does not form dorsal and ventral flaps. | [p. 290.
CÆSOPHAGOSTOMUM, |

1. Genus CÆSOPHAGOSTOMUM Molin, 1861.

Synonyms:—*Hypostomum* Stewart, 1898; *Cæsophagostomoides* Schwartz, 1928.

Anterior end usually with a cuticular inflation or vesicle, limited behind, at the level of the excretory pore, by a transverse ventral groove, which extends for a varying distance on to the lateral surfaces. Lateral alæ may be present, originating at the level of the groove. An external and usually an internal leaf-crown present. The œsophageal funnel occasionally contains three teeth. Medio-lateral and postero-lateral rays of bursa closely applied to each other and somewhat divergent from the antero-lateral ray. Externodorsal rays originate high up on the main stem of the dorsal

ray, which is bifurcate in its posterior two-fifths. A much-reduced accessory branch arises from each of the main branches. An accessory piece present. Vulva near the anus. Uterine branches parallel. Adults parasitic in the intestine of mammals (chiefly Ungulates and Primates).

Genotype :—*Æsophagostomum dentatum* (Rudolphi, 1803).

The genus *Æsophagostomum* was divided by Railliet and Henry in 1913 into three subgenera, *Æsophagostomum*, *Proteracrum*, and *Hysteracrum*. To these a fourth, *Conoweberia*, was added by Ihle in 1922. Goodey (1924), Thornton (1924) and Baylis and Daubney (1926) have all expressed the view that such a division of the genus is unnecessary. Travassos and Vogelsang (1932) have recently raised the question again, and have not only revived the four subgenera already mentioned, but have added two further subgenera, *Bosicola* Sandground, 1929, and *Ihleia* Travassos and Vogelsang.

The name *Bosicola* was used in a generic sense by Sandground for a form which was subsequently admitted to be identical with *Æsophagostomum radiatum* (Rud.). This species and two other forms, *Bourgelatioides traguli* Chandler and *Æsophagostomum curvatum* Maplestone, appear to the writer to have in common several characters which mark them off distinctively from all the other species of *Æsophagostomum*, and it seems justifiable to place them together in a group of generic rank, for which the name *Bosicola* must be retained on the ground of priority.

The species *Æsophagostomum tridentatum* Maplestone does not fall naturally into any of the subgenera mentioned, but appears to be a typical *Æsophagostomum* except for the special development of the œsophageal funnel. Apart from *Bosicola*, however, the subgenera are based on characters which are, in the writer's opinion, of specific value only. These characters are the position of the cervical papillæ, the shape and degree of development of the œsophageal funnel and whether or not it contains teeth, the number of elements in the external leaf-crown, and the degree of development of the lateral alæ.

The genus *Æsophagostomoides* Schwartz, 1928, is here treated as a synonym of *Æsophagostomum*. It is stated to differ from the latter chiefly in lacking a ventral cervical groove and in having a simpler type of ovejector apparatus in the female. But both Schwartz, in the genotype, and Maplestone, in *O. traguli*, describe a definite constriction of the cuticle in the œsophageal region, and in view of the differences in the extent and degree of development of the cervical groove between species usually assigned to *Æsophagostomum*, it appears doubtful whether the condition found in these two

forms is of more than specific importance. The absence of the "kidney-shaped pars ejectrix" of the ovejector, usually present in *Æsophagostomum*, can, by itself, hardly be regarded as a generic character.

Key to Species.

Parasites of swine	1.
Parasites of ruminants .	4.
Parasites of Primates	7.
1. Spicules of male less than 1 mm. long	2.
Spicules of male more than 1 mm. long .	3.
2. External leaf-crown contains 9 elements.	[p. 294.
External leaf-crown contains 30 elements.	<i>quadrispinulatum,</i>
3. External leaf-crown contains 9 elements.	<i>maplestonei</i> , p. 295.
External leaf-crown contains 14 to 16 elements.	<i>dentatum</i> , p. 292.
4. Length of adult about 3 mm.	<i>brevicaudum</i> , p. 294.
Length of adult over 7 mm.	<i>traguli</i> , p. 304.
5. Cephalic inflation absent; spicules of male less than 1 mm. long	5.
Cephalic inflation present; spicules of male more than 1 mm. long	<i>columbianum</i> , p. 297.
6. External leaf-crown contains 18 elements.	6.
External leaf-crown contains 12 elements.	<i>venulosum</i> , p. 296.
External leaf-crown contains 10 elements.	<i>asperum</i> , p. 297.
7. Teeth in œsophageal funnel large and arising near its base	<i>indicum</i> , p. 299.
Teeth in œsophageal funnel small and arising near its anterior end	<i>tridentatum</i> , p. 303.
8. Spicules of male up to 1.6 mm. long	8.
Spicules of male up to 2 mm. long	<i>blanchardi</i> , p. 300.
	<i>ovatum</i> , p. 302.

1. *Æsophagostomum dentatum* (Rud., 1803) Molin, 1861.
(Fig. 135.)

Synonyms:—*Strongylus dentatus* Rudolphi, 1803; *Strongylus* (*Sclerostoma*) *dentatus* Rudolphi, 1809; *Sclerostoma dentatum* de Blainville, 1828; *Æsophagostomum subulatum* Molin, 1861; *Strongylus follicularis* Ostertag, in Olt, 1898.

Host:—This species is a common and widely-distributed parasite of the domestic pig, and has also been recorded from peccaries in America. Maplestone records it as occurring in small numbers in swine slaughtered in Calcutta.

The male measures 8–10 mm. in length and 0.2–0.3 mm. in maximum thickness, the female about 9.7–14.5 mm. and 0.4–0.5 mm. respectively. The cephalic inflation is well developed. The cervical groove extends some distance on to the lateral surfaces. Lateral alæ are absent. The buccal capsule has almost parallel sides. Its internal diameter is 0.036–0.042 mm. The external leaf-crown contains nine elements, which project beyond the oral aperture. The internal leaf-crown contains 18 small elements. The œsophagus is club-shaped and is not swollen at the anterior end.

It measures about 0.5 mm. in length. The cervical papillæ, which have bristle-like terminations, are situated towards the posterior end of the œsophagus, and the nerve-ring just in front of the cervical groove.

The spicules of the male are 1.15–1.32 mm. long. They are provided with alæ and taper to a blunt tip. The accessory piece is shaped somewhat like a trowel, the anterior portion representing the handle. It measures 0.116–0.14 mm. in length (average, according to Maplestone, 0.129 mm.). The tail of the female is tapering and measures 0.25–0.43 mm. in length. The vulva is situated at a distance of 0.28–0.39 mm. from the anus (or, according to Maplestone, 0.534–0.792 mm. from the posterior extremity), and is slightly prominent.

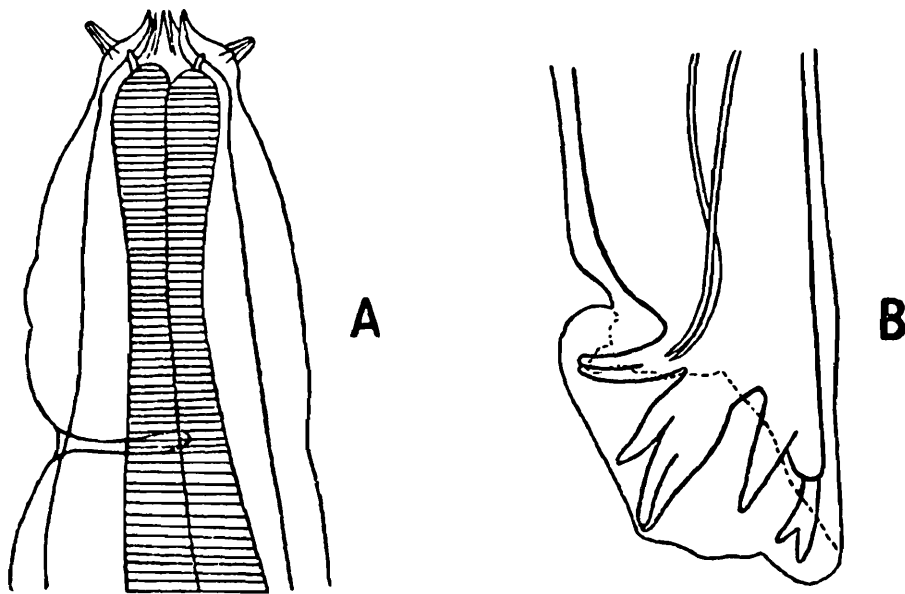

Fig. 135.—*Œsophagostomum dentatum*. A, anterior end, lateral view; B, posterior end of male, lateral view. (After Yorke and Maplestone.)

The vagina is about 0.2 mm. long. The eggs measure 0.07–0.074 × 0.04–0.042 mm. Their contents are segmenting at the time of laying.

The life-history of this and other species of the genus, so far as it is known, is briefly as follows. The eggs hatch after lying for a time in the open, and the larvæ there develop as far as the third stage, but retain the cuticle of the second moult. The larva, if swallowed at this stage by a suitable host, burrows into the intestinal wall and there forms a nodule, from which it subsequently escapes into the lumen of the intestine and becomes mature. Larvæ are sometimes carried by the blood-stream to the liver, but here they soon degenerate. According to Goodey, the larvæ of *O. dentatum* are not capable of penetrating the skin of the host.

2. **Æsophagostomum quadrispinulatum** (Marccone, 1901)
Alicata, 1935*.

Synonym :—*Æsophagostomum longicaudum* Goodey, 1925.

Host :—This species was originally recorded from the large intestine of the pig in New Guinea. It has since been found in the same host in other parts of the world, and has probably often been confused with *O. dentatum*. Maplestone (1930, a) records it from pigs slaughtered in Calcutta.

Goodey's description was based on immature specimens, and few measurements were given. Maplestone has given a further account of the species, from which most of the measurements in the following description are taken.

The worm closely resembles *O. dentatum* in general appearance. The male measures 6.56–8.85 mm. in length, the female 8.33–10.36 mm. The buccal capsule is somewhat wider posteriorly than anteriorly, and its walls are bent inwards at the anterior edge, forming an acute angle in optical section. The internal diameter of the capsule anteriorly is 0.04–0.044 mm., posteriorly 0.056–0.064 mm. The leaf-crowns are as in *O. dentatum*. The œsophagus measures, according to Goodey, 0.38–0.42 mm. in length, and a characteristic feature is that it has a small but distinct swelling at its anterior end. The cervical papillæ are situated somewhat behind the middle of the œsophagus.

The spicules measure 0.78–0.88 mm. in length according to Maplestone, or 0.91–0.95 mm. according to Goodey. The accessory piece is trowel-shaped, as in *O. dentatum*, and measures, according to Maplestone, 0.104–0.12 mm. in length (average 0.114 mm.). The tail of the female is 0.36–0.37 mm. long according to Maplestone, or 0.46–0.47 mm. according to Goodey. The vulva is situated at a distance of 0.38–0.52 mm. from the anus, or, according to Maplestone, 0.812–0.99 mm. from the posterior end. The eggs measure 0.048–0.052 × 0.028–0.031 mm. (Maplestone).

3. **Æsophagostomum brevicaudum** Schwartz and Alicata, 1930.

Synonym :—*Æsophagostomum suis* Maplestone, 1930.

Host :—Domestic pig (cæcum and large intestine). This species is recorded from the United States of America by Schwartz and Alicata. According to Maplestone, it is the commonest species in pigs slaughtered in Calcutta.

The male measures 6.2–8.75 mm. in length and about 0.3–0.45 mm. in maximum thickness, the female 6.4–11.4 mm. and about 0.3–0.48 mm. respectively. The worm is similar in general appearance to *O. dentatum*. The buccal capsule

* Journ. Parasitol. xxi, p. 215.

measures 0·016 mm. in length and about 0·04 mm. in width. As seen in optical section, its walls, according to Schwartz and Alicata, are separated by an annular groove into "a more or less triangular apical portion and a more or less spherical basal portion." The external leaf-crown contains 14 to 16 elements, the internal 28 to 32. The cephalic inflation is well marked. The cervical groove, which extends on to the sides, is situated at about 0·17–0·24 mm. from the anterior end. The œsophagus has a slight swelling anteriorly, and measures about 0·36–0·45 mm. in length in the male, 0·43–0·5 mm. in the female. The nerve-ring is situated at about the level of the cervical groove, and the cervical papillæ behind the middle of the œsophagus, at about 0·33–0·38 mm. from the anterior end.

The spicules are about 1–1·3 mm. long. The accessory piece is shaped as in *O. dentatum* and measures 0·098–0·12 mm. in length. The tail of the female is bent dorsally. Its length, according to Schwartz and Alicata, is only 0·081–0·12 mm., but Maplestone gives it as 0·356–0·515 mm. The vulva is situated at 0·19–0·225 mm. from the tip of the tail, according to the American authors. Maplestone states that it is at 0·614–0·792 mm. from the anus. The vagina is 0·218–0·285 mm. long. The eggs measure about 0·053–0·068 × 0·028–0·045 mm.

4. *Œsophagostomum maplestonei* (Schwartz, 1931) *emend.*
Schwartz, 1932.

Synonyms:—*Œsophagostomum conicum* Maplestone, 1930, *nec* Molin, 1861; *Œsophagostomum maplestoni* Schwartz, 1931; *Œsophagostomum conoides* Maplestone, 1931.

Host:—Domestic pig (cæcum and large intestine); found by Maplestone in 9 out of 49 pigs slaughtered in Calcutta, but never in large numbers.

The male measures 6·87–7·91 mm. in length and about 0·32–0·34 mm. in maximum thickness, the female 8·2–9·1 mm. and 0·45–0·5 mm. respectively. "The external appearance of the anterior end is quite distinctive, as the worm is relatively broad in proportion to its length; it tapers towards the anterior end from about the level of the cervical papillæ, and there is no distinct mouth-collar. The ventral cervical groove is deep and the anterior cuticular lip of the groove overhangs it" (*Maplestone*). The groove is situated at about 0·16–0·18 mm. from the anterior end. The cephalic inflation is not well marked. The walls of the buccal capsule are "comma-shaped" in optical section, with the broad end anterior. The capsule measures about 0·04 mm. in length and 0·08 mm. in width. "There is a distinct groove encircling its inner surface slightly anterior to the middle, from which

both leaf crowns appear to arise." Each leaf-crown contains 30 elements. The œsophagus (in the female) is about 0.67–0.71 mm. long. It is "relatively broad, with a distinct œsophageal funnel." The cuticular lining is produced into three ridges projecting into the lumen of the funnel. The cervical papillæ are situated at 0.46–0.48 mm. from the anterior end (in the female).

The spicules are 0.832 mm. long. The accessory piece is of the typical form. The posterior end of the female is straight and tapering. The tail measures 0.237–0.257 mm. in length. The vulva is situated at 0.317–0.356 mm. from the anus. The vagina is 0.06–0.064 mm. long. The eggs measure 0.06×0.032 mm.

5. *Œsophagostomum venulosum* (Rud., 1809) Railliet, 1885.

Synonyms:—*Strongylus venulosus* Rudolphi, 1809; *Strongylus ammonis* Rudolphi, 1819; *Œsophagostomum acutum* Molin, 1861; *Œsophagostoma inflatum* var. *ovis* Carita, 1887; [*Œsophagostomum* (*Hysteracrum*) *venulosum* Railliet and Henry, 1913].

Hosts:—This species occurs in the large intestine (more rarely in the small intestine and stomach) of various ruminants, including the goat, sheep, deer and camels, and is widely distributed. It has been recorded by Gaiger from sheep in India, and by Bhalerao from the "hill goat" or Himalayan ibex (*Capra sibirica*) at Muktesar, United Provinces.

The male measures 11–16 mm. in length and 0.3–0.4 mm. in maximum thickness, the female 13–24 mm. and 0.5–0.6 mm. respectively. The mouth-collar is in the form of a truncate cone, and is marked off by a distinct groove. The cephalic inflation is fairly well developed, but diminishes in width before the cervical groove, which usually extends only as far as the lateral lines, but according to Ransom may sometimes be traced right round the body. Narrow lateral alæ extend throughout nearly the whole length of the body. The buccal capsule, which is about five times as wide as long, is composed, according to Goodey, of a ring of 18 parts. The external leaf-crown contains 18 elements, the internal 36. The œsophagus is about 0.8 mm. long. The nerve-ring is situated at the level of the cervical groove, or behind it. The cervical papillæ are behind the posterior end of the œsophagus, at about 1.25 mm. from the anterior extremity.

The spicules are 1.1–1.5 mm. long. The accessory piece is shovel-shaped, with a short "handle," and measures 0.09–0.12 mm. in length. The tail of the female is 0.15–0.2 mm. long, straight and sharply pointed. The vulva is situated at 0.375–0.5 mm. from the posterior end. The vagina is 0.4–0.6 mm. long. The eggs measure $0.085-0.1 \times 0.045-0.055$ mm.

6. **Œsophagostomum asperum** Railliet and Henry, 1913.

[Synonym :—*Œsophagostomum (Hysteracrum) asperum* Railliet and Henry, 1913.]

Host :—This species has been recorded from the intestine of goats in various parts of the world (the Panama Canal Zone, China and the Federated Malay States). Bhalerao has recorded it from the Himalayan ibex (*Capra sibirica*) at Muktesar, United Provinces.

The male measures about 11–13 mm. in length and 0.42–0.48 mm. in maximum thickness, the female about 14–17.5 mm. and 0.5–0.6 mm. respectively. The cuticular striations are at intervals of 5–7 μ . The mouth-collar is in the form of a truncate cone and measures 0.06–0.062 mm. in length. It is marked off by a well-defined groove posteriorly. The cephalic inflation of the cuticle is well developed. The cervical groove is well marked ventrally and extends on to the lateral surfaces as far as the lateral lines. It is situated at about 0.32–0.36 mm. from the anterior extremity. The external leaf-crown consists of 12 bluntly rounded elements, the internal leaf-crown of 24 small elements. The buccal capsule is about 0.04–0.044 mm. long and about twice as wide. Its base is at the level of the posterior limit of the mouth-collar. On the inner surface of its wall, at about the posterior third, there is an annular groove. The œsophagus is club-shaped and measures about 0.74–0.88 mm. in length. The cervical papillæ are situated behind it, at a distance of 1–1.5 mm. from the anterior end. The nerve-ring is just behind the cervical groove.

The spicules of the male measure 1.35–1.7 mm. in length. The accessory piece, according to Goodey, is about 0.1 mm. long and is shovel-shaped, but with the handle of the shovel missing or represented by a small, rounded knob.

The tail of the female is 0.14–0.17 mm. long, and bears a pair of papillæ at 0.055–0.06 mm. from the tip. The anus and vulva are rather prominent. The latter is situated at about 0.32–0.39 mm. from the posterior end. The vagina runs forward for a distance of about 0.65–0.87 mm. The eggs measure 0.083–0.085 \times 0.055–0.06 mm.

7. **Œsophagostomum columbianum** (Curtice, 1890) Stossich, 1899. (Fig. 136.)

Synonyms :—*Œsophagostoma columbianum* Curtice, 1890 ; *Hypostomum columbiana* Stewart, 1898 ; [*Œsophagostomum (Proteracrum) columbianum* Railliet and Henry, 1913].

Hosts :—This widely-distributed species occurs in the large intestine of the sheep and goat, and has occasionally been

recorded from cattle. According to Gaiger it is common in sheep and cattle in the Punjab.

The male measures 12–16 mm. in length and 0.23–0.4 mm. in maximum thickness, the female 14–18 mm. and 0.3–0.5 mm. respectively. The anterior end of the worm is frequently curved into a hook. The mouth-collar is in the form of a truncate cone, and its posterior edge is rather prominent. There is no cephalic inflation. The cervical groove extends only as far as the lateral alæ. Lateral alæ extend from the groove throughout almost the whole length of the body. The external leaf-crown contains 20 to 24 elements, the internal

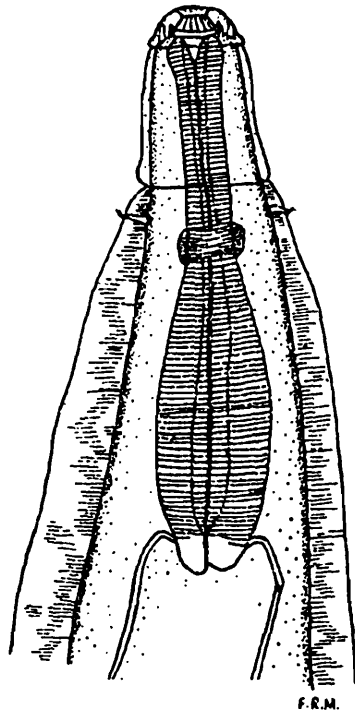

Fig. 136.—*Esophagostomum columbianum*. Anterior end ; dorsal view.
(From Baylis, after Ransom.)

40 to 48. The œsophagus is about 1 mm. long. The cervical papillæ project through the lateral alæ just behind the cervical groove. The nerve-ring is somewhat behind them, but in front of the middle of the œsophagus.

The spicules measure 0.75–0.85 mm. in length, the accessory piece about 0.1 mm. The tail of the female is tapering and 0.3–0.6 mm. long. The vulva, which is slightly prominent, is situated at about 1–1.4 mm. from the posterior extremity. The vagina is less than 0.1 mm. long. The eggs measure 0.065–0.075 × 0.04–0.045 mm.

8. *Œsophagostomum indicum* Maplestone, 1931. (Fig. 137.)

[Synonym :—*Œsophagostomum (Hysteracrum) indicum* Travassos and Vogelsang, 1932.]

Hosts :—This species is recorded from the large intestine of the spotted deer (*Cervus axis*) and red deer (*Cervus elaphus*) in the Zoological Gardens, Calcutta.

The male measures 7·6–9·1 mm. in length (or up to 10·5 mm. in the red deer) and 0·34–0·36 mm. in maximum thickness, the female 9·9–10·4 mm. (or up to 12·2 mm. in the red deer) and 0·38 mm. respectively. The mouth-collar is rather deep and marked off by a groove, and has a diameter of 0·13–0·14 mm.

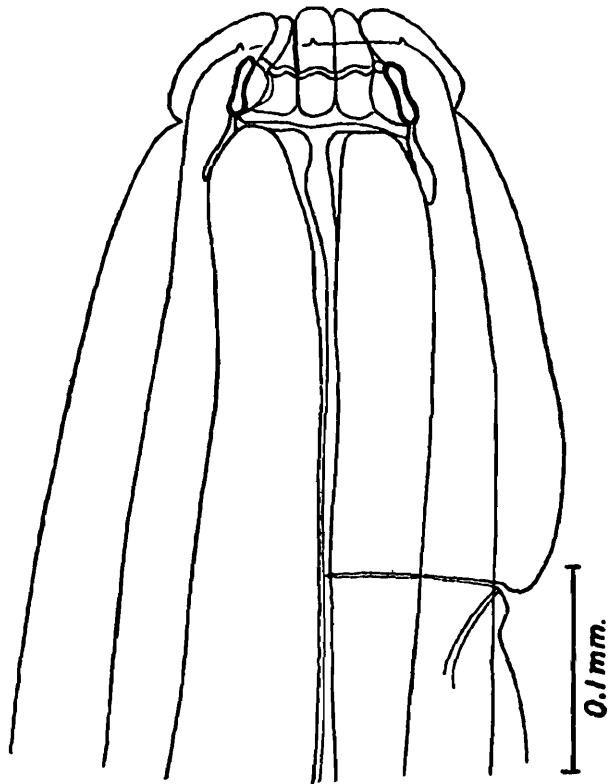

Fig. 137.—*Œsophagostomum indicum*. Anterior end ; lateral view. (After Maplestone.)

There is a cephalic inflation, as in *O. dentatum*. The cervical groove is situated at 0·26–0·28 mm. from the anterior end. The buccal capsule is wider posteriorly than anteriorly, and has a maximum diameter of 0·066–0·072 mm. In frontal optical section there is seen to be a broad, shallow, longitudinal groove on each of the external lateral surfaces of the capsule. Each of the leaf-crowns contains ten broad elements. “The external leaf crown arises from the base of the capsule, from which it sweeps inwards and forwards. The internal leaf crown consists of very short coarse elements, which in optical section appear as a double-contoured wavy line running across

the capsule at its anterior end." The œsophageal funnel has three longitudinal cuticular ridges projecting into its lumen. The œsophagus is about 0.71 mm. long. The cervical papillæ are situated just behind its posterior end.

The spicules measure 1.3–1.36 mm. in length, and the accessory piece, which is of the typical trowel shape, 0.084 mm. The tail of the female is straight and sharply pointed, and is 0.13–0.14 mm. long. The vulva is situated at 0.18 mm. from the anus. The vagina is relatively long. The eggs measure 0.068–0.076 × 0.036–0.042 mm.

9. *Æsophagostomum blanchardi* Railliet and Henry, 1912.
(Figs. 138 & 139.)

[Synonym :—*Æsophagostomum* (*Conoweberia*) *blanchardi* Travassos and Vogelsang, 1932.]

Hosts :—Specimens found on three occasions in the stomach of the hoolock gibbon (*Hylobates hoolock*) in the Zoological Gardens, Calcutta, were referred by Maplestone, with some doubt, to *Æsophagostomum apiostomum* (Willach, 1891). According to Travassos and Vogelsang, who have recently revised the species of *Æsophagostomum* parasitic in Primates, Maplestone's material was probably referable to *O. blanchardi*, a species which was originally recorded from the orang outan (*Simia satyrus*) from Borneo.

The following description is taken mainly from Travassos and Vogelsang.

The male measures 15–17 mm. in length and 0.45 mm. (according to Maplestone 0.614 mm.) in maximum thickness, the female 17–20 mm. and 0.57–0.71 mm. respectively. The cephalic inflation is well developed. The cervical groove is situated at 0.22–0.3 mm. (according to Maplestone, up to 0.376 mm.) from the anterior end. The buccal capsule measures 0.02–0.028 mm. in length, and its greatest diameter, at the posterior end, is 0.056–0.064 mm., or, according to Maplestone, 0.088–0.096 mm. The external leaf-crown normally contains 10 elements, but sometimes more—up to 13 (Travassos and Vogelsang), 14 (Maplestone), or even 16 (Railliet and Henry). The internal leaf-crown contains numerous small elements. The œsophageal funnel is wide. Its walls are slightly incurved and bear three teeth anteriorly. The œsophagus is about 0.7–0.9 mm. long (up to 0.951 mm., according to Maplestone). The cervical papillæ are situated at about 0.42–0.57 mm. from the anterior extremity.

The spicules measure 1.3–1.4 mm. (according to Maplestone 1.56–1.58 mm.) in length. The length of the accessory piece,

according to the latter author, is 0.158–0.16 mm. The tail of the female is conically pointed and 0.18–0.24 mm. long. The vulva is situated at 0.37–0.48 mm. from the posterior end, or, according to Maplestone, at 0.218–0.297 mm. from the

Fig. 138.

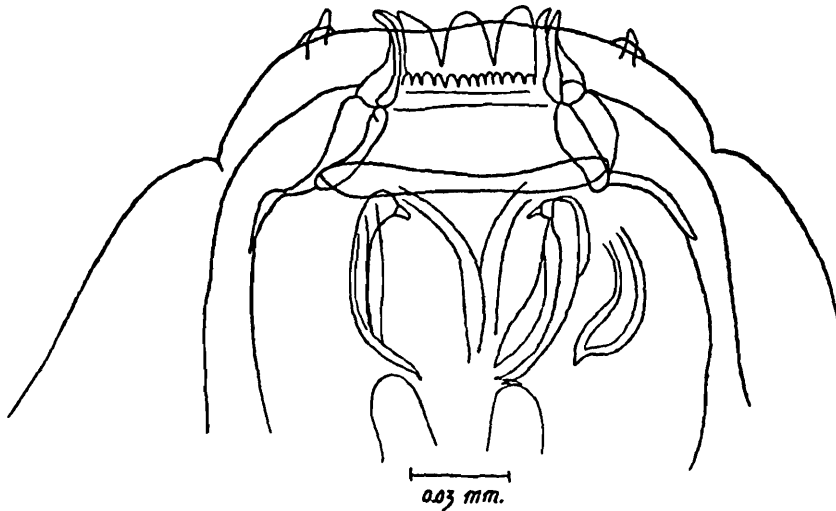

Fig. 139.

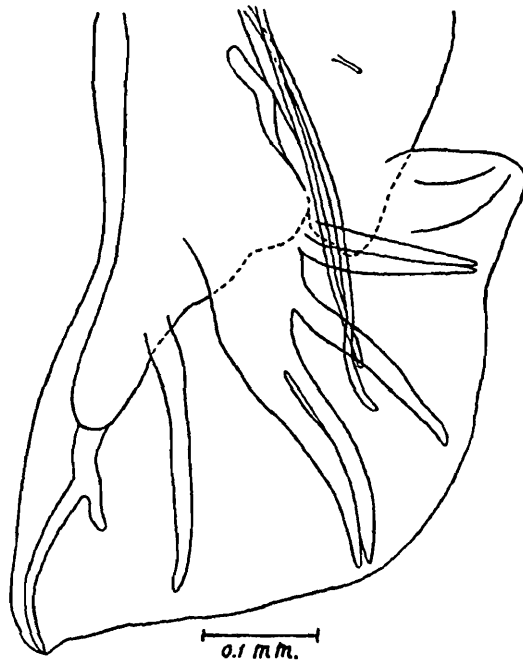

Fig. 138.—*Æsophagostomum blanchardi*. Anterior end. (After Travassos and Vogelsang.)

Fig. 139.—*Æsophagostomum blanchardi*. Bursa of male; lateral view. (After Travassos and Vogelsang.)

anus. The vagina is 0.297–0.396 mm. long (Maplestone). The eggs measure 0.072–0.08 × 0.04–0.044 mm. (Maplestone gives 0.064 × 0.04 mm.).

10. *Œsophagostomum ovatum* (v. Linstow, 1906) Railliet and Henry, 1912.

Synonyms:—*Strongylus ovatus* v. Linstow, in Smidt, 1906; *Œsophagostomum blanchardi* of Maplestone, 1931, nec Railliet and Henry, 1912; *Œsophagostomum (Conoweberia) ovatum* Travassos and Vogelsang, 1932; *Œsophagostomum (Conoweberia) raillieti* Travassos and Vogelsang, 1932.

Hosts:—*Strongylus ovatus* was originally recorded from *Hylobates syndactylus* and *H. agilis* in Sumatra. Maplestone (1931) has recorded, under the name of *Œsophagostomum blanchardi* Railliet and Henry, a species from the stomach of the hoolock gibbon (*Hylobates hoolock*) in the Zoological Gardens, Calcutta. Travassos and Vogelsang (1932) consider that Maplestone's form is not *O. blanchardi*, and regard it as a new species, for which they propose the name *O. raillieti*. They state at the same time, however, that it is possible that it may be *O. ovatum*, an imperfectly-described form of which they have not had the opportunity to examine material, and which they regard as a species of doubtful validity.

The present writer (1926) gave some description of a single male specimen from *Hylobates mülleri* in Sarawak, Borneo, which was provisionally referred to *O. ovatum*. The measurements of this specimen agree so closely with those given by Maplestone for his "*O. blanchardi*" that the writer feels justified in assuming it to be of the same species, and, on the ground of the hosts and geographical distribution, further assuming that Maplestone's species is identical with v. Linstow's.

The dimensions of *O. ovatum*, according to v. Linstow, are:—Male 11.1 mm. in length and 0.53 mm. in thickness; female 8.7–19.3 mm. and 0.43–0.7 mm. respectively. Maplestone gives 15.3 mm. and 0.654 mm. for the male, 19.2 mm. and 0.83 mm. for the female. The writer's male specimen measured about 17 mm. in length and 0.7 mm. in maximum thickness. The cuticular striations, according to v. Linstow and the writer, are at intervals of about 20 μ . The cervical groove is situated, according to Maplestone, at 0.356 mm. in the male, and at 0.396 mm. in the female, from the anterior end. The writer gave 0.45 mm. for the male. The walls of the buccal capsule are somewhat lenticular in optical section. The capsule measures 0.039–0.041 mm. in length (Maplestone) or 0.037 mm. (Baylis); its width is 0.112–0.12 mm. (Maplestone) or 0.14 mm. (Baylis). The external leaf-crown, according to Maplestone, contains 14 elements. The œsophagus measures 0.94 mm. (Baylis) or 1.05–1.1 mm. (Maplestone) in length. The cervical papillæ, according to Maplestone, are situated at 0.536 mm. from the anterior end in the male.

The spicules measure, in an immature male, according to v. Linstow, 1.19 mm. in length; in mature males 1.98 mm. (Maplestone) or about 2 mm. (Baylis). The accessory piece, according to Maplestone, is 0.2 mm. long. The length of the tail in the female, according to the same author, is 0.277 mm., the distance from vulva to anus 0.297 mm., the length of the vagina 0.535 mm., and the dimensions of the eggs 0.068×0.044 mm.

11. *Œsophagostomum tridentatum* Maplestone, 1932. (Figs. 140 & 141.)

Host:—Dusky langur (*Semnopithecus obscurus*) (stomach); Zoological Gardens, Calcutta.

The male measures about 12–14 mm. in length and 0.5–0.6 mm. in maximum thickness, the female about 14–17 mm.

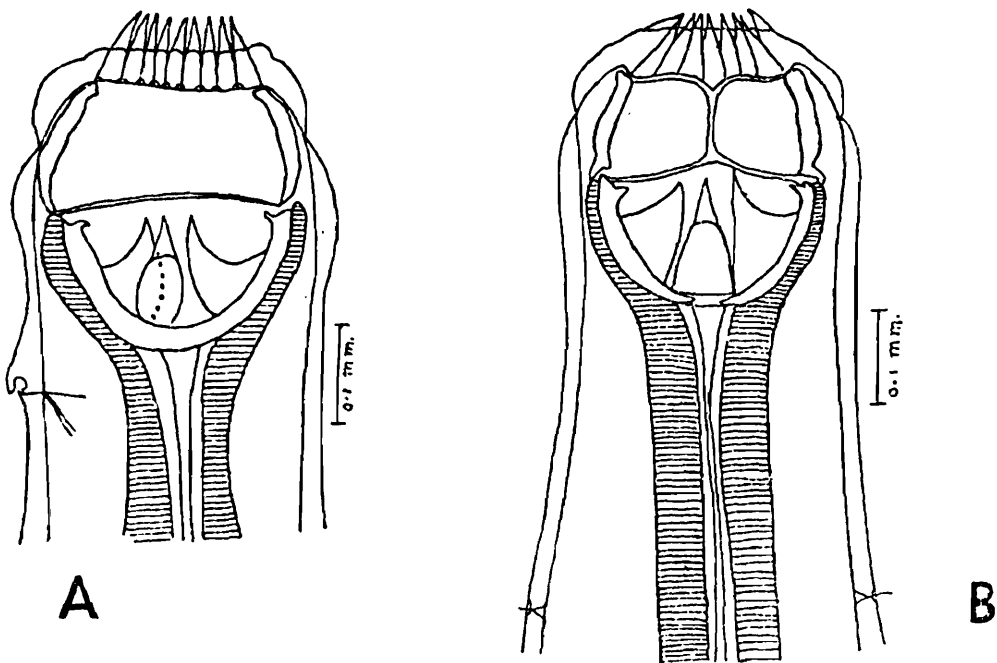

Fig. 140.—*Œsophagostomum tridentatum*. Anterior end. A, lateral view; B, dorsal view. (After Maplestone.)

and 0.65–0.7 mm. respectively. The mouth-collar is somewhat conical. The cervical groove, which is well marked but apparently confined to the ventral surface, is situated at about 0.36–0.49 mm. from the anterior end. The external leaf-crown consists of 20 broad, pointed elements which project beyond the mouth-collar. “There is no internal leaf-crown, but on each side of the base of the leaves of the external leaf-crown there is a small knob-like thickening which probably represents a rudimentary leaf-crown.” The buccal capsule measures about 0.1–0.16 mm. in length and 0.2–0.3 mm.

in width. "Its dorsal wall is slightly shorter than the rest of the capsule and the duct of the dorsal gland is marked by two longitudinal ridges internally and by a slight groove externally." The œsophageal funnel forms a wide, cup-shaped cavity, as wide anteriorly as the base of the buccal capsule, and measuring about 0.12–0.16 mm. in length. From its walls, near the base, there arise three large, anteriorly-directed teeth with broad bases and sharp points. One of these teeth is dorsal and two subventral. The œsophagus is about

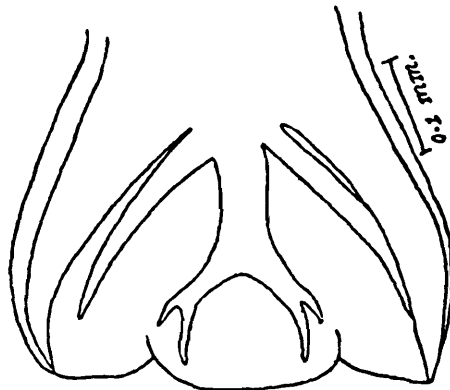

Fig. 141.—*Esophagostomum tridentatum*. Bursa of male; dorsal view. (After Maplestone.)

1 mm. long. The cervical papillæ are situated at about 0.54–0.61 mm. from the anterior extremity.

The arrangement of the rays of the bursa in the male is typical. Prebursal papillæ are present. The spicules measure 1.6 mm. and the accessory piece 0.175–0.18 mm. in length.

The tail of the female is about 0.16–0.2 mm. long. The vulva is situated at about 0.16–0.2 mm. from the anus. The vagina measures about 0.3–0.34 mm. in length. The eggs measure 0.072–0.08 × 0.04–0.044 mm.

12. *Esophagostomum traguli* (Maplestone, 1932).

Synonym :—*Esophagostomoides traguli* Maplestone, 1932 (not *Bourgelatioides traguli* Chandler, 1931).

Host :—Javan mouse-deer (*Tragulus javanicus*) (intestine); Zoological Gardens, Calcutta.

In this very small species the male measures 2.9 mm. in length, the female 3 mm. The maximum thickness in both sexes is 0.218 mm. A mouth-collar is not apparent. The external leaf-crown consists of eight (? ten) coarse, rounded elements arising from the anterior border of the buccal capsule and curving outwards. According to Maplestone "there is no ventral cervical groove, but there is a distinct cephalic inflation which is marked posteriorly by a projecting ridge

followed by a groove in the cuticle which completely encircles the body." The buccal capsule is small and cylindrical. It measures 0.006 mm. in length and 0.004 mm. in width. The œsophagus is nearly cylindrical for its anterior two-thirds, but has a large bulb-like swelling posteriorly. Its length (in the female) is 0.164 mm. The nerve-ring is situated just in front of the posterior swelling. The excretory pore and cervical papillæ were not seen.

The bursa of the male is typical. The spicules are tapering, pointed and alate, and measure 0.872 mm. in length. An accessory piece is present.

The tail of the female is 0.084 mm. long, narrows suddenly at about its middle and ends in a sharp point. The vulva is situated at 0.04 mm. from the anus. The muscular vagina runs forward for a distance of 0.396 mm., and has a constriction at about its middle. It divides into two opposed, muscular ovejectors, from the ends of which the uterine branches arise. The posterior of these turns forward almost immediately to run parallel to the anterior branch. The eggs measure 0.052–0.056 × 0.03–0.036 mm.

2. Genus **BOSICOLA** Sandground, 1929.

Synonym :—*Bourgelatioides* Chandler, 1931.

Mouth-collar circular in optical section. Cephalic inflation well developed, with a shallow annular constriction behind its middle, and limited behind by a cervical groove which runs completely round the neck and extends further back dorsally and ventrally than laterally, forming dorsal and ventral cuticular flaps. Lateral alæ well developed, beginning at the cervical groove and extending throughout almost the whole length of the body. Buccal capsule shallow, more or less cylindrical. External leaf-crown absent. Internal leaf-crown represented by a ring of small denticles at the anterior border of the buccal capsule. In other characters the genus closely resembles *Æsophagostomum*. Adults parasitic in the intestine of ruminants.

Genotype :—*Bosicola radiatus* (Rudolphi, 1803).

Key to Species.

- | | |
|--|---------------------------|
| Spicules of male with convoluted terminal filaments | <i>traguli</i> , p. 307. |
| Spicules of male without terminal filaments. | 1. |
| 1. Internal leaf-crown contains about 40 elements ; œsophagus about 1 mm. long | <i>radiatus</i> , p. 306. |
| Internal leaf-crown contains at least 50 elements ; œsophagus about 0.6–0.8 mm. long | <i>curvatus</i> , p. 307. |

1. *Bosicola radiatus* (Rud., 1803). (Fig. 142.)

Synonyms :—*Strongylus radiatus* Rudolphi, 1803; *Strongylus inflatus* Schneider, 1866, nec Molin, 1861; *Strongylus dilatatus* Railliet, 1884; *Æsophagostomum inflatum* Railliet, 1885; *Ankylostoma radiatum* Blanchard, 1888; *Æsophagostomum dilatatum* Railliet, 1896; *Æsophagostomum radiatum* Railliet, 1898; *Æsophagostomum vesiculosum* v. Rátz, 1898; *Æsophagostomum bovis* Schnyder, 1906; *Æsophagostomum biramosum* Cuillé, Marotel and Panisset, 1911; *Æsophagostomum (Proteracrum) radiatum* Railliet and Henry, 1913; *Bosicola tricollaris* Sandground, 1929; *Æsophagostomum (Bosicola) radiatum* Travassos and Vogelsang, 1932.

Hosts :—This species is a widely-distributed parasite of the large intestine of cattle. It is mentioned by Gaiger as fairly

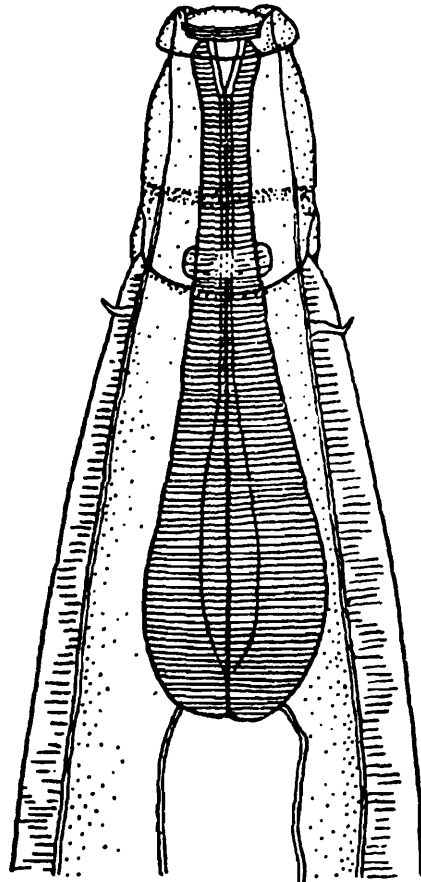

Fig. 142.—*Bosicola radiatus*. Anterior end; dorso-ventral view. (After Ransom.)

common in cattle in the Punjab, and has also been recorded from the buffalo (*Bos bubalus*) by Lane (locality, Darjeeling) and by Baylis and Daubney, and from a "hybrid bison" (*Bos frontalis* × *B. taurus*) in the Zoological Gardens, Calcutta, by Maplestone.

The male measures 14–17 mm. in length and 0.3–0.4 mm. in maximum thickness, the female 16–22 mm. and 0.3–0.4 mm. respectively. The buccal capsule is slightly wider in front than behind. The internal leaf-crown contains 38 to 40 elements.

The œsophageal funnel is well developed and measures about 0.075 mm. in length. The œsophagus is about 1 mm. long. The cervical papillæ are situated towards the middle of the œsophagus, a little behind the posterior limit of the cephalic inflation.

The spicules measure 0.7–0.8 mm. in length, the accessory piece about 0.1–0.115 mm. The posterior end of the female is slightly curved ventrally. The tail is 0.3–0.4 mm. long. The vulva is rather prominent, and is situated at about 1 mm. from the posterior end. The vagina is about 0.1 mm. long. The eggs measure 0.075–0.085 × 0.04–0.045 mm.

2. *Bosicola curvatus* (Maplestone, 1931).

Synonyms :—*Æsophagostomum curvatum* Maplestone, 1931; *Æsophagostomum (Bosicola) curvatum* Travassos and Vogelsang, 1932.

Host :—Spotted deer (*Cervus axis*) (large intestine); Zoological Gardens, Calcutta.

The male measures 8.4–9.6 mm. in length and 0.29–0.32 mm. in maximum thickness, the female 12.5–14.8 mm. and 0.36–0.42 mm. respectively. The anterior end is bent into a hook. “There is a well-marked mouth collar in the form of a ring with rounded edges, which curves forwards laterally.” The diameter of the mouth-collar (in the male) is 0.075 mm. The cephalic inflation is similar to that of *B. radiatus*. The cervical groove is situated at 0.21–0.22 mm. from the anterior end. The buccal capsule is cylindrical and measures 0.028–0.032 mm. in diameter. The internal leaf-crown contains at least 50 elements. The œsophageal funnel is 0.044 mm. deep, and “is marked off from the rest of the œsophagus by a transverse line, and its chitinous lining is furnished with three sharp longitudinal ridges which might almost be regarded as teeth.” The œsophagus is 0.57–0.61 mm. long in the male, 0.65–0.79 mm. in the female. The cervical papillæ are situated at 0.28 mm. from the anterior end.

The spicules measure 0.49–0.59 mm. in length, and their tips are curved ventrally. The accessory piece is “in the form of a deep trough in which the spicules lie.” The tail of the female is straight and slender, and measures 0.22–0.26 mm. in length. The vulva is situated at 0.57–0.75 mm. from the anus. The eggs measure 0.072–0.076 × 0.04 mm.

3. *Bosicola traguli* (Chandler, 1931).

Synonym :—*Bourgelatioides traguli* Chandler, 1931.

Host :—Javan mouse-deer (*Tragulus javanicus*) (small intestine); Zoological Gardens, Calcutta.

The male measures 11.3 mm. in length and 0.42 mm. in thickness, the female 11.5 mm. and 0.46 mm. respectively. The cuticle shows fine striations, which are more distinct in the female than in the male. The cephalic inflation is similar to that of *B. radiatus*. "The groove and overlying flap which separate the head from the rest of the body are about 200 μ from anterior end of body." The buccal capsule is shallow and cylindrical. The internal leaf-crown contains 20 to 25 elements. The head, at the level of the posterior end of the capsule, has a diameter of about 0.067 mm. The œsophagus is club-shaped and measures about 0.55 mm. in length.

The spicules have striated alæ and taper to fine points, each bearing a long, convoluted terminal filament. They measure, excluding the filaments, 0.655 mm. in length. The tail of the female is sharply pointed and 0.2 mm. long. The vulva is situated at about 0.25 mm. from the anus, and has prominent lips. The eggs measure about 0.077×0.04 mm.

3. Genus **CHABERTIA** Railliet and Henry, 1909.

Anterior end obliquely truncate, so that the mouth faces antero-ventrally. Ventral cervical groove faint. A trace only of a cephalic vesicle present ventrally. Buccal capsule large, subglobular, without teeth. Much-reduced external and internal leaf-crowns present, just behind its anterior margin. Spicules long, tubular and slender. An accessory piece present. Adult worms parasitic in the intestine of ruminants.

Genotype:—*Chabertia ovina* (Gmelin, 1790).

1. **Chabertia ovina** (Gmelin, 1790) Railliet and Henry, 1909.

Synonyms:—*Strongylus ovinus* Gmelin, 1790*; *Strongylus contortus* Rudolphi, 1802 (part); *Strongylus hypostomus* Rudolphi, 1819; *Sclerostoma hypostomum* Dujardin, 1845 (part); *Dochmius hypostomus* Diesing, 1851 (part); *Sclerostomum hypostomum* Leuckart, 1867; *Sclerostomum ovinum* Stossich, 1899.

Hosts:—This species occurs in the large intestine of the ox, sheep, goat and various other ruminants, and is of cosmopolitan distribution. Bhalerao (1935, *b*) records it from cattle (*Bos indicus*) and sheep at Muktesar, United Provinces, and in the Punjab.

The male measures 13–16 mm. in length and about 0.35–0.5 mm. in maximum thickness, the female 15–25 mm. and

* Fabricius, 1788, has been quoted by Railliet as the author of this name, but the reference is to Fabricius, in Müller, 1788, Zool. Dan. ii, p. 8. On p. 3 (not p. 8) of Müller it is stated that Fabricius recently found a *Strongylus* "in intestinis ovium," but apparently he did not name it.

about 0.5–0.65 mm. respectively. The buccal capsule is large and subglobular anteriorly, but somewhat narrowed and truncate posteriorly. Its length is about 0.54 mm. The two leaf-crowns consist of numerous small, pointed denticles. The œsophagus is club-shaped and measures 1.2–1.4 mm. in length. The nerve-ring is situated at about the anterior third of the œsophagus, and the excretory pore just behind the cervical groove.

The dorsal lobe of the bursa is slightly longer than the lateral lobes. The tips of the antero-lateral and externo-dorsal rays are some distance from the edge of the bursa, the other rays reaching the edge. The ventral rays are close together, as are also the medio-lateral and postero-lateral rays. The antero-lateral ray diverges from the medio-lateral, and is stouter than the other lateral rays. The branches of the dorsal ray are bidigitate, the inner termination only reaching the edge of the bursa. Large prebursal papillæ are present. The spicules measure 1.3–1.7 mm. in length and are provided with alæ. The accessory piece is 0.08–0.1 mm. long.

The tail of the female measures 0.2–0.23 mm. in length. It diminishes rapidly in thickness from the anus to about its middle, and then tapers more gradually to a sharp point, which is curved dorsally. The vulva is situated at about 0.37–0.5 mm. from the posterior end. The vagina is about 0.15 mm. long. The combined length of the muscular portions of the ovejectors is 0.2 mm. or more. The eggs measure 0.09–0.1 × 0.05 mm. Their contents are segmenting when they are laid.

Subfamily STEPHANURINÆ Railliet,
Henry and Bauche, 1919.

Buccal capsule well developed, cup-shaped, with a leaf-crown at its anterior margin. Bursa of male subterminal and poorly developed, with stunted rays. Worms parasitic in the ureters or in the abdominal viscera of Ungulates.

1. Genus **STEPHANURUS** Diesing, 1839.

Worms of relatively stout form. Mouth circular, provided with an external leaf-crown of small elements. Cuticle surrounding the mouth reflected externally to form six thickenings or "epaulettes," two median and four submedian. Buccal capsule cup-shaped, with thick walls. At its base there are six teeth which may be bicuspid or tricuspoid. Rays of bursa short and stout. Dorsal ray divides into two branches

which are bifurcate or trifurcate at their tips. Lateral rays closely applied to each other; the postero-lateral ray thicker than the other two. Spicules equal or subequal. An accessory piece present. Tail of female short, abruptly attenuated behind the anus and bearing a pair of globular lateral cuticular processes. Vulva close to anus. Uterine branches parallel. The intestine is considerably longer than the body, and is therefore convoluted.

Genotype :—*Stephanurus dentatus* Diesing, 1839.

1. *Stephanurus dentatus* Diesing, 1839. (Fig. 143.)

Synonyms :—*Sclerostoma pinguicola* Verrill, 1870; *Strongylus dentatus* Dean, 1874, nec Rudolphi, 1803; *Stephanurus nattereri* Cobbold, 1879; *Strongylus (Sclerostoma) pinguicola* Magalhães, 1894; *Sclerostomum renium* Drabble, 1922; *Stephanurus morai* Almeida, 1928; ? *Sclerostoma dentatum* of Leidy, 1856, nec Rudolphi, 1809.

Hosts :—This worm occurs as an adult in the ureters of the pig. Immature specimens are found in the perirenal fat, in the liver or other abdominal viscera, and occasionally

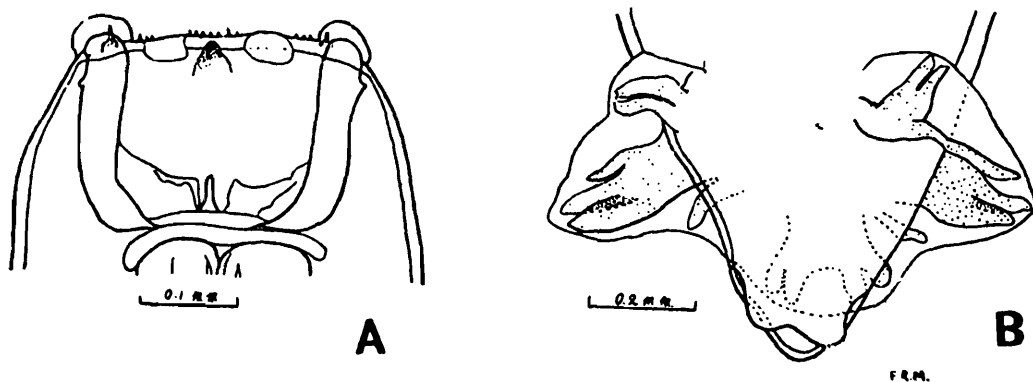

Fig. 143.—*Stephanurus dentatus*. A, anterior end; B, posterior end of male, ventral view. (From Baylis, after Daubney.)

in the lungs. The ox and the donkey have also been recorded as hosts of this species. The parasite has a wide geographical distribution, but although it has been recorded from Annam, Java and Sumatra, the writer has been unable to find any definite Indian records. Baylis and Daubney (1923, *b*) record specimens in the collection of the Zoological Survey of India, but these may or may not have been of Indian origin. Daubney (1923) mentions specimens in the British Museum (Natural History) from East Africa and India, but these localities are incorrect, the material in question having come from the Gold Coast and the West Indies respectively.

The following description is taken mainly from that given by Daubney.

The male measures 20–30 mm. in length and up to 1.2 mm. in maximum thickness, the female 25–45 mm. and up to

1.8 mm. respectively. The anterior end of the body is sometimes curved ventrally. The buccal capsule measures about 0.18 mm. in length and the same in maximum width. At its base there are usually six teeth, which are variable in shape. The leaf-crown contains about 50 small, pointed elements. The œsophagus is shaped like an Indian club. Its length (in the female) is about 1.6 mm. The nerve-ring is situated at about 0.5 mm. from the anterior end, and the excretory pore about 0.5–0.6 mm. behind the nerve-ring.

The spicules have transversely striated alæ and are slightly swollen at the tips. They vary in length from about 0.66 to 1 mm., and may be equal or unequal. When the latter is the case, the left spicule is the longer. The accessory piece is flattened and heart-shaped, and measures about 0.075 mm. in length.

In the female the body is bent ventrally, almost at a right angle, behind the vulva. The tail is about 0.59 mm. long, and is suddenly constricted in diameter a little behind the anus. At about the level of the anus there is a pair of lateral processes of globular form. The vulva is situated at about 1.36 mm. from the anus. The vagina is very short, and leads into paired uterine branches which are opposed at first. The posterior branch, however, turns forward almost at once to run parallel with the other. The eggs measure $0.09\text{--}0.1 \times 0.056\text{--}0.065$ mm.

The life-history of *Stephanurus* has been studied recently by several observers, and may be summarized as follows. The eggs reach the exterior with the urine of the host, and hatch after one or two days. The larvæ reach the infective stage after a further four or five days, under favourable conditions of temperature and moisture. They are capable of remaining alive in the open for about five months, but cannot withstand drying. Infection may take place either through the swallowing of infective larvæ with food or water, or through larvæ penetrating the skin. The latter process appears to be facilitated if there are wounds in the skin through which the larvæ can enter, and there is a difference of opinion as to whether the larvæ are able to penetrate the uninjured skin of the pig. By whatever route they enter the body, the larvæ appear to undergo their third moult soon afterwards, and then the majority of them migrate (probably by way of the portal system) to the liver, though some may be found in other organs and tissues. In the liver they remain for several months, and undergo the fourth moult. Finally they migrate, apparently by direct penetration through the tissues, to the perirenal fat and to the ureters. In the last situation they reach maturity.

Subfamily SYNGAMINÆ Baylis and
Daubney, 1926.

Buccal capsule well developed, subglobular, without leaf-crowns at its anterior margin, but with teeth at its base. Eggs operculate. Parasites of the respiratory tract of birds and mammals.

1. Genus **SYNGAMUS** v. Siebold, 1836.

Sexes joined permanently *in copula*. Buccal capsule large, furnished at its base with a variable number of teeth. Bursa of male small and thick-walled, its rays short and stout. Spicules small, in some species extremely small and difficult to detect. Vulva in anterior third of body. Adult worms parasitic in the trachea or bronchi of birds and mammals.

Genotype :—*Syngamus trachea* (Montagu, 1811).

Key to Species.

Parasite of birds		<i>trachea</i> , p. 312.
Parasite of cattle and buffalo	<i>laryngeus</i> , p. 315.
Parasite of elephant		<i>indicus</i> , p. 315.

1. **Syngamus trachea** (Montagu, 1811) Chapin, 1925. (Figs. 144 & 145.)

Synonyms :—*Fasciola trachea* Montagu, 1811 ; *Syngamus trachealis* v. Siebold, 1836 ; *Strongylus trachealis* Nathusius, 1837 ; *Strongylus pictus* Creplin, 1849 ; *Strongylus meleagris gallopavonis* Diesing, 1851 ; *Sclerostoma syngamus* Diesing, 1851 ; *Sclerostoma tracheale* Diesing, 1851 ; *Syngamus primitivus* Molin, 1860 ; *Strongylus primitivus* Hutyra and Marek, 1910.

Hosts :—This species has been recorded from the fowl, turkey, goose, pheasant and a considerable number of other birds belonging to various orders. It is particularly prevalent in young birds, and frequently produces in them the condition known as “gapes,” which may result in their death from suffocation. The adult worms occur in the trachea and bronchi of their hosts, immature worms in the lungs and air-sacs. The parasite is widely distributed throughout the world, but the only record from the Indian region appears to be from the fowl at Colombo, Ceylon (v. Linstow).

The male measures 2–6 mm. in length and 0.2–0.4 mm. in maximum thickness, the female 5–40 mm. and 0.35–1.4 mm. respectively. The mouth is surrounded by an inflated cuticular ring whose outer margin is incised to form six festoons. The buccal capsule is hemispherical and has from six to ten

Fig. 144.

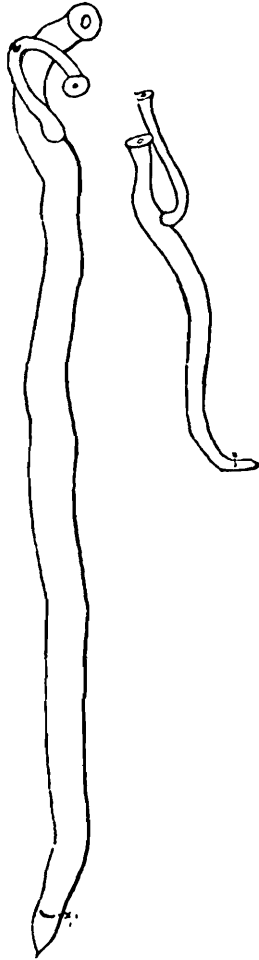
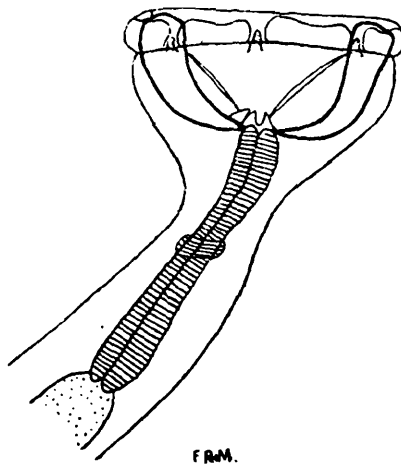

Fig. 145.



FROM

Fig. 144.—*Syngamus trachea*. Outlines of two pairs of worms. On the right, female immature; on the left, female gravid. (From Baylis, after Chapin.)

Fig. 145.—*Syngamus trachea*. Anterior end. (From Baylis, after Yorke and Maplestone.)

teeth at its base. Chapin describes the typical arrangement of the teeth as follows:—A large median dorsal tooth which may or may not show two cusps; on either side of this a very small subdorsal tooth; a pair of large, unicuspid, lateral teeth and a pair of similar subventral teeth; and a ventral tooth which is the smallest of all. This last is occasionally divided to form a pair of teeth. The œsophagus occupies about $1/10$ of the total length in the male, $1/25$ to $1/18$ in the female.

The branches of the dorsal ray of the bursa are typically tridigitate, but their mode of branching is variable and they are sometimes asymmetrical. The spicules are delicate and measure 0.057–0.082 mm. in length.

The tail of the female is conical and ends in a pointed process. The vulva varies in relative position according to the age and maturity of the worm. In immature specimens it is situated at about the anterior quarter of the body; in gravid individuals at about the anterior sixth, owing to the disproportionate growth of the posterior region. The coils of the uterine and ovarian tubes, in the gravid female, lie almost entirely behind the vulva, and extend almost to the posterior end of the body. The eggs are ellipsoidal and are provided with an operculum at each end of the shell. They measure 0.078–0.1 × 0.043–0.05 mm. Their contents are segmenting at the time of oviposition. The second larval stage may be reached before hatching occurs.

The life-history of *S. trachea* is briefly as follows. The eggs, laid by the female while still *in copula*, pass out under the margin of the bursa of the male, and enter the lumen of the trachea of the host. Thence they are coughed up into the mouth and swallowed, and eventually reach the exterior with the droppings. In the open they hatch within a fortnight or longer, according to climatic conditions. The first moult may take place before hatching, and the second-stage larva appears to be infective. When such larvæ are swallowed by a suitable host, they migrate to the lungs, where they develop to the fourth stage, at which pairing takes place. They then migrate to the larger air-passages, and within ten to fourteen days after reaching the trachea they attain maturity.

Although the worm can complete its life-history without the aid of an intermediate host, certain earthworms, snails and slugs have been found to act as reservoirs for the larvæ, and birds can acquire infection by swallowing these animals.

2. *Syngamus laryngeus* Railliet, 1899.

Synonyms :—*Syngamus laryncheus* Smit, 1922 ; *Syngamus laryncheus minor* Smit, 1922 ; *Syngamus major* Smit, 1922.

Hosts :—This species was originally recorded from the larynx of the ox in Annam. In India it has been recorded from cattle (*Bos indicus*) and buffalo (*Bos bubalus*) in the Kumaon and Garhwal hills and at Bareilly by Sheather and Shilston, and by these authors and by Ware from the same hosts at Muktesar. It also occurs in South America, the Philippines and other parts of the world. It has been recorded once, somewhat doubtfully, from man in Brazil.

The male measures 2.6–5 mm. in length and 0.34–0.45 mm. in maximum thickness, the female 7–20 mm. and 0.45–0.675 mm. respectively. The cuticular striations are at intervals of about 5 μ . The buccal capsule has a diameter of 0.27–0.47 mm. At its base there are eight teeth of approximately equal size, from each of which a longitudinal rib-like thickening runs forward on the inside of the capsule. Only six of these ribs reach the anterior margin, and these correspond in position with the six cephalic papillæ. The two shorter ribs are in the dorsal and ventral lines. The œsophagus measures about 0.66–1.3 mm. in length. The nerve-ring is situated a little in front of its middle, and the cervical papillæ at 0.6–0.85 mm. from the anterior extremity.

The dorsal rays of the bursa are paired, stumpy and apparently undivided. The spicules are very small and difficult to observe. They measure 0.024–0.03 mm. in length.

The tail of the female is about 0.15–0.25 mm. long, and tapers to a blunt point. The vulva is situated at about the anterior quarter of the body. The coils of the uterine and ovarian tubes extend back only a little beyond the middle of the body, and forward to almost the same distance in front of the vulva. The eggs measure about 0.078–0.085 \times 0.044–0.047 mm.

3. *Syngamus indicus* Mönnig, 1932.

Host :—Indian elephant. Originally recorded from the pharynx of a recently-imported circus elephant in South Africa, this parasite has also been recorded by Bhalerao (1935, *a*) from the larynx and an "œdematous swelling under the neck" of an elephant in the Andaman Islands.

Mönnig (1932) had only a single pair of specimens at his disposal. Bhalerao had a considerable number of specimens, but these were smaller than Mönnig's, and, as the majority of them were not *in copula*, it seems probable that they were not all mature. The differences between the two authors'

accounts are mainly in measurements, and do not seem sufficient to suggest that they were dealing with different species. Their more important points are therefore combined in the following description.

The male measures, according to Bhalerao, 3.75–6.5 mm. in length and 0.31–0.44 mm. in maximum thickness, or, according to Mönnig, 8.5 mm. and 0.59 mm. respectively. The female, according to Bhalerao, is 8.6–18.5 mm. long and 0.335–0.64 mm. thick, while Mönnig gives these measurements as 30 mm. and 0.91 mm. There is no distinct mouth-collar. The cuticular striations are indistinct, and are at intervals varying between 8μ and 45μ . The buccal capsule is subglobular and thick-walled. It measures 0.235–0.4 mm. in length and 0.23–0.44 mm. in outside diameter. Its walls bear internally six longitudinal ridges, each of which corresponds with one of the cephalic papillæ. At the base of the capsule there are eight teeth, 0.083–0.14 mm. in height. Six of these correspond in position with the longitudinal ridges, while two are dorsal and ventral respectively. The œsophagus measures about 0.9–1.9 mm. in length and 0.18–0.44 mm. in maximum thickness. The cervical papillæ, which are short and stout, are situated at about 0.68–1.83 mm. from the anterior extremity, the nerve-ring at 0.66–1.28 mm., and the excretory pore at 0.58–1.61 mm.

The ventral rays of the bursa of the male are stout and closely apposed, and end in narrow points. The anterolateral and medio-lateral rays arise from a common stem and are close together, sometimes ending bluntly, sometimes in narrow points. The postero-lateral rays originate separately from the other lateral rays, and diverge from them. Their bases are sometimes narrowed. The externo-dorsal rays and the two separate dorsal rays all arise independently. The former are sometimes more slender than the other rays, but sometimes stouter than the dorsal rays. The latter end rather abruptly and have a number of small, irregular terminal digitations. The spicules, according to Bhalerao, are 0.06–0.075 mm. long. They were not seen by Mönnig.

The tail of the female tapers rapidly and ends in a point which is curved ventrally. It varies in length between about 0.17 mm. and 0.34 mm. The vulva is situated at 4.4–9 mm. from the anterior end of the body. The eggs measure 0.088–0.105 × 0.046–0.056 mm. Their shells are thickened at the poles, and according to Bhalerao their contents do not proceed beyond the first cleavage *in utero*.

13. Family ANCYLOSTOMIDÆ (Looss, 1905) Lane, 1917.

Buccal capsule relatively well developed, more or less funnel-shaped (probably representing, in most genera, a buccal capsule and œsophageal funnel combined), and bearing ventral teeth or cutting-plates on its anterior margin. Accessory branches of dorsal ray of bursa much reduced.

Subfamily ANCYLOSTOMINÆ (Looss, 1905) Stephens, 1916.

Anterior margin of buccal capsule armed ventrally with from one to four pairs of teeth.

Key to Genera.

Buccal capsule and œsophageal funnel distinct, the former shallow, the latter deep and containing one or two pairs of lancets.	AGRIOSTOMUM, p. 324.
Buccal capsule and œsophageal funnel not distinct	1.
1. Buccal capsule small and incompletely chitinized	GALONCUS, p. 323.
Buccal capsule large and completely chitinized	ANCYLOSTOMA, p. 317.

1. Genus **ANCYLOSTOMA*** (Dubini, 1843) Creplin, 1845.

Synonym :—*Diploodon* Molin, 1861.

Anterior end bent dorsally. Mouth-opening guarded by one to three pairs of ventral teeth. Buccal capsule deep, infundibular, provided internally with a pair of triangular dorsal teeth. Dorsal gutter traverses the dorsal wall of the capsule and opens into a deep notch on its anterior margin. Bursa with a small dorsal lobe. Externo-dorsal rays arise high up on the median stem of the dorsal ray. The latter is cleft for about one-third of its length. The terminations of its main branches appear tridigitate, *i. e.* there are two very short accessory branches close to the tip of each. Spicules not barbed. An accessory piece present. Vulva behind the

* This spelling of the generic name having been adopted by the International Commission on Zoological Nomenclature, it is not thought necessary to give the numerous variants of it in the synonymy. Many of them will be found in the synonymies of the individual species.

middle of the body. Uterine branches opposed. Adult worms parasitic in the intestine of mammals.

Genotype :—*Ancylostoma duodenale* (Dubini, 1843).

Key to Species.

Ventral teeth of buccal capsule not described ; spicules of male about 0·06 mm. long . .	<i>minimum</i> , p. 321.
Ventral teeth of buccal capsule three pairs	1.
Ventral teeth of buccal capsule two pairs	2.
1. Innermost pair of ventral teeth almost as large as the others ; spicules of male about 2 mm. long	<i>caninum</i> , p. 320.
Innermost pair of ventral teeth rudimentary ; spicules of male about 0·9 mm. long	<i>duodenale</i> , p. 318.
2. Inner pair of ventral teeth well developed ; spicules of male about 3 mm. long	<i>malayanum</i> , p. 322.
Inner pair of ventral teeth rudimentary ; spicules of male about 0·8 mm. long	<i>braziliense</i> , p. 321.

1. *Ancylostoma duodenale* (Dubini, 1843) Creplin, 1845.
(Fig. 146, A.)

Synonyms :—*Agchylostoma duodenale* Dubini, 1843 ; *Anchylostomum duodenale* Diesing, 1851 ; *Ancylostomum duodenale* v. Siebold, 1852 ; *Agchylostomum duodenale* Diesing, 1861 ; *Dochmius anchylostomum* Molin, 1861 ; *Sclerostoma duodenale* Cobbold, 1864 ; *Strongylus duodenalis* Schneider, 1866 ; *Dochmius duodenalis* Leuckart, 1867 ; *Ankylostomum duodenale* Bugnion, 1880 ; *Uncinaria duodenalis* Railliet, 1885 ; *Ankylostoma duodenale* Lutz, 1885 ; *Ankylostoma duodenojejunale* Leichtenstern, 1886 ; *Dochmius duodenalis hominis* Poeppel, 1897 ; *Ankylostoma hominis* Leichtenstern, 1898 ; *Uncinaria hominis* Ashford, King and Gutierrez, 1904 ; *Ancylostoma (Ancylostoma) duodenale* Lane, 1916.

Hosts :—This species is very widely distributed in tropical and subtropical countries, and is one of the common “hook-worms” of man. It has, however, also been recorded from the chimpanzee, gorilla, gibbon (*Hylobates lar*), pig and other animals. It is common in man throughout the Indian region, where it has also been recorded from the tiger (Lane, 1917, *c* (Darjeeling district) ; Baylis and Daubney, 1922, 1923, *b*) and from the fishing cat (*Felis viverrina*) (Baylis and Daubney, 1922). Thapar (1929) has recorded “*A. duodenale*” from pariah dogs at Lucknow, but the determination of the species seems questionable.

The measurements in the following description are largely taken from Lane (1916).

The male measures 8–11 mm. in length and 0·4–0·5 mm. in maximum thickness, the female 10–13 mm. and 0·48–0·6 mm. respectively. The cuticular striations are at intervals of 8–11 μ . The buccal capsule measures 0·185–0·225 mm. in length. The ventral teeth consist of two large pairs and a rudimentary inner pair. The œsophagus is 1·1–1·3 mm. long.

The nerve-ring is situated at 0.675–0.72 mm., the excretory pore at 0.8–0.87 mm., and the cervical papillæ at 0.8–1 mm., from the anterior extremity.

The medio-lateral and postero-lateral rays of the bursa are fairly widely separated. The spicules measure about 2 mm. in length, the accessory piece 0.1–0.15 mm.

The tail of the female is 0.13–0.16 mm. long. The vulva is situated at about the posterior third of the body. The eggs measure 0.06–0.065 × 0.03–0.04 mm.

Specimens occurring in the tiger have been found both by Lane and by Baylis and Daubney to be below the average size. This may possibly be an indication that the tiger is a host to which the worm is poorly adapted.

The life-history of this and of other species of hookworms is briefly as follows. The eggs, when laid, are in the early stages of segmentation. In this condition they are passed out with the host's fæces, and in about two days, if the temperature and other conditions are suitable, the

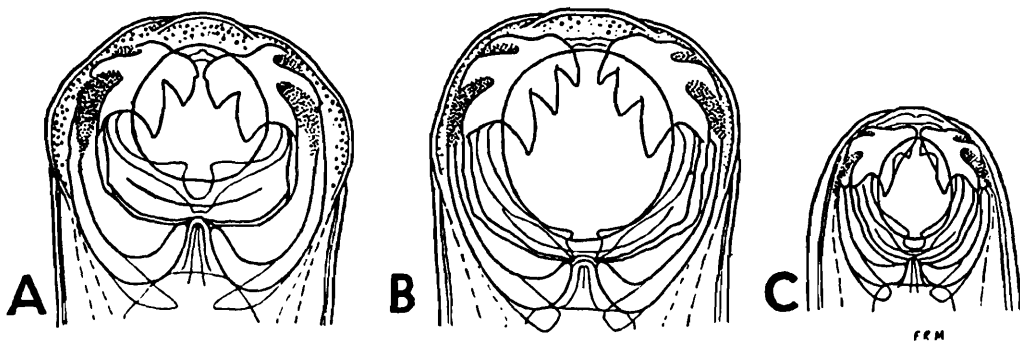

Fig. 146.—*Ancylostoma*. Dorsal views of the mouth of (A) *A. duodenale*; (B) *A. caninum*; (C) *A. braziliense*. (From Baylis, after Looss.)

embryos develop and hatch. They now grow rapidly and moult twice, but after the second moult the cuticle is retained as a protective sheath. This stage is reached in about five days or a week, and the larvæ are now infective. On coming into contact with the skin of a suitable host, or being taken into the mouth, they actively penetrate the skin or the mucous membrane and migrate through the tissues until they find their way into lymphatic vessels or veins. They are thus carried by the blood-stream to the heart and thence to the lungs. Ascending the bronchi and trachea, they enter the mouth and are swallowed. Their ultimate habitat, the small intestine, may be reached within seven to ten days after their entry into the body. Here, in the course of a further two to four weeks, the worms undergo two more moults and become sexually mature.

2. *Ancylostoma caninum* (Ercolani, 1859) v. Linstow, 1889.
(Fig. 146, B.)

Synonyms:—*Dochmius trigonocephalus* (Rud.) of Ercolani, 1859 (part); *Sclerostoma caninum* Ercolani, 1859; *Strongylus caninus* Ercolani, 1859; *Dochmius balsami* Parona and Grassi, 1877; *Uncinaria trigonocephala* Railliet, 1885; *Ankylostomum tubæforme* v. Linstow, 1885; *Ankylostoma trigonocephalum* Blanchard, 1888, nec Looss, 1898; *Ankylostomum trigonocephalum* v. Linstow, 1889; *Ankylostomum caninum* v. Linstow, 1889; *Ankylostoma caninum* Ward, 1895; *Anchylostomum trigonocephalum* Looss, 1897; *Uncinaria tubæformis* Galli-Valerio, 1898; *Uncinaria canina* Railliet, 1900; *Agchylostoma caninum* Stiles, 1903; *Anchylostoma caninum* Loeb and Smith, 1904; *Ancylostoma trigonocephalum* Braun and Lühe, 1909; *Ancylostomum caninum* Gomez de Faria, 1910; *Ancylostoma* (*Ancylostoma*) *caninum* Lane, 1916; ? *Strongylus tubæformis* Zeder, 1800; ? *Strongylus trigonocephalus* Rudolphi, 1808 (part)*.

Hosts:—This is a common and widely-distributed parasite of the dog. From this host it has been recorded in the Punjab by several authors, and in Ceylon by v. Linstow. It may also occur in a number of other carnivores. Baylis and Daubney (1922, 1923, b) record it from the following animals, mainly in the Zoological Gardens, Calcutta:—Wild dog (*Cyon dukhunensis*), Indian wolf (*Canis pallipes*), Indian jackal (*Canis aureus*), Indian fox (*Vulpes bengalensis*), Indian desert fox (*Vulpes leucopus*), sloth-bear (*Melursus ursinus*), tiger (*Felis tigris*), leopard (*Felis pardus*), fishing cat (*Felis viverrina*) and domestic cat. *A. caninum* has been recorded as a human parasite in the Philippines, but its occurrence in man appears to be very rare.

The measurements in the following description are taken mainly from Lane (1916).

The male measures, on an average, 10 mm. in length and 0.4 mm. in maximum thickness, the female 14 mm. and 0.6 mm. respectively. The cuticular striations are at intervals of 10 μ . The buccal capsule measures 0.25 mm. in length, and there are three pairs of large ventral teeth. The œsophagus is about 1.1 mm. long. The nerve-ring is situated at 0.72 mm., the cervical papillæ at 0.75 mm., and the excretory pore at 0.8 mm., from the anterior end.

The medio-lateral and postero-lateral rays of the bursa are rather widely separated. The spicules are about 0.9 mm. long, the accessory piece 0.16 mm.

The tail of the female is about 0.2 mm. long. The vulva is situated at about the posterior third of the body. The eggs measure about 0.06–0.064 \times 0.03–0.04 mm.

* Rudolphi's species seems to have included *A. caninum* and *Bunostomum trigonocephalum*, and this has resulted in much confusion.

3. *Ancylostoma minimum* (v. Linstow, 1906) Lane, 1916.

Synonyms :—*Ankylostomum minimum* v. Linstow, 1906 ; *Uncinaria minima* Railliet and Henry, 1909.

Host :—Rusty-spotted cat (*Felis rubiginosa*) (stomach) ; Kandy, Ceylon.

Of this species nothing appears to be known beyond the brief account of it given by v. Linstow, and it is doubtful whether it can be recognized. The type-specimens do not appear to be available in the Colombo Museum.

According to v. Linstow the male measures 2.38 mm. in length and 0.24 mm. in thickness, the female 4.46 mm. and 0.2 mm. respectively. The buccal capsule is dorsally inclined, and has four ventral longitudinal "ribs" and "a tooth at the bottom." The œsophagus occupies $1/5.8-1/4$ of the total length. The spicules of the male are brown and very short (0.062 mm. long). The tail of the female measures $1/34$ of the total length. The vulva is posteriorly situated, dividing the body in the proportion of 31 : 12. The genital organs are almost confined to the posterior half of the body. The eggs measure 0.088×0.053 mm.

4. *Ancylostoma braziliense* (Gomez de Faria, 1910). (Fig. 146, C.)

Synonyms :—*Ancylostomum braziliense* Gomez de Faria, 1910 ; *Ankylostoma braziliense* Gedoelst, 1911 ; *Uncinaria braziliensis* Railliet, 1911 ; *Agchylostoma ceylanicum* Looss, 1911 ; *Ankylostoma ceylanicum* Lane, 1913 ; *Agchylostoma braziliense* Gomez de Faria, 1914 ; *Ancylostoma ceylanicum* Leiper, 1915 ; *Ancylostoma (Ceylancylostoma) ceylanicum* Lane, 1916.

Hosts :—This species, which is widely distributed in tropical and subtropical countries, is a common parasite of dogs and cats, and also occurs not infrequently in man. In India it was recognized in man for the first time by Lane, in 1913, in prisoners who had been transferred from the Mymensingh Jail to Berhampore. It was previously recorded by Looss from the small Indian civet (*Viverricula malaccensis*) from Colombo, Ceylon. Baylis and Daubney (1922) record it from the following animals, mainly in the Zoological Gardens, Calcutta :—Civet (probably *Viverricula malaccensis*), tiger (*Felis tigris*), lion (*F. leo*), leopard (*F. pardus*), fishing cat (*F. viverrina*), leopard cat (*F. bengalensis*), domestic cat, wild dog (*Cyon dukhunensis*), Indian wolf (*Canis pallipes*), sloth-bear (*Melursus ursinus*) and red cat-bear (*Ælurus fulgens*).

The measurements in the following description are taken mainly from Lane (1916).

The male measures about 7·7–8·5 mm. in length and 0·35 mm. in maximum thickness, the female 9–10·5 mm. and 0·375 mm. respectively. The cuticular striations are at intervals of $7\cdot5\mu$. The buccal capsule measures 0·175 mm. in length, and the ventral teeth consist of one large pair and a rudimentary inner pair. The œsophagus is about 0·75 mm. long. The nerve-ring is situated at 0·46 mm., and the cervical papillæ and excretory pore at 0·6 mm., from the anterior extremity.

The medio-lateral and postero-lateral rays of the bursa are close together. The spicules are about 0·8 mm. long, the accessory piece 0·075 mm.

The tail of the female measures 0·16 mm. in length. The vulva is situated at about 3·5 mm. from the posterior end. The eggs measure $0\cdot05\times 0\cdot03$ mm.

5. *Ancylostoma malayanum* (Alessandrini, 1905). (Fig. 147.)

Synonyms:—*Uncinaria malayana* Alessandrini, 1905; *Ankylostoma malayanum* Railliet and Henry, 1909; *Agchylostoma malayanum* Looss, 1911; *Ancylostoma malayanicum* Stephens, 1916; *Ancylostoma (Ceylancylostoma) malayanum* Lane, 1916.

Hosts:—This species appears to be confined to bears, and does not seem to have been found outside the Indo-Malay region. It was originally recorded from the Malay bear (*Ursus [Helarctos] malayanus*). In India it has been recorded

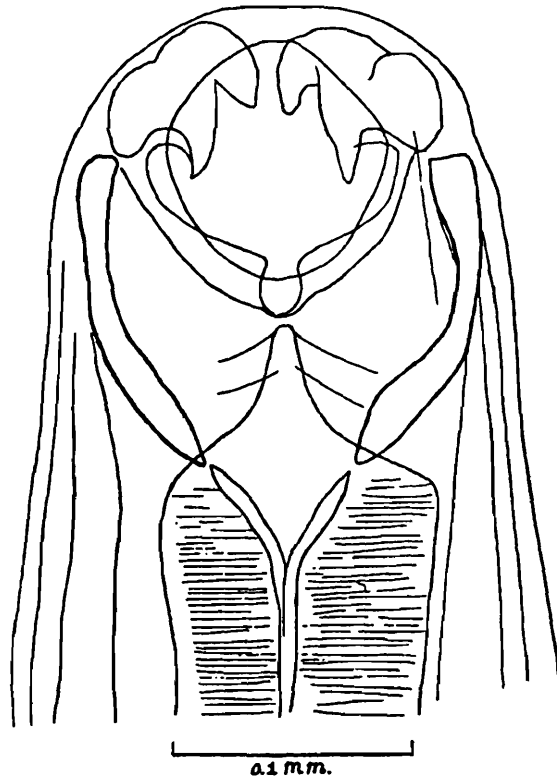

Fig. 147.—*Ancylostoma malayanum*. Anterior end; dorsal view. (After Lane.)

by Lane (1916) from a wild Himalayan bear (*Ursus torquatus*), and also by Baylis and Daubney (1922) from *Ursus malayanus* and from a "bear" which was probably the sloth-bear (*Melursus ursinus*). These last two records refer to material probably collected in the Zoological Gardens, Calcutta.

The measurements in the following description are taken mainly from Lane (1916).

The male measures 11.5–15 mm. in length, the female 15–19 mm. In both sexes the maximum thickness is about 0.6 mm. The cuticular striations are at intervals of 6.25μ . The buccal capsule measures 0.185 mm. in length. There are two pairs of ventral teeth, the inner pair being well developed, though considerably smaller than the outer. The œsophagus is about 1.7 mm. long. The nerve-ring, cervical papillæ and excretory pore are all situated at about 0.72 mm. from the anterior extremity.

The medio-lateral and postero-lateral rays of the bursa are close together. The spicules are 3 mm. long, the accessory piece 0.1 mm.

The tail of the female measures 0.125 mm. in length. The vulva is situated at about 7 mm. from the posterior end. The eggs measure 0.055×0.03 mm.

2. Genus **GALONCUS** Railliet, 1918.

Anterior end bent dorsally. Mouth-opening guarded by two or three pairs of ventral teeth. Buccal capsule relatively small, cup-shaped and imperfectly chitinized, with one or two pairs of teeth towards its base. Bursa with a small dorsal lobe. Externo-dorsal rays arise from the main stem of the dorsal ray. The cleft portion of the dorsal ray is very short in comparison with its total length. Its terminations are tridigitate, *i. e.* there are two accessory branches on each branch. Spicules long and filiform, apparently united at their tips. An accessory piece present. Vulva towards the posterior quarter of the body. Uterine branches opposed. Adult worms in submucous cysts in the intestine of Felidæ.

Genotype :—*Galoncus perniciosus* (v. Linstow, 1885).

1. **Galoncus perniciosus** (v. Linstow, 1885) Railliet, 1918.

Synonyms :—*Strongylus tubæformis* of v. Linstow, 1879; *Ankylostomum perniciosum* v. Linstow, 1885; *Uncinaria perniciosa* Cohn, 1899; *Ancylostoma perniciosum* Ihle, 1919.

Hosts :—This species has been recorded on several occasions from tigers and leopards, chiefly in menageries in Europe. Baylis and Daubney (1922) record a single specimen collected from the intestine of a leopard (*Felis pardus*) in the Zoological

Gardens, Calcutta. The worm occurs in fibrous nodules or tumours of the wall of the intestine, and its presence frequently leads to the death of the host from septicæmia.

The male measures about 8–14 mm. in length and 0.36 mm. in maximum thickness, the female 11.6–17.4 mm. and 0.4 mm. respectively. The cuticular striations are at varying intervals—according to Railliet, 4–5 μ anteriorly, 21 μ in the middle of the body and 13 μ at the level of the vulva. The anterior end of the body is retractile. The buccal capsule measures about 0.07–0.08 mm. in length, and its diameter, according to Railliet, is 0.08 mm. in front and 0.04 mm. behind. The œsophagus is about 0.8–1 mm. long. The nerve-ring is situated at 0.47 mm., and the cervical papillæ at 0.73 mm., from the anterior end.

The spicules measure 1.7–2 mm. in length, the accessory piece, according to Ihle, 0.045 mm.

The tail of the female narrows rather suddenly a little behind the anus, and ends in a small spike. It measures 0.15–0.225 mm. in length. The vulva is situated at 2.8–3.6 mm. from the posterior end. The eggs measure 0.063–0.072 \times 0.038–0.042 mm.

3. Genus **AGRIOSTOMUM** Railliet, 1902.

Mouth-opening circular, guarded by four pairs of teeth which, with the exception of the subventral pair, are double. Dorsal gutter ends in a freely-projecting process which is grooved and sometimes appears bifid. Buccal capsule shallow. Œsophageal funnel very large, containing one or two pairs of subventral lancets. A ventral cervical groove may be present. Antero-lateral ray of bursa thicker than, and somewhat divergent from, the other lateral rays. Externo-dorsal rays spring from the median dorsal stem about half-way between its root and its bifurcation. Dorsal ray cleft for about one-third of its length; its terminations bidigitate. Spicules equal, alate. An accessory piece [or telamon] present. Vulva close to anus. Adult worms in the intestine of ruminants.

Genotype:—*Agriostomum vryburgi* Railliet, 1902.

1. **Agriostomum vryburgi** Railliet, 1902. (Fig. 148).

Host:—Zebu (*Bos indicus*) (duodenum). The species was originally recorded by Railliet from Sumatra. In India it has been recorded by Lane (1923) from Darjeeling, and by Ware (1925) from the Nilgiri Hills, South India.

The male measures 9.2–11 mm. in length and 0.29–0.35 mm. in maximum thickness, the female 13–15.5 mm. and 0.39–

0.45 mm. respectively. The cuticular striations are very fine and inconspicuous, the interval between them being about 2.5μ according to Ware. A ventral cervical groove is present in this species (though not in all members of the genus), in which the excretory pore is situated, at about 0.42–0.45 mm. from the anterior end. The buccal capsule is very shallow, its depth being only about 0.05 mm. on the ventral side and less than half as much on the dorsal side, according to Ware. Its diameter, according to Lane, is 0.13 mm. The four pairs of teeth surrounding its opening are of nearly equal size. According to Mönnig (1932, *a*), each tooth has a small internal tubercle at its base. The œsophageal

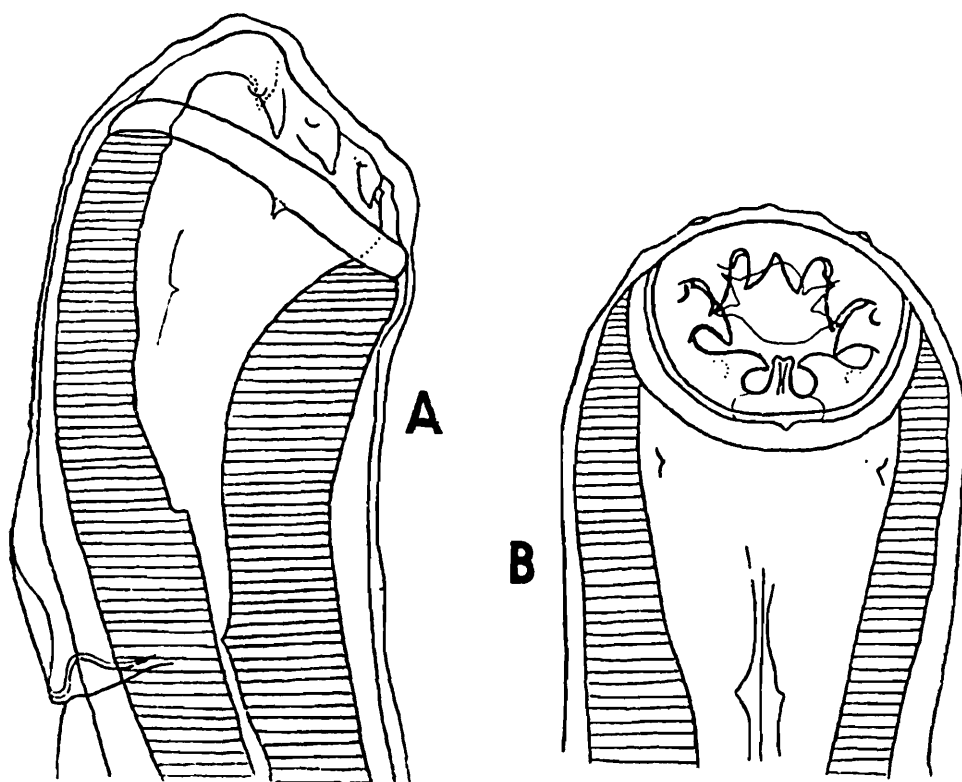

Fig. 148.—*Agriostomum vryburgi*. Anterior end. A, lateral view; B, dorsal view. (After Mönnig.)

funnel is about 0.25 mm. long. According to Mönnig it contains two pairs of very small subventral lancets, one in front of its middle and one towards its narrow posterior end. These had not been seen by previous observers. The œsophagus is about 1–1.1 mm. long. The cervical papillæ and nerve-ring are situated at about 0.47–0.55 mm. from the anterior extremity.

The spicules measure 0.83–0.87 mm. in length, and have wide, transversely-striated alæ. The accessory piece is 0.09 mm. long, according to Lane. Ware describes it as “clavicular in a lateral view, but heart-shaped in a frontal view.”

The tail of the female is 0.15–0.26 mm. long, and tapers rapidly to a fine point. The vulva is situated at 0.47–0.6 mm. from the posterior end. The eggs measure 0.125–0.195 × 0.06–0.092 mm. Their contents are segmenting at the time of laying.

Subfamily NECATORINÆ Lane, 1917

Anterior margin of buccal capsule without teeth, but usually bearing ventral cutting-plates.

Key to Genera.

Buccal capsule without marginal ventral cutting-plates	[p. 328.
Buccal capsule with marginal ventral cutting-plates	GLOBOCEPHALUS,
1. An intestinal cæcum present	1. [p. 341.
Intestinal cæcum absent	GRAMMOCEPHALUS,
2. Buccal capsule fissured dorsally and laterally, and with transverse "shelves" internally.	2. [p. 343.
Buccal capsule entire, without transverse "shelves," but with lancets or teeth near its base	BATHMOSTOMUM,
3. Dorsal lobe of bursa of male asymmetrical.	3. [p. 331.
Dorsal lobe of bursa symmetrical	BUNOSTOMUM,
4. Two pairs of lancets or teeth present in buccal capsule	4.
One pair of lancets present	5.
5. Subventral lancets and subdorsal teeth simple.	6. [p. 326.
Subventral lancets and subdorsal teeth bicuspid or tricuspid	NECATOR, p. 326.
6. Dorsal cone projects freely into lumen of buccal capsule; dorsal lobe of bursa of male larger than lateral lobes	[p. 339.
Dorsal cone does not project into lumen of buccal capsule; dorsal lobe of bursa smaller than lateral lobes	TETRAGOMPHIUS,
	GAIGERIA, p. 335.
	UNCINARIA, p. 336.

1. Genus **NECATOR** Stiles, 1903.

Anterior end bent dorsally. Mouth-opening guarded by a pair of cutting-plates. Buccal capsule large, subglobular. At its base a pair of subventral lancets, a pair of subdorsal teeth and a prominent dorsal cone projecting into the lumen and carrying the dorsal gutter. Bursa with two large lateral lobes and a small dorsal lobe. Externo-dorsal rays relatively long and slender, arising high up on the stem of the dorsal ray, which is cleft for almost the whole of its length. Its terminations are bidigitate, *i. e.* there is a single pair of accessory branches. Spicules slender, barbed. Vulva slightly in front of the middle of the body. Uterine branches opposed. Adult worms in the intestine of mammals, chiefly Primates.

Genotype :—*Necator americanus* (Stiles, 1902).

1. *Necator americanus* (Stiles, 1902) Stiles, 1903. (Fig. 149.)

Synonyms:—*Uncinaria americana* Stiles, 1902; *Ankylostomum americanum* v. Linstow, 1903; *Uncinaria (Necator) americana* Stiles, 1903; *Anchylostomum americanum* Loeb and Smith, 1904; *Necator africanus* Harris, 1910; ? *Necator suillus* Ackert and Payne, 1922.

Hosts:—This species occurs in almost all tropical and subtropical parts of the world, its principal host being man. It is the common hookworm of the New World, but is also very common in Oriental countries, and is thought to have been introduced into America from Africa. In addition to man, it has been recorded from the gorilla and other Primates, and also from the pig, rhinoceros and pangolin, and (rarely) from the dog. According to some observers—*e. g.* Maplestone (1929, *b*), Kendrick (1929)—it is commoner in man in India than is *Ancylostoma duodenale*. Specimens were recorded by Baylis

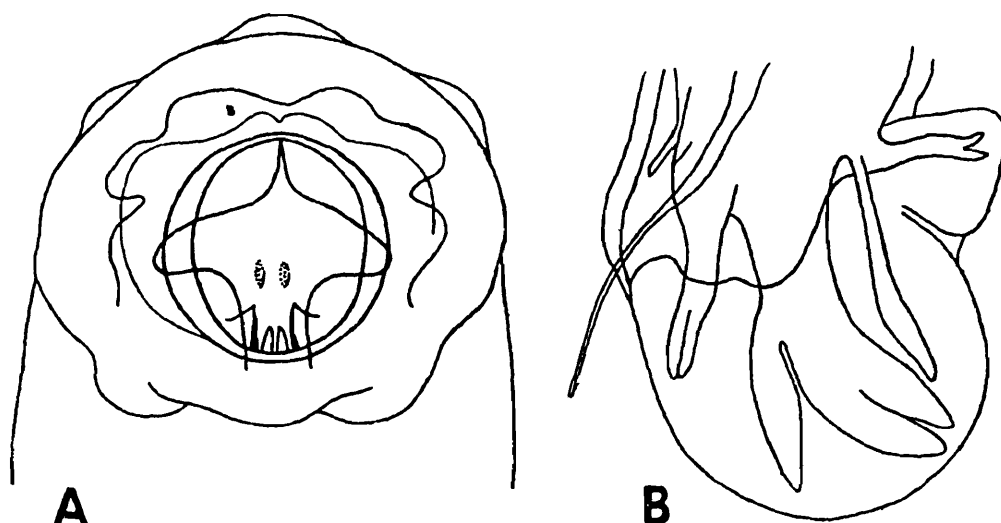

Fig. 149.—*Necator americanus*. A, anterior end, dorsal view; B, bursa of male, lateral view. (After Faust.)

and Daubney (1922) from a young African rhinoceros (*Rhinoceros bicornis*) which had lived only a short time in the Zoological Gardens, Calcutta, and had been imported from Tanganyika Territory. Later the same authors (1923, *b*) recorded a single female specimen from a wild Indian rhinoceros (*Rhinoceros unicornis* [*R. indicus*]).

The male measures about 5.2–10 mm. in length and 0.18–0.3 mm. in maximum thickness, the female 7–13.5 mm. and 0.38–0.45 mm. respectively. The buccal capsule measures about 0.08–0.14 mm. in length and 0.07–0.12 mm. in width. The œsophagus is about 0.5–0.8 mm. long. The cervical papillæ are situated at about 0.37 mm., the nerve-ring at 0.4 mm., and the excretory pore at 0.5 mm., from the anterior extremity.

The spicules of the male are about 0.92 mm. long.

The tail of the female measures about 0.17 mm. in length. The vulva is situated in front of the middle of the body, at about 4.3 mm. from the anterior end in a specimen of average size. The eggs measure 0.053–0.076 × 0.028–0.044 mm.

2. Genus **GLOBOCEPHALUS** Molin, 1861.

Synonyms :—*Cystocephalus* Railliet, 1895, *nec* Lager, 1892 ; *Characostomum* Railliet, 1902 ; *Crassisoma* Alessandrini, 1909 ; *Raillietostrongylus* Lane, 1923.

Relatively stout forms without cutting-plates at the anterior margin of the buccal capsule. Buccal capsule deep, infundibular or subglobular, supported anteriorly by an external chitinoid ring. Mouth-opening tilted dorsally. There may or may not be a pair of teeth or lancets at the base of the buccal capsule. Dorsal gutter extends almost to the mouth-opening. Dorsal ray of bursa cleft for only a short portion of its length ; its terminations tridigitate. Spicules slender, curved dorsally at their tips or bent into an S-shape. An elongate accessory piece present. Vulva in posterior half of body. Uterine branches opposed. Adult worms in the alimentary tract of pigs and monkeys.

Genotype :—*Globocephalus longemucronatus* Molin, 1861.

Key to Species.

- | | |
|--|-------------------------------|
| Teeth in buccal capsule bicuspid | <i>samoensis</i> , p. 330. |
| Teeth in buccal capsule simple and triangular or ridge-like | 1. |
| 1. Buccal capsule subglobular ; bases of teeth extend to its extreme posterior end | <i>urosubulatus</i> , p. 328. |
| Buccal capsule funnel-shaped ; bases of teeth do not reach its posterior end | <i>connorfilii</i> , p. 329. |

1. **Globocephalus urosubulatus** (Alessandrini, 1909).

Synonyms :—*Crassisoma urosubulatum* Alessandrini, 1909 ; ? *Characostomum amucronatum* Smit and Noto-Soediro, 1926 ; ? *Globocephalus amucronatus* Smit and Ihle, 1928.

Host :—This is a parasite of the pig, and was originally recorded from Italy. Maplestone has recorded it from pigs slaughtered in Calcutta.

Cameron (1924, *b*), after examining Lane's type-specimens of *Globocephalus connorfilii*, considered this species a synonym of *G. urosubulatus*, a view which was accepted by the writer (1929). Maplestone (1930, *a*), however, on the basis of a large amount of material collected in Calcutta, recognizes the two species as distinct. There is in reality considerable uncertainty as to the identification of Alessandrini's species, but for the present Maplestone's view may be adopted provisionally.

On the other hand, Maplestone includes *G. amucronatus* (Smit and Noto-Soediro, 1926) Smit and Ihle, 1928, in his synonymy of *G. urosbulatus*, but the evidence for this conclusion is not very convincing.

The following description of "*G. urosbulatus*" is taken from Maplestone.

The male measures 3.99–4.69 mm. in length and 0.297–0.376 mm. in maximum thickness, the female 4.74–6.87 mm. and 0.336–0.475 mm. respectively. The buccal capsule is subglobular and measures 0.14–0.2 mm. in depth and 0.084–0.14 mm. in internal diameter. A pair of teeth, triangular and of variable size, arise "from the posterior part of the ventral wall of the capsule, the posterior border of the tooth running to the extreme posterior edge of the capsule, where it joins the œsophagus."

The spicules of the male are 0.852–0.931 mm. long (Alessandrini gives 0.59 mm.)

The tail of the female measures 0.12–0.196 mm. in length.

2. *Globocephalus connorfilii* Lane, 1922. (Fig. 150.)

Host:—Pig (small intestine); originally recorded from Samoa; recorded by Maplestone (1930, *a*) from pigs slaughtered

Fig. 150.



Fig. 151.

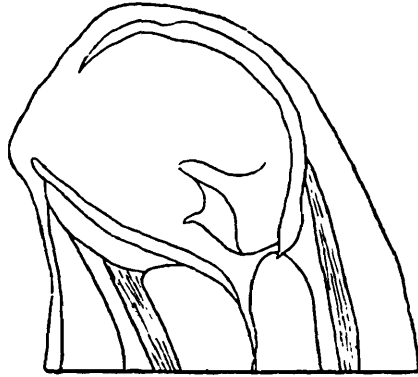

Fig. 150.—*Globocephalus connorfilii*. Anterior end; lateral view. (After Lane.)

Fig. 151.—*Globocephalus samoensis*. Anterior end; lateral view. (After Lane.)

in Calcutta. As has already been explained under *G. urosbulatus*, Maplestone considers this species valid. The following description is based mainly on his account of it.

The male measures about 4–5 mm. in length and 0.24–0.34 mm. in maximum thickness, the female 4.1–6.5 mm. and 0.3–0.45 mm. respectively. The cuticular striations, according to Lane, are at intervals of 9 μ . The buccal capsule is not subglobular, but somewhat funnel-shaped. It measures 0.12–0.212 mm. in length and 0.068–0.108 mm. in internal diameter. The teeth arise somewhat further forward on the

ventral wall of the capsule than in *G. urosubulatus*. "They are more in the nature of longitudinal ridges with a curved outline, and the posterior border always fuses with the capsule wall some distance anterior to its junction with the œsophagus." In some specimens these ridges are faint and not surmounted by a point, and "in extreme cases even these faint ridges are absent." The œsophagus is 0.625–0.75 mm. long, measured from the anterior extremity, and is club-shaped. According to Lane, the cervical papillæ, nerve-ring and excretory pore are all situated at 0.375–0.45 mm. from the anterior end.

The spicules of the male measure, according to Maplestone, 0.455–0.594 mm. in length. Lane, in 1922, gave their length as 0.275 mm., but in 1923 as 0.54 mm. The accessory piece measures, according to Lane, 0.09 mm. in length and is "somewhat canoe-shaped in lateral, kite-shaped with the point posterior in dorsal, view."

The tail of the female is about 0.13–0.21 mm. long, and bears a pair of papillæ at 0.04 mm. from the tip. The vulva, according to Lane, is situated at 2–2.4 mm. from the posterior end, and the eggs measure 0.06 × 0.04 mm.

3. *Globocephalus samoensis* Lane, 1922. (Fig. 151.)

Host:—Pig (small intestine); originally recorded from Samoa, but recorded by Maplestone (1930, *a*) from pigs slaughtered in Calcutta.

The following description is taken mainly from Lane (1922, *b*; 1923). The male measures about 4.2–5.7 mm. in length and 0.3 mm. in maximum thickness, the female about 5.3–6.7 mm. and 0.35 mm. respectively. The cuticular striations are at intervals of 9 μ . The buccal capsule is "nearly circular, guarded by most rudimentary ventral semilunes, and bearing posteriorly a pair of large, stout, *bicuspid* teeth, thickened ventro-anteriorly." The capsule measures 0.14 mm. in length, 0.12 mm. in transverse and 0.11 mm. in dorso-ventral diameter. The œsophagus is about 0.75 mm. long. The nerve-ring is situated at 0.4 mm., the excretory pore at 0.425–0.44 mm., and the cervical papillæ at 0.44–0.45 mm., from the anterior extremity.

The spicules of the male measure about 0.4 mm. in length (according to Maplestone, 0.376–0.495 mm.) The accessory piece, which is diamond-shaped in dorsal view, is 0.055 mm. long.

The tail of the female is 0.084–0.124 mm. long, according to Maplestone (0.095 mm., without the terminal spike, according to Lane). The caudal papillæ are situated at 0.015 mm. from the tip. The vulva is situated at about 2 mm. from the posterior end. The eggs measure 0.065–0.07 × 0.04 mm.

3. Genus **BUNOSTOMUM** Railliet, 1902.

Synonyms :—*Monodontus* Molin, 1861 (part); *Bustomum* Lane, 1917.

Anterior end bent dorsally. Mouth guarded by a pair of ventral cutting-plates. Buccal capsule large, infundibular. Towards its base a strong dorsal tooth along which runs the dorsal gutter, and one or two pairs of smaller ventral lancets. Bursa with an asymmetrical dorsal lobe. The right externo-dorsal ray arises high up on the main dorsal stem and is long and slender. The left externo-dorsal ray is much shorter and arises at about the level of the bifurcation of the dorsal ray. Terminations of dorsal ray tridigitate. Spicules slender, not barbed. Vulva a little in front of the middle of the body. Uterine branches opposed. Adult worms in the small intestine of ruminants.

Genotype :—*Bunostomum trigonocephalum* (Rudolphi, 1808).

Key to Species.

- | | |
|---|--------------------------------------|
| Dorsal border of dorsal tooth longer than the distance from its tip to the mouth-opening ;
spicules of male about 0.6–0.75 mm. long .. | [p. 331.
<i>trigonocephalum</i> , |
| Dorsal border of dorsal tooth shorter than the distance from its tip to the mouth-opening. | 1. [p. 334. |
| 1. Subventral lancets in buccal capsule two pairs. | <i>phlebotomum</i> |
| Subventral lancets one pair | 2. |
| 2. Spicules of male about 4.5 mm. long | <i>bovis</i> , p. 334. |
| Spicules of male about 0.6 mm. long | <i>cobi</i> , p. 333. |

1. **Bunostomum trigonocephalum** (Rud., 1808) Railliet, 1902.
(Figs. 152 & 153.)

Synonyms :—*Strongylus trigonocephalus* Rudolphi, 1808 (part); *Strongylus cernuus* Creplin, 1829; *Sclerostoma hypostomum* Dujardin, 1845 (part); *Dochmius hypostomus* Diesing, 1851 (part); *Monodontus wedlii* Molin, 1861; *Dochmius cernuus* Baillet, 1868; *Uncinaria cernua* Railliet, 1885; *Ankylostoma cernuum* Blanchard, 1888; *Monodontus cernuus* Rizzo, 1900; *Strongylus* (*Monodontus*) *cernuus* Railliet, 1900; *Uncinaria* (*Monodontus*) *cernua* Railliet, 1900; *Uncinaria* (*Monodontus*) *trigonocephala* Railliet, 1900; *Monodontus trigonocephalus* Railliet, 1900; *Ankylostomum cernuum* v. Linstow, 1906; *Bunostomum kashinathi* Lane, 1917.

Hosts :—This is a parasite of the small intestine of the sheep, goat, ox and other ruminants. Lane (1917, a) has recorded it from the sheep in the Darjeeling district of Bengal. At the same time he recorded, under the name of *B. kashinathi*, a form from the goat in the same locality. Lane believed that *B. kashinathi* was a distinct species, on the ground of certain slight differences in the shape of the buccal capsule and other

Fig. 152.

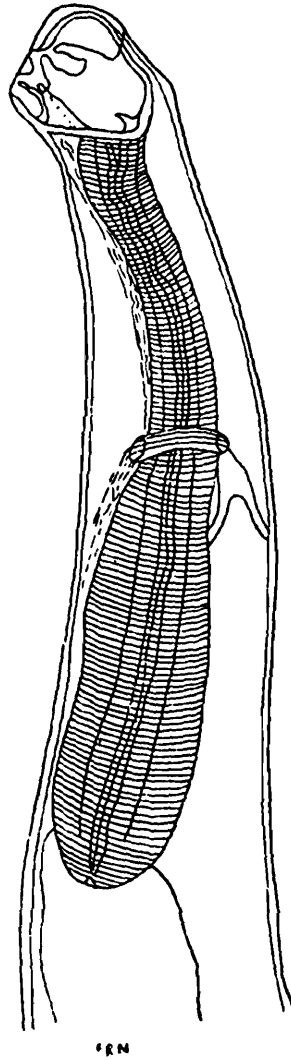

Fig. 153.

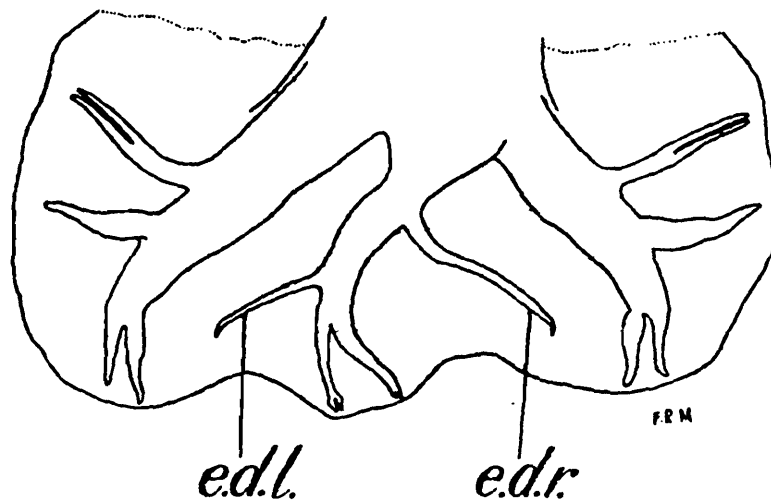

Fig. 152.—*Bunostomum trigonocephalum*. Anterior end; lateral view.
(From Baylis, after Ransom.)

Fig. 153.—*Bunostomum trigonocephalum*. Bursa of male; dorsal view.
e.d.l., left externo-dorsal ray; *e.d.r.*, right externo-dorsal ray.
(From Baylis, after Ransom.)

structures. He admits, however, that the measurements of the forms from the two hosts do not provide convincing specific differences. Yorke and Maplestone (1926) have placed *B. kashinathi* in the synonymy of *B. trigonocephalum*, and the writer follows them, believing that some of the supposed distinctions between the species are merely the result of individual variation, and others probably the result of differences in the condition of the preserved material.

The male measures 11–17 mm. in length and 0.4 mm. or more in maximum thickness, the female 14–26 mm. and 0.45–0.75 mm. respectively. The cuticular striations are at intervals of 6–7.5 μ . The buccal capsule measures 0.17–0.225 mm. in length, 0.16–0.165 mm. in transverse and 0.15–0.175 mm. in dorso-ventral diameter. The dorsal tooth is relatively long, and its dorsal border is longer than the distance from its tip to the mouth-opening. There is usually one pair of subventral lancets, but a smaller second pair is occasionally present. The œsophagus is 0.8–1.45 mm. long. The nerve-ring is situated at about 0.6 mm., and the cervical papillæ and excretory pore at 0.6–0.75 mm., from the anterior end.

The spicules measure 0.6–0.75 mm. in length, and are slightly twisted and provided with striated alæ.

The tail of the female is 0.25–0.4 mm. long, and bears a pair of papillæ at about 0.08–0.12 mm. from the tip. The vulva, which is usually not prominent, is situated at 5.5–8 mm. from the anterior end. The vagina is short (about 0.2 mm.). The combined length of the muscular portions of the ovejectors is, according to Ransom (1911), at least 0.45 mm. The eggs measure 0.075–0.085 \times 0.038–0.05 mm.

2. *Bunostomum cobi* Maplestone, 1931.

Synonym :—? *Bunostomum dentatum* Mönnig, 1931*.

Host :—Waterbuck (*Cobus ellipsiprymnus*); Zoological Gardens, Calcutta.

This species appears to be very similar to *B. trigonocephalum*. The male measures 8.8–11.4 mm. in length and 0.29–0.32 mm. in maximum thickness, the female 15–16 mm. and 0.45–0.5 mm. respectively. The buccal capsule is funnel-shaped in lateral view and measures 0.164–0.176 mm. in length.

* The worms described by Mönnig (1931), from the same host in its native country (South Africa), though slightly larger and differing in certain details of measurements, were almost certainly of the same species as Maplestone's, whose description appears to have been published earlier.

The dorsal tooth is truncate at the tip, and its dorsal border is about half as long as the distance from its tip to the mouth-opening. "There is a single pair of broad rounded subventral lancets, which may or may not have sharp points on their summits." The œsophagus is "0.18–0.2" [? 1.8–2] mm. long.

The bursa of the male has a clearly-defined dorsal lobe. The spicules resemble those of *B. trigonocephalum* and measure 0.55–0.66 mm. in length.

The tail of the female is 0.37–0.46 mm. long, and is straight, with a blunt tip. It bears a pair of papillæ at about 0.15 mm. from the tip. The vulva is slightly prominent and is situated at 4.2–5.7 mm. from the anterior extremity. The vagina is short. The eggs measure 0.058–0.06 × 0.036 mm.

3. *Bunostomum bovis* Maplestone, 1931.

Host:—Zebu (*Bos indicus*) (abomasum); recorded by Maplestone as occurring in small numbers in animals which died at the Government Experimental Farm at Gauhati, Assam.

Both sexes measure 15–16 mm. in length and about 0.5 mm. in maximum thickness. The cuticle is coarsely striated. The buccal capsule is rather elongate. The dorsal border of the dorsal tooth is shorter than the distance from the tip of the tooth to the mouth-opening. There is a single pair of long, pointed subventral lancets. The excretory pore is situated at about 0.7 mm. from the anterior end.

The spicules are about 4.5 mm. long, and are slender and tapering, with "fine straight points, which are fused and surrounded by a membranous sheath."

The tail of the female is 0.34 mm. long, and is straight, with a blunt tip. The vulva is an inconspicuous slit situated a little in front of the middle of the body (at about 8.5 mm. from the posterior end). The vagina is short. The eggs measure 0.072–0.076 × 0.044–0.046 mm.

4. *Bunostomum phlebotomum* (Railliet, 1900) Railliet, 1902.

Synonyms:—*Strongylus radiatus* Schneider, 1866, *nec* Rudolphi, 1803, *nec* Gurlt, 1831; *Dochmius radiatus* Leuckart, 1868; *Uncinaria radiata* Railliet, 1885; *Monodontus phlebotomus* Railliet, in Rizzo, 1900; *Strongylatus radiatus* Railliet, 1900; *Bunostomum radiatum* v. Linstow, 1906; *Bustomum phlebotomum* Lane, 1917.

Hosts:—This parasite occurs in the small intestine of the ox, zebu (*Bos indicus*) and sheep. Railliet has recorded it from the two former hosts in British India.

The following description is taken from Ransom (1911). The male measures 10–12 mm. in length and nearly 0.5 mm. in maximum thickness, the female 16–19 mm. and a little more than 0.5 mm. respectively. The dorsal tooth in the buccal capsule is relatively short, and its dorsal border is shorter than the distance from its tip to the mouth-opening. There are two pairs of subventral lancets. The œsophagus is 1.25–1.5 mm. long. The cervical papillæ are situated at about its anterior third.

The spicules are alate and measure 3.5–4 mm. in length.

The tail of the female is 0.4–0.5 mm. long. The vulva is rather prominent and is situated a little in front of the middle of the body. The vagina is long and sinuous. The combined length of the muscular portions of the ovejectors is at least 1 mm. The eggs measure $0.075\text{--}0.098 \times 0.04\text{--}0.05$ mm.

4. Genus **GAIGERIA** Railliet and Henry, 1910.

Anterior end bent dorsally. Mouth-opening oval and guarded by a pair of ventral cutting-plates. Buccal capsule large and cup-shaped. At its base a freely-projecting cone carrying the dorsal gutter, and a pair of subventral lancets. Bursa with a large dorsal lobe and two much smaller lateral lobes which are joined ventrally. Antero-lateral rays short, blunt and widely separated from the other lateral rays. Externo-dorsal rays originate from the main trunk of the dorsal ray. Dorsal ray cleft for a considerable portion of its length; its branches stout, blunt and ending in three very small digitations. Spicules with slender, recurved terminations, without barbs. No accessory piece. Vulva just in front of the middle of the body. Adult worms in the alimentary tract of ruminants.

Genotype :—*Gaigeria pachyscelis* Railliet and Henry, 1910.

1. **Gaigeria pachyscelis** Railliet and Henry, 1910. (Fig. 154.)

Synonym :—*Gaigeria smiti* Noto-Soediro, 1928.

Hosts :—This species was originally obtained from the intestine of the sheep, and doubtfully from the ox, in the Punjab by Gaiger, who states that it is not common. Cameron (19 4, a), who has redescribed the worm, records it from the goat in India.

The male measures 11–18 mm. in length and 0.55–0.65 mm. in maximum thickness, the female 15–24 mm. and 0.7–0.85 mm. respectively. The cuticular striations are at intervals of 8–10 μ . The greatest length of the buccal capsule is about

0.3–0.36 mm., and its dorso-ventral diameter about 0.21–0.33 mm. The œsophagus is slender, and measures about 2–3 mm. in length and 0.2 mm. in diameter. The cervical papillæ, nerve-ring and excretory pore are situated a little in front of the middle of the œsophagus, at about 0.93 mm. from the anterior extremity.

The spicules are 1.1–1.328 mm. long. Each has “ a stoutish stem, and a very fine flexible point about .2 mm. long. The

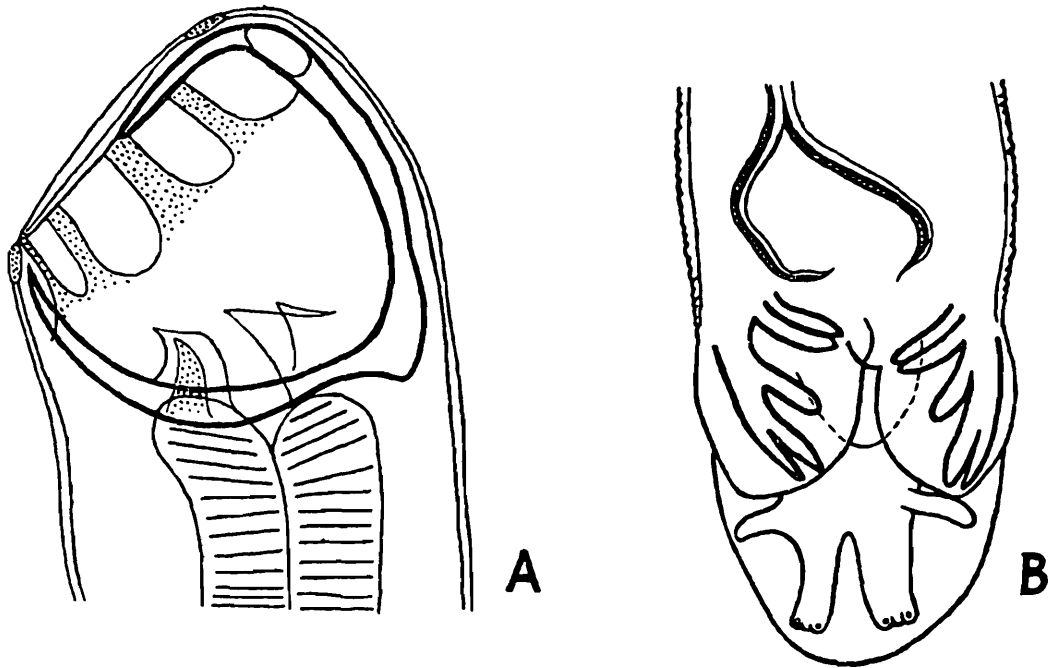

Fig. 154.—*Gaigeria pachyscelis*. A, anterior end, lateral view; B, posterior end of male, ventral view. (After Yorke and Maplestone.)

main stem consists of a solid rod set with numerous fine recurved teeth at its outer edge” (*Cameron*).

The tail of the female is about 0.31–0.41 mm. long. It is narrowed suddenly behind the anus and has a blunt tip. The vagina is short. The ovejectors are joined by narrow, S-shaped ducts with the wide, opposed uterine branches. The eggs measure 0.105–0.12 × 0.05–0.066 mm.

5. Genus **UNCINARIA** Frölich, 1789.

Synonyms:—*Dochmius* Dujardin, 1845; *Dochmoides* Cameron, 1924.

Head bent slightly dorsally. Mouth-opening guarded by a pair of ventral cutting-plates. Buccal capsule large and funnel-shaped. Near its base a pair of subventral lancets. Dorsal cone within the wall of the capsule, not projecting into the lumen. Bursa with a short dorsal lobe and two large, separate lateral lobes. Antero-lateral rays rather divergent from the other lateral rays. Externo-dorsal rays originate

near the base of the dorsal ray. Dorsal ray cleft for about a quarter of its length; its terminations usually tridigitate. Spicules slender, not barbed. An accessory piece present. Vulva in the posterior half of the body. Adult worms in the intestine of mammals.

Genotype :—*Uncinaria criniformis* (Goeze, 1782)*.

Key to Species.

Spicules of male about 0·7 mm. long *stenocephala*, p. 337.
 Spicules of male about 1·2 mm. long *longespiculum*, p. 338.

1. *Uncinaria stenocephala* (Raill., 1884) Railliet, 1885.
 (Fig. 155.)

Synonyms :—*Strongylus criniformis* Rudolphi, 1802; *Strongylus trigonocephalus* of Gurlt, 1831, *nec* Rudolphi, 1808; *Dochmius trigonocephalus* Ercolani, 1859 (part); *Dochmius stenocephalus* Railliet, 1884; *Ankylostoma stenocephalum* Blanchard, 1888; *Ankylostomum stenocephalum* v. Linstow, 1889; *Ankylostoma trigonocephalum* Looss, 1898, *nec* Blanchard, 1888; *Uncinaria polaris* Looss, 1911; *Dochmoides stenocephala* Cameron, 1924; ? *Ascaris criniformis* Goeze, 1782.

Hosts :—This is a not uncommon parasite of the intestine of dogs, wolves and foxes in Europe and North America. It

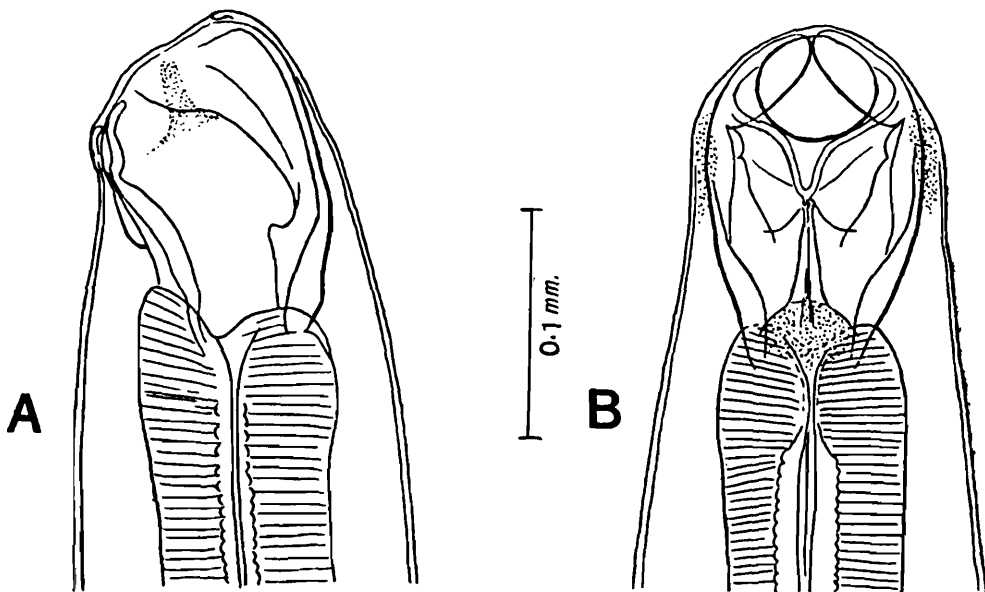

Fig. 155.—*Uncinaria stenocephala*. Anterior end. A, lateral view; B, dorsal view. (After Baylis, in 'Parasitology.')

occurs also in the European badger (*Meles meles*), and has been recorded from the pig in Canada. Gaiger records specimens from the dog in the collection of the Punjab Veterinary College.

* There is great uncertainty as to the identification of this species, but it seems not improbable that it is in reality identical with *U. stenocephala* (Raill., 1884).

The male measures about 5–8.5 mm. in length and 0.18 mm. in maximum thickness, the female about 7–12 mm. and 0.2 mm. respectively. The buccal capsule measures up to approximately 0.15 mm. in length and 0.1 mm. in dorso-ventral diameter. The subventral lancets are not very prominent. The œsophagus is about 0.5–0.85 mm. long. The cervical papillæ, nerve-ring and excretory pore are situated a little in front of the middle of the œsophagus.

Each branch of the dorsal ray of the bursa has three terminal digitations, of which the outermost is the longest. The spicules measure about 0.64–0.76 mm. in length, and have simple, sharp points.

The tail of the female is 0.15–0.29 mm. long, and has a small terminal spike. The vulva is situated at about the posterior third of the body. The eggs measure about 0.065–0.08 × 0.04–0.05 mm.

2. *Uncinaria longespiculum* Maplestone, 1931.

Synonym :—*Uncinaria philippinensis* Chitwood, 1932.

Hosts :—This species was recorded by Maplestone from the small intestine of a civet-cat (*Viverricula malaccensis*) in the Zoological Gardens, Calcutta. Chitwood's species was recorded from a Philippine civet (*Paradoxurus philippinensis*) in the National Zoological Park, Washington, U.S.A. The writer has had the opportunity of comparing paratypes of Chitwood's species with specimens determined by Maplestone as *U. longespiculum*, and has already (Baylis, 1933, *b*) expressed the view that the species are identical.

The male measures about 3.3 mm. in length and 0.18–0.24 mm. in maximum thickness, the female 3.3–4 mm. and 0.25–0.36 mm. respectively. The buccal capsule measures about 0.08–0.1 mm. in length and 0.06–0.09 mm. in width. "When viewed laterally the ventral wall of the capsule is seen to consist of three articulated plates, and articulations are also visible in the lateral walls of the capsule" (*Maplestone*). The duct of the dorsal œsophageal gland extends about half-way along the dorsal wall of the capsule. The subventral lancets are triangular and rather prominent. The œsophagus is about 0.42–0.5 mm. long. The nerve-ring is situated at 0.2–0.26 mm., and the excretory pore at 0.3–0.36 mm., from the anterior extremity.

The terminations of the branches of the dorsal ray of the bursa are tridigitate, the outermost digitation being the longest. The spicules are slender and measure 1.19–1.25 mm. in length. The accessory piece is about 0.07–0.09 mm. long.

The tail of the female is 0.1–0.25 mm. long, and is blunt at the tip, but provided with a hair-like terminal filament.

The vulva is situated a little behind the middle of the body. At the level of the vulva there is a conspicuous, asymmetrical, subventral papilla, which may be either on the left or on the right side. The eggs measure $0.06-0.066 \times 0.032-0.038$ mm.

6. Genus **TETRAGOMPHIUS** Baylis and Daubney, 1923.

Mouth guarded by slightly-developed ventral cutting-plates. Buccal capsule cup-shaped. At its base a pair of subdorsal and a pair of subventral lancets, the former bicuspid and the latter usually tricuspid. Dorsal cone represented by a blunt tubercle carrying the dorsal gutter. Bursa short and stunted. Dorsal ray stout, giving off the externo-dorsal rays a little in front of its bifurcation; the terminations of its branches bidigitate. Spicules very long and filiform, not barbed. Vulva in posterior half of body.

Genotype :—*Tetragomphius procyonis* Baylis and Daubney, 1923.

1. **Tetragomphius procyonis** Baylis and Daubney, 1923.
(Figs. 156–159.)

Host :—A raccoon (*Procyon* sp.); Zoological Gardens, Calcutta. The worms appeared to have been inhabiting

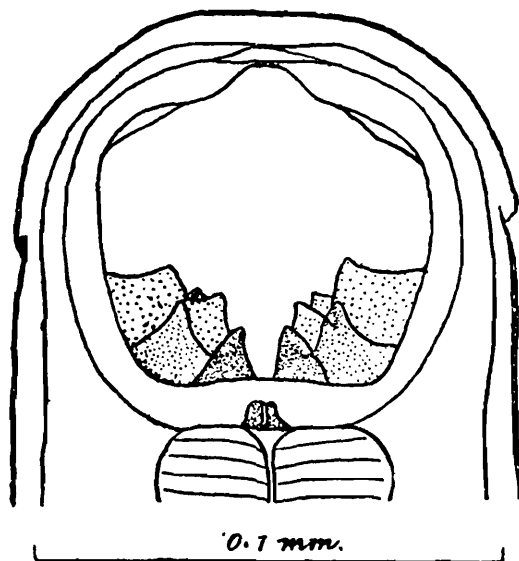

Fig. 156.—*Tetragomphius procyonis*. Anterior end; dorsal view.
(After Baylis and Daubney.)

galleries in the substance of a fibrous tumour of the pyloric end of the stomach.

The male measures 13–15 mm. in length and up to 0.46 mm. in maximum thickness, the female 16–20 mm. and up to 0.65 mm. respectively. There is a rather long, slender neck. The head is small and is bent dorsally. It measures about 0.14 mm. in diameter. The cusps of the subdorsal teeth are

Fig. 157.

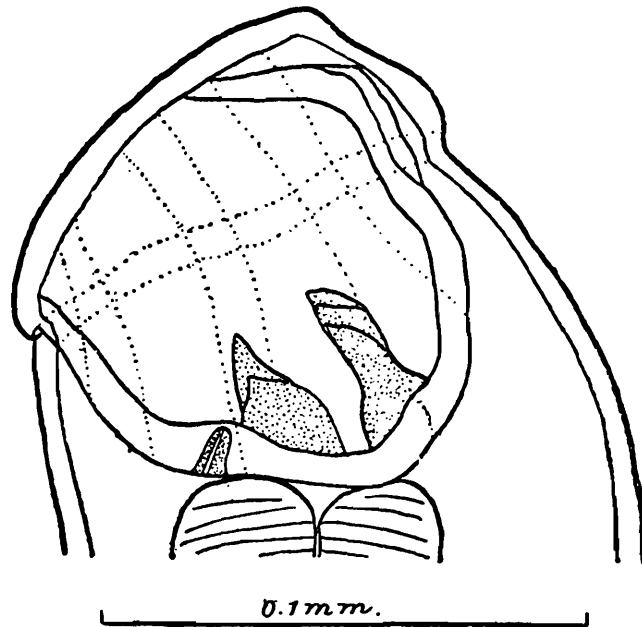

Fig. 158.

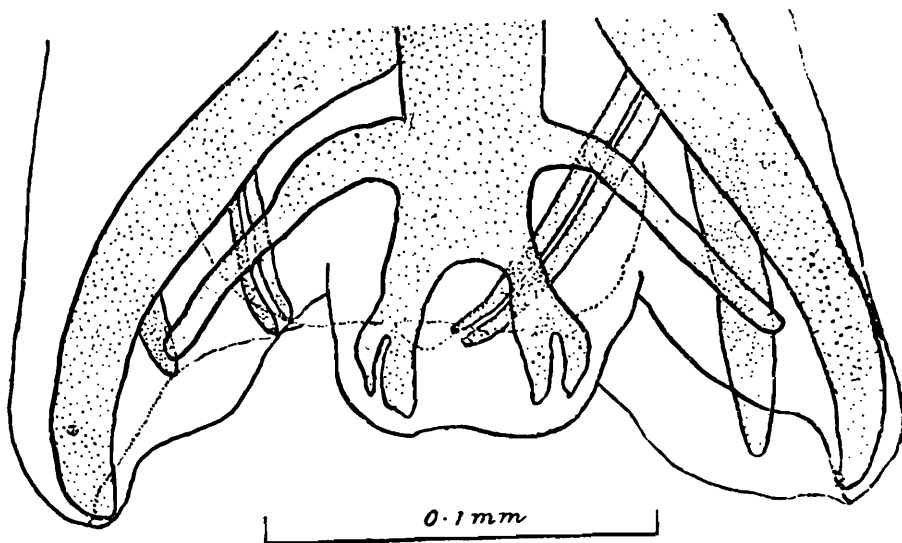

Fig. 159.

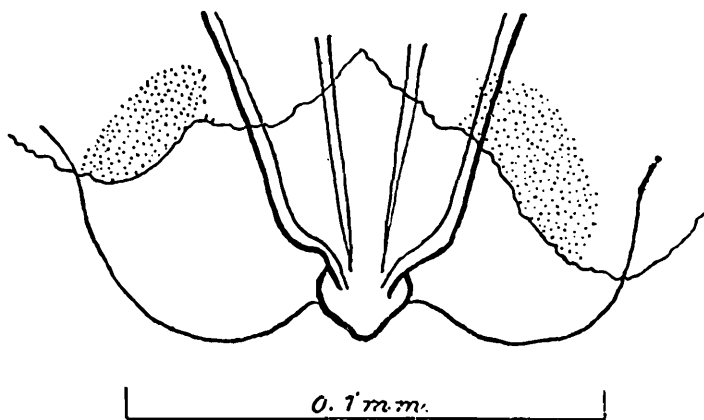

Fig. 157.—*Tetragomphius procyonis*. Anterior end; lateral view.
(After Baylis and Daubney.)

Fig. 158.—*Tetragomphius procyonis*. Bursa of male; dorsal view.
(After Baylis and Daubney.)

Fig. 159.—*Tetragomphius procyonis*. Genital cone; ventral view.
(After Baylis and Daubney.)

stout and conical, and measure 0·011–0·018 mm. in height. The subventral teeth are more slender structures, measuring about 0·043 mm. in height, and may appear bicuspid or tricuspoid. The dorsal gutter is carried by a blunt tubercle in the dorsal wall at the base of the capsule. The œsophagus is about 0·65 mm. long, and has a maximum thickness of about 0·13 mm. The cervical papillæ are situated at 0·6–0·7 mm. from the anterior end, and have the form of stout, backwardly-projecting spines.

The arrangement of the rays of the bursa is similar to that in *Uncinaria*. The genital cone is short and stout. The spicules measure 7–8 mm. in length, and end in fine points.

The tail of the female is about 0·34 mm. long, and is bluntly pointed. The vulva is situated at a distance of 3·6–4 mm. from the posterior extremity. Its opening is a transverse slit with fairly prominent lips. The vagina is short. The ovejectors are feebly muscular. They are opposed at their origin, but the posterior ovejector turns forward after a short course posteriorly, and both branches of the uterus are anterior. The eggs measure 0·076–0·082 × 0·045–0·05 mm., and their contents are segmenting when they are ready for laying.

7 Genus **GRAMMOCEPHALUS** Railliet and Henry, 1910.

Mouth-opening slightly tilted dorsally and guarded by a pair of ventral cutting-plates. Buccal capsule wide anteriorly and narrowed posteriorly, the narrowing being more abrupt on the dorsal side and accompanied by an infolding of the dorsal wall. At about the middle of the capsule a pair of lateral and a pair of subventral lancets, and a dorsal cone carrying the dorsal gutter. Intestine with a long, anteriorly-directed dorsal cæcum arising close to its union with the œsophagus. Externo-dorsal rays of bursa originate from the main stem of the dorsal ray immediately in front of its bifurcation. Terminations of dorsal ray bidigitate. Spicules stout, alate. No accessory piece. Vulva near the middle of the body. Adult forms parasitic in the bile-ducts of elephants and rhinoceroses.

Genotype:—*Grammocephalus clathratus* (Baird, 1868).

1. **Grammocephalus varedatus** Lane, 1921. (Figs. 160 & 161.)

Synonyms:—*Strongylus clathratus* Cobbold, 1882 (part); *Sclerostoma clathratum* Piana and Stazzi, 1900, *nec* Baird, 1868; *Grammocephalus clathratus* of Railliet and Henry, 1910.

Host:—Indian elephant (bile-ducts); obtained in India by Ware, and in Burma by Evans and Rennie. Specimens

in the British Museum (Natural History) from Madras and Burma.

The following description is taken from Lane. The male measures about 55 mm. in length and 1.35 mm. in maximum thickness, the female 47 mm. and 1.1 mm. respectively. The cuticular striations are at intervals of 14μ . The buccal capsule is 0.55 mm. long, the œsophagus 3.6 mm. and the intestinal cæcum 2.2 mm. The nerve-ring is situated at

Fig. 160.

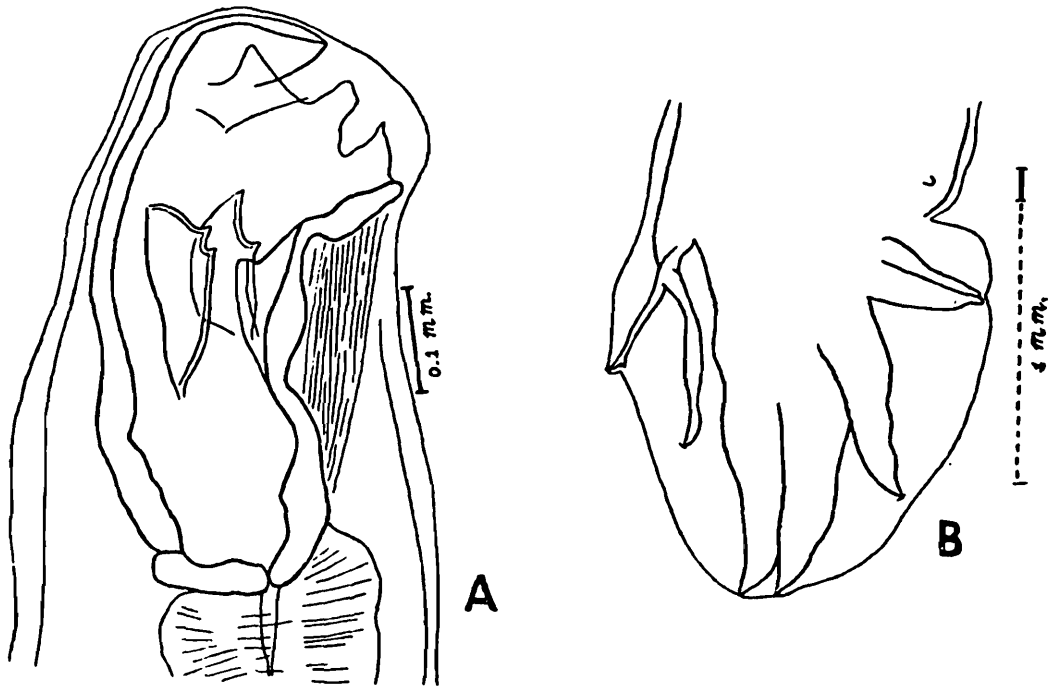

Fig. 161.

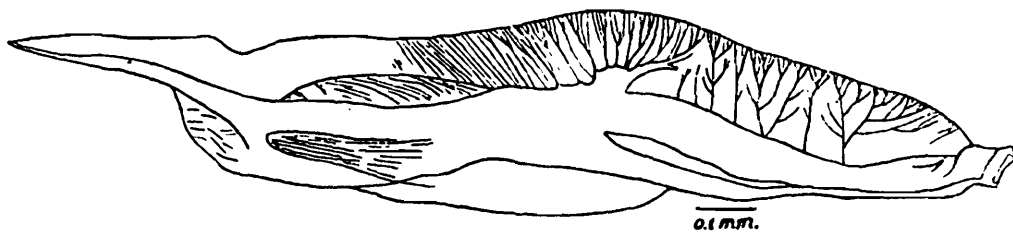

Fig. 160.—*Grammocephalus varedatus*. A, anterior end, lateral view; B, bursa of male, lateral view. (After Lane.)

Fig. 161.—*Grammocephalus varedatus*. Right spicule; dorsal view. (After Lane.)

1.16 mm., the excretory pore at 1.5 mm., and the cervical papillæ at 1.7 mm., from the anterior end.

The arrangement of the rays of the bursa is very similar to that in *Uncinaria*. A pair of prebursal papillæ is present. The spicules “are strong, with a massive central thickening and an ala on each side, that towards the midline being the larger and marked by a fine etching of delicate, dichotomously dendritic lines.” They measure 1.35 mm. in length.

The tail of the female is conical and 0.8 mm. long. The vulva is situated at 22 mm. from the anus. The vagina is very short and the ovejectors are opposed. The eggs measure 0.068×0.037 mm.

8. Genus **BATHMOSTOMUM** Railliet and Henry, 1909.

Anterior extremity bent dorsally. Mouth-opening guarded by a pair of ventral cutting-plates. Buccal capsule fissured on its dorsal and lateral aspects; its internal surface raised, chiefly ventrally and laterally, into shelf-like projections encroaching on the cavity. One of these is produced into a pair of subventral teeth. A small dorsal tooth surmounts the dorsal column of the œsophagus. Externo-dorsal rays of bursa originate from the branches of the dorsal ray. The latter is cleft for almost the whole of its length. Spicules stout. Accessory piece absent. Vulva near the middle of the body. Adult worms parasitic in the alimentary tract of elephants.

Genotype :—*Bathmostomum sangeri* (Cobbold, 1879).

1. **Bathmostomum sangeri** (Cobbold, 1879) Railliet and Henry, 1909.

Synonyms :—*Dochmius sangeri* Cobbold, 1879; *Uncinaria sangeri* Railliet, 1897; *Uncinaria os-papillatum* Piana, in Piana and Stazzi, 1900.

Host :—Indian elephant (cæcum); obtained in India by Lane, and recorded from Burma by Gaiger.

The male measures about 15–16 mm. in length, the female 16–20 mm. The cuticular striations are at intervals of 5μ . The buccal capsule is wider than it is long. Its length is about 0.24 mm. Its ventral and lateral surfaces internally are crossed by three transverse “shelves,” the posterior of which “appears to encircle the whole base of the oral cavity” (*Lane*), and is produced into a pair of subventral teeth. The œsophagus is about 1.5 mm. long. The nerve-ring is situated at 0.5 mm., the excretory pore at 0.6 mm., and the cervical papillæ at 0.66 mm., from the anterior extremity.

The spicules are about 0.47 mm. long. They are “thickened, first dorsally, then ventrally, the latter portion passing on into the very sharp, truncated point” (*Lane*).

The tail of the female is 0.6 mm. long, and has the form of an elongate cone, with a terminal spike. The vulva is situated at a distance of about 9 mm. from the anus. The vagina is short, and the opposed uterine branches have powerful ovejectors. The eggs measure about 0.045×0.03 mm.

14. Family DIAPHANOCEPHALIDÆ Travassos, 1919.

Head laterally compressed. A rudimentary leaf-crown may be present or absent. Mouth-opening a dorso-ventral slit, facing anteriorly or somewhat inclined towards the dorsal side. Walls of buccal capsule valve-like, each lateral wall supported by three external longitudinal parenchymatous bands which terminate as cephalic papillæ, and by one or two internal transverse ridges. A dorsal and a ventral cuticular pad present towards the base of the buccal capsule. Oviparous. Parasitic in the alimentary tract of reptiles.

1. Genus **KALICEPHALUS** Molin, 1861.

Synonym :—*Occipitodontus* Ortlepp, 1923.

A rudimentary leaf-crown may be present or absent. Valves of buccal capsule supported by a single internal transverse chitinous ridge, which is V-shaped dorsally and ventrally. Œsophageal funnel occasionally contains three small teeth. There is no dorsal hump in front of the bursa of the male. Bursa well developed, entire. Ventral rays closely apposed, sometimes fused for a considerable portion of their length. Lateral rays usually well separated, the antero-dorsal ray commonly rather shorter than the others. Externo-dorsal rays originate from the main stem of the dorsal ray, usually rather near its base. The dorsal ray also gives off a pair of accessory branches, usually near its bifurcation. Its terminal branches rather short and bidigitate. Spicules slender, generally equal. An accessory piece usually present. Genital cone usually not projecting beyond the margin of the bursa. Vulva in posterior half of body. Uterine branches opposed or parallel. Adult worms in the alimentary tract of snakes and lizards.

Genotype :—*Kalicephalus mucronatus* Molin, 1861.

It seems at present almost impossible to construct a satisfactory key to the Indian species of this genus, owing to the great amount of variation and overlapping in their measurements, and the great uniformity of their morphological characters. *K. fimbriatus* can be recognized by the presence of a rudimentary leaf-crown within the border of the mouth, and of three small teeth at the base of the buccal capsule. *K. minutus* is readily separated from other species by the marked

inequality in length of the spicules of the male, and by the form of the dorsal ray of the bursa. For the separation of the other species the sum of all their characters must be taken into consideration.

1. *Kalicephalus willeyi* v. Linstow, 1904. (Figs. 162 & 163.)

Synonym :—*Diaphanocephalus willeyi* Railliet and Henry, 1909, nec Baylis and Daubney, 1922, nec Daubney, 1923.

Host :—Russell's viper (*Vipera russellii*) (oesophagus, stomach and intestine). This species was originally recorded by v. Linstow from this host at Colombo and Weligatta, Ceylon. At the same time he recorded it from *Coluber helena* at Horana, Ceylon, and later from *Typhlops braminus* and *Bungarus fasciatus*. Baylis and Daubney (1922) recorded specimens which are considered to be of this species from Russell's viper, under the name of *Diaphanocephalus* sp.*, and Maplestone (1931) has also recorded specimens from the same host, in the Zoological Gardens, Calcutta. The occurrence of *K. willeyi* in hosts other than *Vipera russellii* at present lacks confirmation, and it is probable, as Ortlepp (1923) has pointed out, that the specimens recorded by v. Linstow from other hosts belonged to different species.

v. Linstow's original description is very inadequate, and in several respects inaccurate. Through the courtesy of the Director of the Colombo Museum, the writer has had the opportunity of examining some of the original specimens from *Vipera russellii*. According to v. Linstow there was a single male, measuring 5.9 mm. in length and 0.33 mm. in thickness, among a large number of females, which measured up to 19 mm. in length and 0.51 mm. in thickness. In the material seen by the writer no male was found, and the largest female measured was only 11.8 mm. long. Other observers (Baylis and Daubney, 1922; Ortlepp, 1923; Maplestone, 1931) have failed to find males, but females have been recorded measuring up to 18 mm. (Baylis and Daubney) or even 19.7 mm. (Maplestone) in length. The writer has recently received from Prof. B. K. Das two sets of specimens obtained from Russell's vipers at Hyderabad, Deccan. Among numerous females, one set contained three males which were apparently mature, the other set two immature males measuring only 6.3 mm. and 7 mm. in length. This material is considered to be of the same species as v. Linstow's and subsequent authors' specimens.

* The *Diaphanocephalus willeyi* of Baylis and Daubney, 1922, and of Daubney, 1923, is *K. fimbriatus*.

K. willeyi appears to be a form which varies very considerably in size. The following description is based partly on v. Linstow's types, partly on the descriptions given by Baylis and Daubney and by Maplestone, and partly on the material from Hyderabad.

The mature male measures 8.4–10 mm. in length and 0.2–0.23 mm. in maximum thickness, the female 6.9–19.7 mm.

Fig. 162.

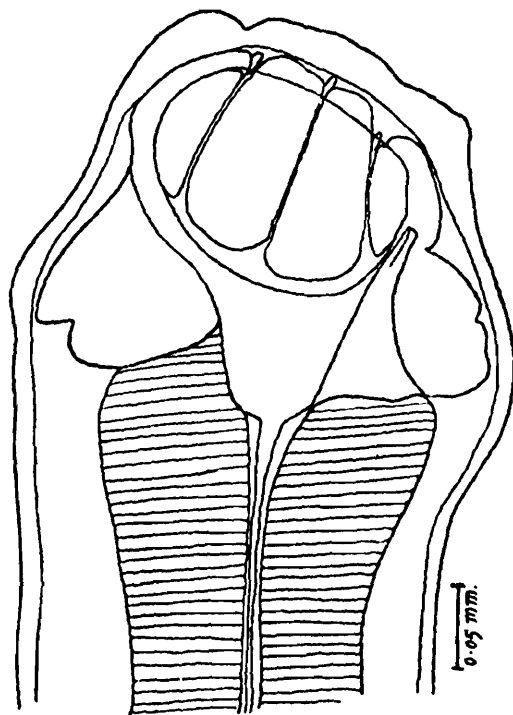

Fig. 163.

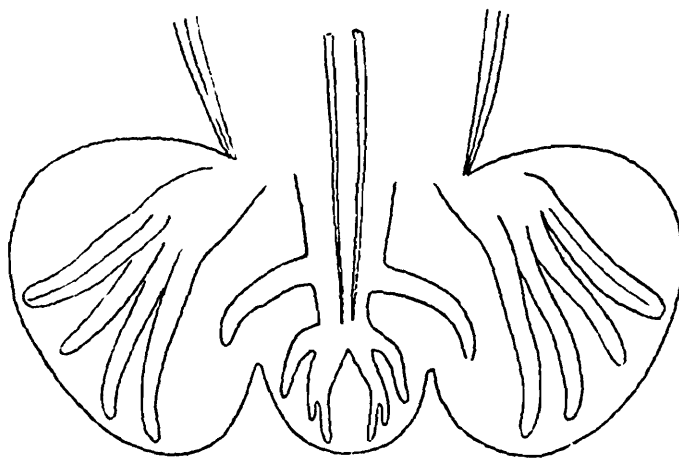

Fig. 162.—*Kalicephalus willeyi*. Anterior end; lateral view. (After Maplestone.)

Fig. 163.—*Kalicephalus willeyi*. Bursa of male. (After v. Linstow.)

and 0.25–0.59 mm. respectively. The dorso-ventral diameter of the head at its widest part (*i. e.* at about the level of the posterior end of the buccal capsule) is 0.17–0.317 mm. The mouth is, in some specimens, tilted a little towards the dorsal side, but seldom to the extent indicated by Maplestone (1931)

in his figure—in the majority of specimens it is directed almost straight forward. The length of the buccal capsule is 0.13–0.15 mm. in the male, 0.14–0.228 mm. in the female. The absolute length of the œsophagus is 0.33–0.35 mm. in the male, 0.34–0.515 mm. in the female, and its maximum thickness varies between 0.13 mm. and 0.277 mm. The nerve-ring is situated at about 0.24–0.35 mm., and the excretory pore at about 0.34–0.4 mm., from the anterior extremity.

The bursa of the male is typical. v. Linstow's figure (fig. 163), though very diagrammatic, gives a fairly good representation of the form of the dorsal ray. The spicules are very slender, except near their roots, and measure about 0.32 mm. in length (0.37 mm., according to v. Linstow). There is a long, slender accessory piece.

The tail of the female is conical and shows great variation in length (0.33–0.85 mm.) according to the size of the specimen. The vulva is situated, usually on a prominent papilliform process, at a distance of 2.3–7.7 mm. from the posterior end, dividing the total length in the ratio of about 1.5 : 1 or 2 : 1 (v. Linstow's figure 18 : 5 appears to be erroneous). The eggs *in utero* are much larger than is stated by v. Linstow, measuring on the average about 0.076 × 0.044 mm.

2. *Kalicephalus indicus* Ortlepp, 1923.

Synonyms :—*Kalicephalus bengalensis* Maplestone, 1929; *Kalicephalus parvus* Maplestone, 1932, *nec* Ortlepp, 1923; *Kalicephalus maplestonei* Chatterji, 1935.

Hosts :—*Kalicephalus indicus* was originally recorded by Ortlepp from the stomach and duodenum of the Indian rat-snake (*Ptyas* [*Zamenis*] *mucosus*) and *Tropidonotus piscator* in the Zoological Gardens, London. Maplestone (1929, *a*) described *K. bengalensis* from the former host in the Zoological Gardens, Calcutta, but later (1931) recognized it as a synonym of *K. indicus*, which he recorded from several additional hosts—the green snake (*Dryophis mycterizans*), the cobra (*Naja tripudians*), the king cobra (*Naja hannah* [*N. bungarus*]), the common Indian monitor (*Varanus monitor* [*V. bengalensis*]) and a “wild cat.” It was assumed that the last was not a true host, but had recently devoured a snake that harboured the worm. In 1932 Maplestone described a further species, under the preoccupied name of *K. parvus*, from the intestine of the cobra. All these records were from the Zoological Gardens, Calcutta. The writer has compared Maplestone's description of *K. parvus* with the existing descriptions of *K. indicus* and with co-types of the latter species which are in the collection of the British Museum (Natural History), and is of the opinion that the species are identical. Maple-

stone's material of *K. parvus* consisted of three males only, which seem to have been rather small and were, perhaps, immature.

The male measures 4.2–6.2 mm. in length (or 3.2–3.6 mm. in *K. parvus*) and 0.188–0.32 mm. in maximum thickness, the female 6.4–9.2 mm. and 0.32–0.39 mm. respectively. The mouth is directed straight forward. The dorso-ventral diameter of the head, at its widest part, is about 0.15–0.17 mm. in the male. The length of the buccal capsule is about 0.108–0.16 mm. The duct of the dorsal œsophageal gland extends for barely more than half the length of the capsule. "At its junction with the œsophagus the buccal capsule is reinforced by triangular plates and transverse bars of chitin" (*Maplestone*). The œsophagus is about 0.24–0.27 mm. long, and has a maximum thickness of about 0.12–0.19 mm. The cervical papillæ are small and situated at nearly 0.3 mm. from the anterior extremity. The nerve-ring is situated at 0.07–0.1 mm., and the excretory pore at 0.14–0.29 mm., from the anterior end of the œsophagus.

The genital cone of the male is about 0.06 mm. long. The spicules measure 0.32–0.47 mm. in length, and are alate. The accessory piece is 0.12–0.13 mm. long (0.08 mm. in *K. parvus*).

The tail of the female is 0.138–0.198 mm. long, and ends in a sharp cuticular spike. The body narrows abruptly behind the vulva, which is usually prominent and is situated at 0.99–1.9 mm. from the posterior extremity (*i. e.* at about the posterior fifth or quarter of the body). The posterior uterine branch usually runs posteriorly for a distance of 0.2–0.5 mm. from the vulva and then turns forward. The eggs measure 0.055–0.08 × 0.027–0.04 mm.

3. *Kalicephalus longior* Maplestone, 1931.

Synonyms:—*Kalicephalus gongylophus* Maplestone, 1931; *Kalicephalus radicus* Bhalerao, 1931.

Hosts:—*Kalicephalus longior* is recorded by Maplestone from the intestine of the cobra (*Naja tripudians*) and of the banded krait (*Bungarus fasciatus*). In the same paper Maplestone records *K. gongylophus* from the intestine of a sand-snake (*Gongylophus conicus*). All these records are from the Zoological Gardens, Calcutta, and in each case female worms only were found. Bhalerao (1931) records *K. radicus* from the intestine and rectum of the king cobra (*Naja hannah*) at Muktesar, and describes both sexes of the worm. The writer has had the opportunity of comparing co-type specimens of *K. longior* with specimens determined by Dr. Maplestone as *K. gongylophus*, and is of the opinion that these two

species are identical. Further, the extremely close agreement in structure and measurements of the female of *K. radicus*, as described by Bhalerao, leaves little room for doubt that this species also is identical with *K. longior*. The latter name has priority, Maplestone's paper having been published in the month previous to Bhalerao's. The writer (1933, *a*) has recorded, under the name of *K. radicus*, specimens which probably belong to the same species from *Elaphe flavolineata* in the Federated Malay States.

The male (*K. radicus*) measures 6.67–7.32 mm. in length and 0.27–0.285 mm. in maximum thickness. The female varies in length from about 7.48 to 12 mm., and in thickness from about 0.33 to 0.5 mm. (Maplestone gives 0.436–0.495 mm. for *K. gongylophis*, but the writer found 0.33–0.35 mm. in the specimens of that form examined). The mouth may be directed straight forwards or somewhat tilted dorsally. The dorso-ventral diameter of the head, at the widest part, is about 0.1 mm. in the male, 0.17–0.237 mm. in the female. The length of the buccal capsule is 0.11 mm. in the male, 0.12–0.18 mm. in the female. The œsophagus is 0.28–0.44 mm. long, and has a maximum diameter of 0.13–0.225 mm. The nerve-ring is situated at 0.111–0.118 mm., and the excretory pore at 0.23–0.25 mm., from the anterior end of the œsophagus.

The dorsal ray of the bursa is of the normal type. The genital cone is well developed and measures 0.117 mm. in length. The spicules are 0.282–0.295 mm. long, according to Bhalerao. In the writer's material from *Elaphe* they measured 0.26–0.31 mm. The accessory piece is 0.111–0.125 mm. long (Bhalerao), and is in the form of "a slender rod, slightly swollen in the centre."

The tail of the female is tapering and has a rather blunt tip. It measures about 0.34–0.49 mm. in length. The vulva is fairly prominent and is situated at 2.65–4.7 mm. from the posterior end, dividing the total length in the ratio of about 1.5 : 1 or 2 : 1. The vagina is short. Muscular ovejectors are present. (Maplestone states that these are absent in *K. longior*, but the writer found them to be present in a co-type specimen). The eggs, according to Maplestone, measure 0.076–0.08 × 0.04–0.044 mm. Bhalerao gives their dimensions in *K. radicus* as 0.044–0.08 × 0.034–0.053 mm.

4. *Kalicephalus elongatus* Maplestone, 1931.

Hosts :—Rat-snake (*Ptyas* [*Zamenis*] *mucosus*) and cobra (*Naja tripudians*) (intestine); Zoological Gardens, Calcutta.

The male measures 7.8–8 mm. in length and about 0.28–0.3 mm. in maximum thickness, the female 10.9–12.7 mm.

and about 0.36–0.43 mm. respectively. A cuticular swelling, more pronounced dorsally and ventrally than laterally, extends from the level of the middle of the buccal capsule to about that of the posterior end of the œsophagus. The greatest dorso-ventral diameter of the head is 0.237 mm. in the male, 0.277–0.317 mm. in the female. The buccal capsule has a length of 0.1–0.108 mm. in the male, 0.128–0.14 mm. in the female. The œsophagus is about 0.29–0.3 mm. long in the male and 0.34–0.36 mm. in the female, and has a maximum diameter of 0.12–0.17 mm. The nerve-ring is situated at 0.088–0.124 mm., and the excretory pore at 0.208–0.24 mm., from the anterior end of the œsophagus.

The genital cone of the male is relatively long (0.2 mm.) There are small, rounded prominences at the bases of the externo-dorsal rays of the bursa. The spicules measure about 0.42–0.44 mm. in length, the accessory piece 0.14–0.15 mm.

The tail of the female is sharply pointed and about 0.61–0.67 mm. long. The vulva is situated on a very prominent papilla at 2–2.65 mm. from the posterior end (*i. e.* at about the posterior fifth of the body). The eggs measure 0.068 × 0.044 mm.

5. *Kalicephalus brachycephalus* Maplestone, 1931.

Host :—Rat-snake (*Ptyas* [*Zamenis*] *mucosus*) (intestine); Zoological Gardens, Calcutta.

The male measures about 7.2 mm. in length and 0.34 mm. in maximum thickness, the female 9.2–10.4 mm. and 0.36 mm. respectively. The head is considerably wider than the neck. Its greatest dorso-ventral diameter is about 0.38 mm. in the male and 0.45–0.51 mm. in the female. The buccal capsule has a length of about 0.3 mm. in the male and 0.4–0.5 mm. in the female. The œsophagus measures, in the male, about 0.51 mm. in length and 0.24 mm. in maximum diameter; in the female about 0.61–0.65 mm. and 0.28 mm. respectively. The nerve-ring is situated at 0.12–0.15 mm., and the excretory pore at 0.18–0.25 mm., from the anterior end of the œsophagus.

The genital cone of the male is a rounded eminence surrounded by a cuticular inflation, and measures 0.1 mm. in length. The dorsal ray of the bursa is stout, but has slender branches. The ventral rays are separate for nearly the whole of their length. The spicules are 0.4 mm. long, the accessory piece 0.16 mm. “The dorsal and ventral walls of the spicule canal are chitinized, and in addition there is a slightly curved chitinous structure in the genital cone, which is V-shaped on ventral view” (*Maplestone*).

The tail of the female is conical and about 0.32 mm. long. The vulva is slightly prominent and situated at about

3-3.4 mm. from the posterior end, dividing the total length in the ratio of about 2 : 1. The vagina is short. The eggs measure 0.076×0.06 mm.

6. **Kalicephalus minutus** (Baylis and Daubney, 1922) Ortlepp, 1923. (Figs. 164-166.)

Synonyms :—*Diaphanocephalus minutus* Baylis and Daubney, 1922 ; *Kalicephalus naiæ* Maplestone, 1931.

Hosts :—Cobra (*Naja tripudians*) and banded krait (*Bungarus fasciatus*) ; Zoological Gardens, Calcutta.

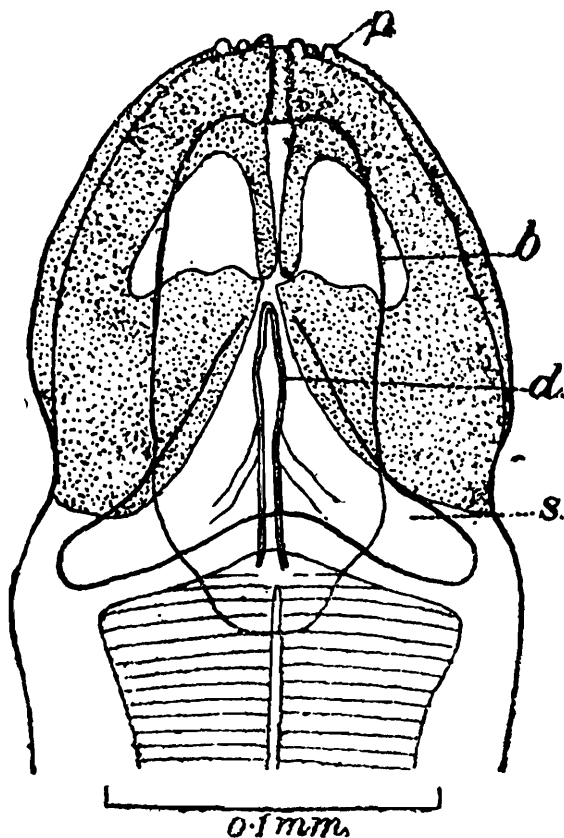

Fig. 164.—*Kalicephalus minutus*. Anterior end of female ; dorsal view. *b.*, wall of buccal capsule ; *d.*, duct of dorsal oesophageal gland ; *p.*, papilla ; *s.*, wall of buccal capsule (optical section). (After Baylis and Daubney.)

Maplestone (1931) has drawn attention to the similarity between his species *K. naiæ* and the previously-described *K. minutus*, but pointed out certain features in which his material did not agree with the description of the latter. The writer has re-examined co-type specimens of *K. minutus* in the collection of the British Museum (Natural History), and compared them with co-types of *K. naiæ*, and finds that in the points referred to all the material agrees with Maplestone's description. The distinction between the species therefore disappears, and *K. naiæ* falls into synonymy.

The male measures 4.5–5.4 mm. in length and about 0.2–0.25 mm. in maximum thickness, the female 4.5–6.2 mm. and about 0.21–0.3 mm. respectively. The head is relatively wide, and is followed by a constriction. Its greatest dorso-ventral diameter is 0.2–0.24 mm. The buccal capsule has thick walls and measures about 0.16–0.22 mm. in length. The duct of the dorsal œsophageal gland extends for more

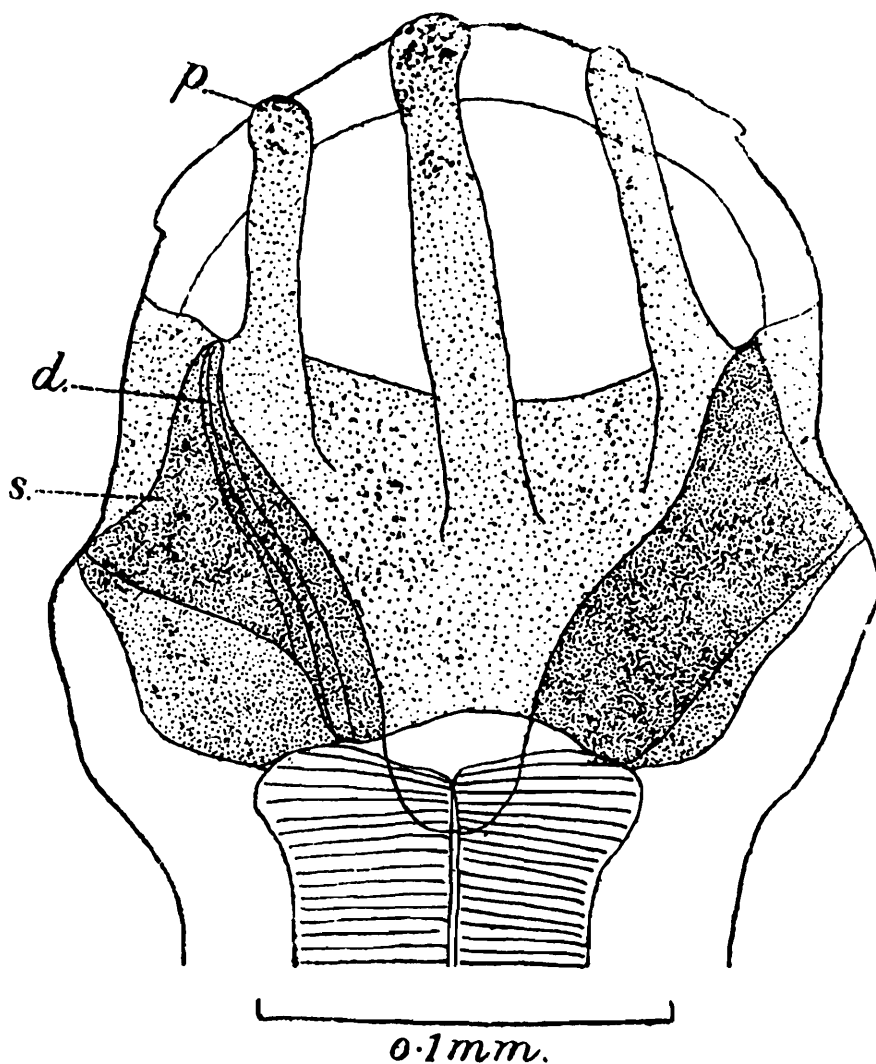

Fig. 165.—*Kalicephalus minutus*. Anterior end of female; lateral view. *d.*, duct of dorsal œsophageal gland; *p.*, papilla; *s.*, wall of buccal capsule (optical section). (After Baylis and Daubney.)

than half its length. The œsophagus is about 0.45–0.55 mm. long, and has a maximum diameter of about 0.15–0.2 mm. The nerve-ring is situated at about 0.09–0.18 mm., and the excretory pore at 0.38–0.44 mm., from the anterior end of the œsophagus.

The dorsal ray of the bursa is stout at its base. The externo-dorsal rays originate near its base, and almost immediately behind them a pair of accessory branches which are

long, stout and curved. The terminal branches of the dorsal ray are short and bidigitate. The ventral rays are long, slender, closely apposed and fused for about two-thirds of their length. The statement of Baylis and Daubney that the spicules are equal appears to have been erroneous. They are distinctly unequal in length, the longer measuring about 0.4–0.5 mm., the shorter about 0.32–0.33 mm. The latter is curved dorsally near the tip, and the concavity of the curve bears a membranous ala. There is a prominent genital cone, measuring about 0.1 mm. in length. Contrary to the statement of Baylis and

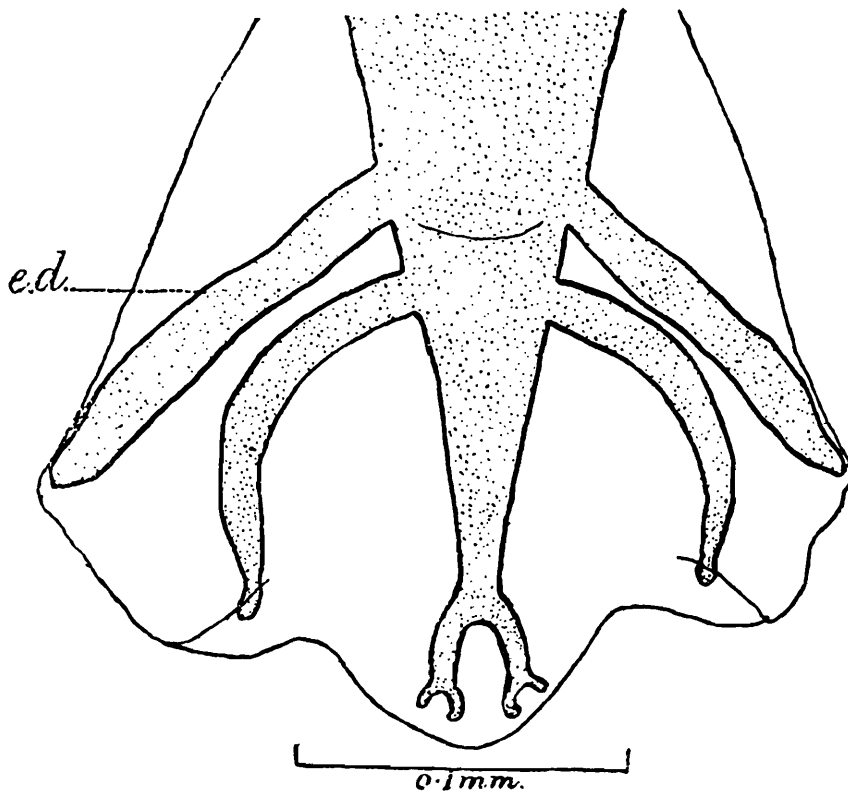

Fig. 166.—*Kalicephalus minutus*. Dorsal lobe of bursa of male; dorsal view. *e.d.*, externo-dorsal ray. (After Baylis and Daubney.)

Daubney, the dorsal wall of the spicular canal is chitinized, forming an accessory piece about 0.12 mm. long.

The tail of the female has a rather blunt tip, and measures about 0.22–0.3 mm. in length. The vulva is fairly prominent, and is situated at 1.3–1.8 mm. from the posterior end, dividing the total length in the ratio of about 2.2 : 1 or 2.5 : 1. The vagina runs slightly forward and is about 0.14 mm. long. The ovejectors, which have subglobular sphincters, have a combined length of about 0.3 mm. (not 0.45–0.5 mm., as stated by Baylis and Daubney). The eggs measure 0.068–0.08 × 0.031–0.04 mm.

7. *Kalicephalus fimbriatus* (Ortlepp, 1923). (Fig. 167.)

Synonyms :—*Kalicephalus willeyi* of v. Linstow, 1908, *nec* 1904 ;
Diaphanocephalus willeyi of Baylis and Daubney, 1922, and
 Daubney, 1923 ; *Occipitodontus fimbriatus* Ortlepp, 1923.

Host :—Banded krait (*Bungarus fasciatus*) (stomach and duodenum) ; recorded from the Zoological Gardens, Calcutta, by Baylis and Daubney and by Maplestone. The specimens recorded as *K. willeyi* by v. Linstow (1908) from *B. fasciatus* at Dibrugarh, Assam, probably also belonged to this species.

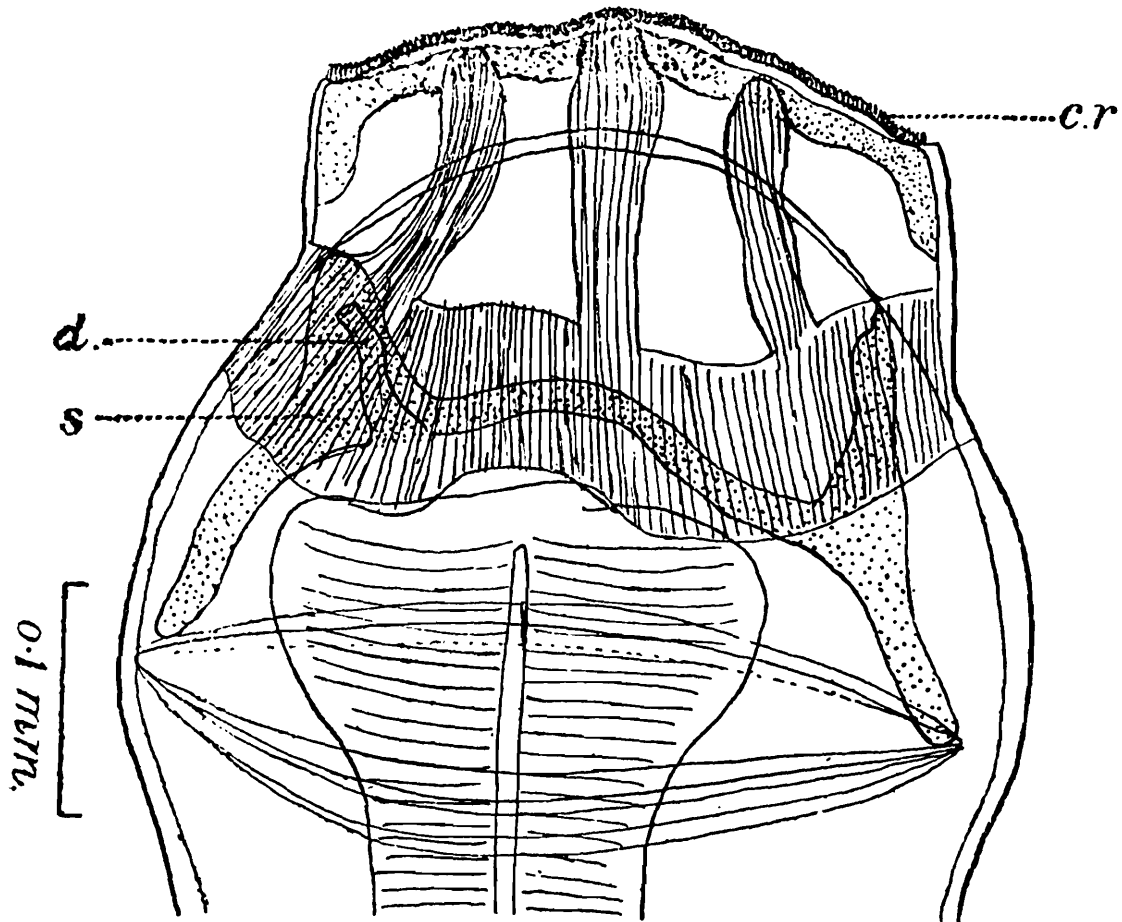

Fig. 167.—*Kalicephalus fimbriatus*. Anterior end of female ; lateral view. *c.r.*, corona radiata ; *d.*, duct of dorsal cesophageal gland ; *s.*, wall of buccal capsule (optical section). (After Baylis and Daubney.)

The male measures about 9.7–12.2 mm. in length and about 0.35–0.44 mm. in maximum thickness, the female 12.3–17.3 mm. and 0.5–0.6 mm. respectively. The head, in lateral view, is broad and abruptly truncate. The mouth is directed straight forward, and is a dorso-ventral slit bordered by an elliptical cuticular flap. On the inner surface of its edges there is a rudimentary leaf-crown. The dorso-ventral diameter of the head, at its widest part, is about 0.43–0.59 mm. The buccal capsule measures about 0.22–0.3 mm. in length. Its walls are very stout dorsally and ventrally, and are prolonged

posteriorly in the dorsal and ventral lines into processes which project outwards at an angle of about 45° from the main axis of the body. These processes, according to Daubney, "give attachment to elliptical muscle fibres which encircle the œsophagus. Contraction of these fibres would appear to close the mouth opening by lengthening its dorsoventral axis, thus pulling the edges into apposition, while relaxation would allow the mouth to open." Three small, pointed and forwardly-directed teeth (one dorsal and two subventral) are present at the base of the buccal capsule, where it passes into the lining of the œsophagus. The duct of the dorsal œsophageal gland extends forward for less than half the length of the capsule. The œsophagus measures 0.75–1.1 mm. in length, and has a maximum thickness of about 0.24–0.3 mm. The excretory pore and nerve-ring are situated at about 0.22–0.26 mm. from the anterior end of the œsophagus. The cervical papillæ are inconspicuous and are situated a little behind the middle of the œsophagus.

The genital cone of the male is prominent and measures 0.07–0.1 mm. in length. The spicules are slender and tapering, slightly alate, and spirally twisted near their tips. They measure about 0.43–0.49 mm. in length. The dorsal wall of the spicular canal is partly chitinized, but there is no distinct accessory piece.

The tail of the female is acutely conical and measures about 0.37–0.42 mm. in length. The vulva is situated approximately at the posterior third of the body, dividing the total length in the ratio of about 1.7 : 1 to 2.1 : 1. The anterior uterine branch extends to within 3–3.5 mm. of the posterior end of the œsophagus, the posterior branch almost to the level of the anus. The eggs measure $0.055\text{--}0.07 \times 0.035\text{--}0.045$ mm.

8. **Kalicephalus ersiliae** (Stossich, 1896) Yorke and Maplestone, 1926.

Synonyms :—*Strongylus ersiliae* Stossich, 1896; *Sclerostomum ersiliae* Stossich, 1899; *Diaphanocephalus ersiliae* Railliet and Henry, 1909.

Host :—This species is recorded by Stossich from *Python molurus* in the "East Indies."

The male is undescribed. The female is 9 mm. long. The body is slender, but thickened anteriorly. The vulva is situated at about the middle of the body, and has two prominent lips. The vagina is very short. The uterine branches are opposed, and each has a well-developed ovejector.

Stossich's description is not sufficient to enable the species to be identified. *K. ersiliae* seems, however, to be the only species recorded from a python.

9. *Kalicephalus* sp.

Synonym :—*Diaphanocephalus* sp. Baylis and Daubney, 1922.

Baylis and Daubney (1922) record from the cobra (*Naja tripudians*) a female specimen which it seems impossible to assign to any of the species described above. This measured 15.5 mm. in length and 0.43 mm. in thickness. The head was laterally compressed and had a dorso-ventral diameter of 0.27 mm. and a structure similar to that in *K. minutus*. The buccal capsule was 0.19 mm. deep. The œsophagus measured 0.485 mm. in length and 0.16 mm. in thickness. The tail was acutely pointed and 0.45 mm. long. The vulva was situated behind the middle of the body, dividing the total length in the ratio of 6 : 5, and its lips formed a papilliform outgrowth measuring 0.141 × 0.08 mm. The eggs measured 0.065 × 0.045 mm.

15. Family AMIDOSTOMIDÆ Baylis and Daubney, 1926.

Buccal capsule relatively shallow and broad, without teeth, cutting-plates or leaf-crowns at its anterior margin. Œsophagus typically with three axial chitinoid plates internally. Spicules of male relatively short, bifurcate or trifurcate distally. Vulva in the posterior half of the body.

Key to Genera.

Head with prominent backwardly-directed spines or "epaulettes"; buccal cavity reduced or absent	[p. 360. EPOMIDIOSTOMUM,
Head without prominent projections; a buccal capsule present	1.
1. Buccal capsule with one tooth or three teeth at its base; an accessory piece present in male	AMIDOSTOMUM, p. 356.
Buccal capsule without teeth; male without accessory piece	[p. 359. PSEUDAMIDOSTOMUM,

1. Genus **AMIDOSTOMUM** Railliet and Henry, 1909.

Buccal capsule wide, with one or three teeth at its base. Œsophagus with three axial chitinoid plates extending throughout its whole length or as far as the posterior swelling. Bursa with long lateral lobes and a short dorsal lobe. Ventro-ventral and latero-ventral rays widely divergent.

Antero-lateral and externo-dorsal rays short, not reaching the margin of the bursa. Externo-dorsal rays may arise separately from the dorsal ray or originate from its base. Dorsal ray cleft for a short distance only, and with bidigitate terminations. A pair of prominent papillæ present on the posterior lip of the cloacal aperture. Prebursal papillæ also present. Each spicule divided for the greater part of its length into two branches. An accessory piece present. Tail of female long and finger-shaped. Uterine branches opposed. Adult worms parasitic in the gizzard of ducks and other birds, under the horny lining.

Genotype :—*Amidostomum nodulosum* (Rud., 1803).

1. *Amidostomum skrjabini* Boulenger, 1926. (Fig. 168.)

Synonyms :—*Amidostomum fuligulæ* Maplestone, 1930 ; ? *Amidostomum anatinum* Sugimoto, 1928.

Hosts :—*A. skrjabini* was originally described by Boulenger from *Anser albifrons*, the specimens having probably been collected in Egypt. Maplestone (1930, *b*) records *A. fuligulæ* from the golden-eyed pochard (*Nyroca fuligula* [*Fuligula cristata*]), *Nyroca* [*Aythya*] *ferina* and several unidentified ducks in the Zoological Gardens, Calcutta. The present writer (1932) has examined specimens determined by Maplestone as *A. fuligulæ* from a garganey teal, also from the Zoological Gardens, Calcutta, and found them to agree with Boulenger's original material of *A. skrjabini*. This form was at the same time recorded from various species of ducks in Europe and Patagonia. *A. anatinum* Sugimoto, from the domestic duck in Formosa, appears to be indistinguishable from *A. skrjabini*. This species appears, therefore, to occur in a considerable number of Anseriform birds and to have a wide geographical distribution.

The male measures about 7.5–9 mm. in length and 0.1–0.13 mm. in maximum thickness, the female about 9–13.5 mm. and 0.1–0.14 mm. respectively. The cuticle is transversely striated. The buccal capsule has rather thin walls, and measures about 0.008–0.01 mm. in length and 0.011–0.017 mm. in width. It contains three teeth, a dorsal tooth which is long and pointed, and extends almost to the anterior margin of the capsule, and two very small and inconspicuous subventral teeth. The œsophagus is 0.55–0.78 mm. long. The nerve-ring is situated at 0.23–0.28 mm., the cervical papillæ at 0.3–0.42 mm., and the excretory pore at about 0.31 mm., from the anterior extremity.

The antero-lateral ray of the bursa is turned slightly forward, away from the medio-lateral ray. The externo-dorsal rays

are independent of the dorsal ray and terminate at a considerable distance from the edge of the bursa. The spicules measure about 0.12–0.16 mm. in length, and each ends in two unequal processes, the inner shorter and more pointed than the outer. The accessory piece is elongate and measures 0.06–0.08 mm. in length.

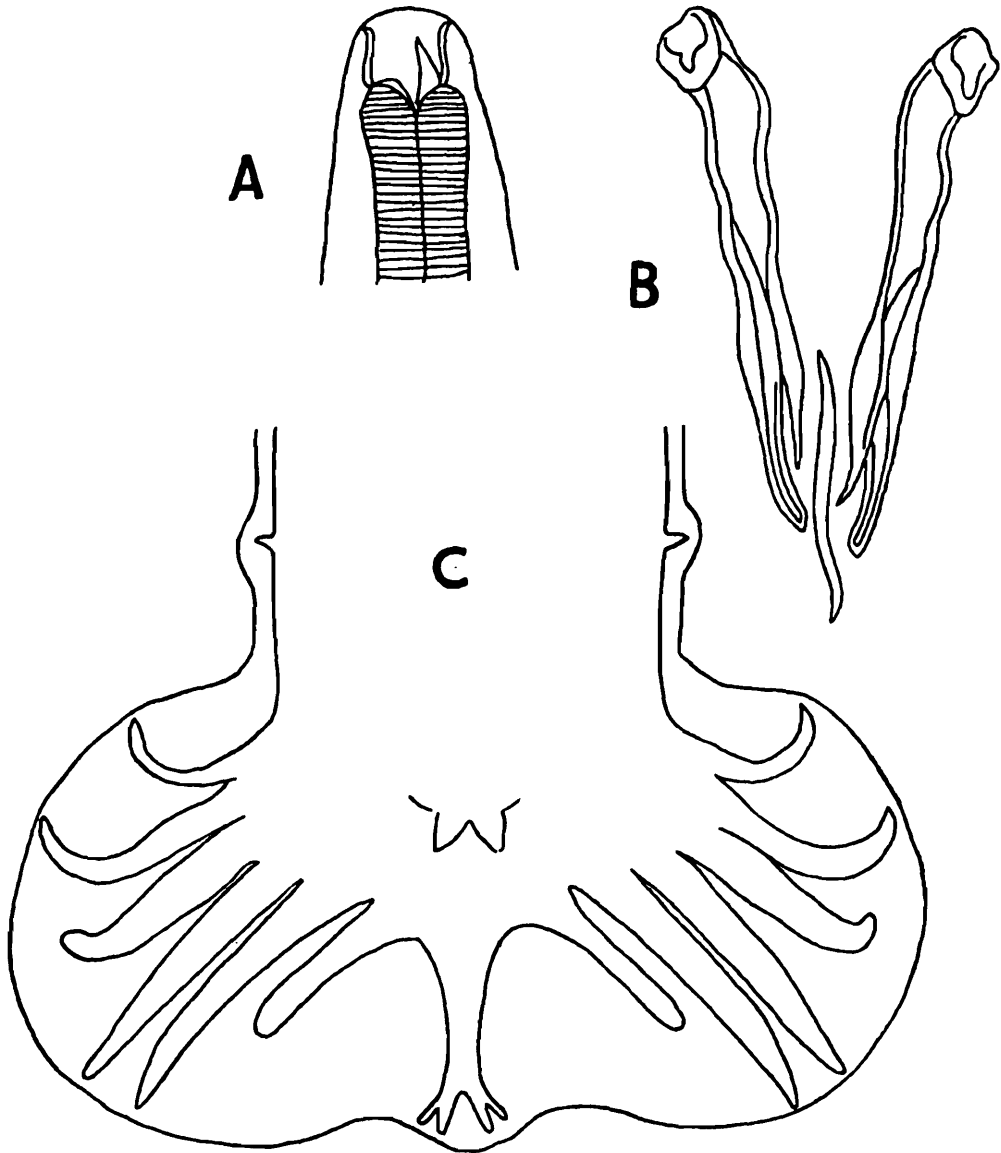

Fig. 168.—*Amidostomum skrjabini*. A, anterior end, lateral view; B, spicules and accessory piece, ventral view; C, bursa of male, ventral view. (After Boulenger, in 'Parasitology'.)

The tail of the female is about 0.19–0.27 mm. long, and is tapering, with a rounded tip. It bears a pair of papillæ somewhat behind its middle. The vulva is situated at about 1.7–2.6 mm. from the posterior end. The ovejectors have a combined length of 0.4–0.5 mm. The eggs measure 0.07–0.082 × 0.04–0.052 mm.

2. Genus **PSEUDAMIDOSTOMUM** Boulenger, 1926.

Head with a slightly inflated cuticular cap, without projections. Buccal capsule wide but very short, without teeth. Ventral rays of bursa divergent. Lateral rays parallel; the antero-lateral ray short and stout, the medio-lateral and postero-lateral rays longer and more slender, and nearly reaching the edge of the bursa. Dorsal ray stout at its base, near to which it gives origin to the short externo-dorsal rays; cleft distally, each branch being bidigitate. Prebursal papillæ present. Each spicule composed distally of two processes fused together. Accessory piece absent. Tail of female suddenly narrowed behind the anus. Adult worms parasitic in birds.

Genotype:—*Pseudamidostomum loossi* Boulenger, 1926.

1. **Pseudamidostomum boulengeri** Maplestone, 1930.

Hosts:—This species is recorded by Maplestone from the cotton teal (*Nettapus coromandelianus*), the cattle egret (*Bubulcus ibis coromandus*) and an unidentified duck, in the Zoological Gardens, Calcutta. Its habitat is not stated, but is presumably under the horny lining of the gizzard.

The male measures 8.3–8.6 mm. in length and 0.18–0.21 mm. in maximum thickness, the female 11–11.5 mm. and 0.22–0.24 mm. respectively. The cuticle is transversely striated. The diameter of the head is 0.04–0.044 mm. The mouth is situated in a shallow, funnel-shaped depression and surrounded by four elongate submedian papillæ and a pair of inconspicuous lateral papillæ. The œsophagus is about 1 mm. long in the male, 1.3–1.4 mm. in the female, and is very slightly swollen posteriorly. In the female the nerve-ring and excretory pore are situated at 0.3 mm., and the cervical papillæ at 0.56 mm., from the anterior extremity.

In the male the ventral lip of the cloacal aperture bears a pair of papillæ. The prebursal papillæ, in Maplestone's material, were asymmetrical. The spicules measure 0.12–0.124 mm. in length, and are stout, slightly curved and provided with broad, membranous alæ. "Their tips are not divided though there appear to be double tips, which are fused."

The tail of the female is 0.28 mm. long, and bears a pair of papillæ somewhat behind its middle. The vulva is situated at 2.7–2.8 mm. from the posterior end. The eggs measure 0.116–0.12 × 0.07–0.08 mm.

3. Genus **EPOMIDIOSTOMUM** Skrjabin, 1916.

Cuticle thick, with conspicuous transverse striations. Head distinct, with backwardly-directed "epaulettes" or "festoons," or with a number of spines, including a dorsal and a ventral pair which are stout and backwardly directed. Buccal cavity reduced or absent. Œsophagus with three internal chitinous lamellæ. Ventral rays of bursa diverge from lateral rays. Antero-lateral ray short, not reaching the margin of the bursa. Medio-lateral and postero-lateral rays parallel and fused proximally. Externo-dorsal rays short and thick. Terminations of dorsal ray short and bidigitate. The posterior lip of the cloacal aperture bears a pair of large papillæ. Prebursal papillæ present. Spicules short, trifurcate distally. Accessory piece absent. Tail of female narrows rapidly behind the anus and is bent ventrally. Uterine branches opposed. Adult worms parasitic in the gizzard of Anseriform birds, under the horny lining.

Genotype :—*Epomidiostomum uncinatum* (Lundahl, 1848).

1. **Epomidiostomum uncinatum** (Lundahl, 1848) Seurat, 1918. (Fig. 169.)

Synonyms :—*Strongylus uncinatus* Lundahl, 1848; *Epomidiostomum anatinum* Skrjabin, 1916.

Hosts :—This species has been recorded from a considerable number of Anseriform birds, including the domestic duck, and in many parts of the world (Europe, Asia and Africa). Maplestone has recorded it from various ducks in the Zoological Gardens, Calcutta, including *Dafila acuta*, *Nyroca rufa* [*Fuligula nyroca*], *Querquedula querquedula* [*Q. circia*], *Sarkidiornis melanotos* and *Casarca ferruginea* [*Tadorna casarca*].

The male measures 6.3–7.13 mm. in length and 0.15 mm. in maximum thickness, the female 10–11.5 mm. and 0.25 mm. respectively. The structure of the head has been variously interpreted by different authors, and seems not to have been understood until Maplestone (1930, *b*) gave a fuller description of it. According to his account and figures the head is surmounted by a cuticular cap, the four angles of which are produced into a pair of subdorsal and a pair of subventral stout, backwardly-directed spines. The mouth, which is situated in the centre of the cap, is surrounded by four prominent, forwardly-directed papillæ, and a pair of less conspicuous lateral papillæ is also present. The buccal capsule, according to Maplestone, is "difficult to see, as it can only be viewed through the chitinous cap overlying the head." The Œsophagus is about 0.8 mm. long.

The dorsal ray of the bursa is very stout at its base, near to which it gives origin to the externo-dorsal rays, whose bases are also very stout. The spicules measure 0.12–0.13 mm. in length.

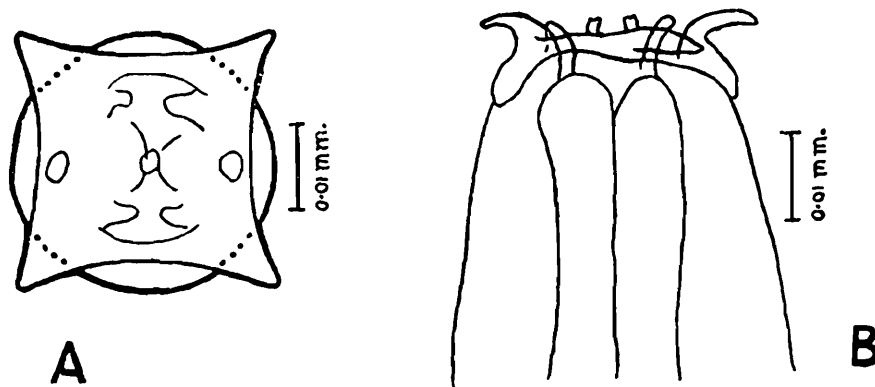

Fig. 169.—*Epomidiostomum uncinatum*. Anterior end. A, apical view; B, semi-lateral view. (After Maplestone.)

The tail of the female is 0.14–0.17 mm. long, and has a button-like termination. The vulva is situated at about 2.2 mm. from the posterior end. The eggs measure 0.074–0.08 × 0.048–0.05 mm.

16. Family TRICHOSTRONGYLIDÆ Leiper, 1912.

Mainly small, slender forms. Mouth without cutting organs or leaf-crown. Buccal capsule usually vestigial or absent in the adults. Bursa of male well developed, with large lateral lobes but with a small or ill-defined dorsal lobe. Adults parasitic in the alimentary canal of vertebrates.

Subfamily TRICHOSTRONGYLINÆ Leiper, 1908.

Female genital tubes paired. Vulva behind the middle of the body, but usually at some distance from the posterior end.

Key to Genera.

- | | |
|--|---|
| Dorsal lobe of bursa of male asymmetrical. | HÆMONCHUS, p. 373. |
| Dorsal lobe of bursa symmetrical . | 1. |
| 1. Ventral rays of bursa widely separated | 2. |
| Ventral rays of bursa close together . | 3. |
| 2. Spicules of male relatively short and stout,
of irregular outline and not united | [p. 362. |
| Spicules long and filiform, united for most
of their length. | TRICHOSTRONGYLUS,
MÉCISTOCIRRUS, p. 382. |

- | | |
|--|--------------------------------|
| 3. Dorsal lobe of bursa divided into two small lobules, each supported by a separate ray | NEMATODIRUS, p. 379. |
| Dorsal lobe of bursa entire; dorsal ray divided only distally | 4. [p. 384. |
| 4. Parasites of reptiles and amphibians | OSWALDOCRUZIA, |
| Parasites of warm-blooded vertebrates | 5. |
| 5. Parasites of mammals | OSTERTAGIA, p. 366. |
| Parasites of birds | ORNITHOSTRONGYLUS,
[p. 372. |

1. Genus **TRICHOSTRONGYLUS** Looss, 1905.

Synonym:—*Libyostrongylus* Lane, 1923.

Cuticle of anterior end may be inflated. Buccal capsule ill defined. Ventral rays of bursa widely separated and of different thicknesses, the ventro-ventral ray being slender and ventrally directed, the latero-ventral ray stout and nearly parallel to the lateral rays. Postero-lateral ray thinner than, and divergent from, the other lateral rays. Dorsal ray cleft near its tip, each branch having two short terminal digitations. Prebursal papillæ present. Spicules short and spoon- or spatula-shaped, often having a twisted appearance owing to the development of ridges or other projections on their surfaces. An elongate accessory piece present. Vulva typically with prominent lips. Eggs thin-shelled; their contents segmenting at the time of laying. Adult worms parasitic in herbivores, rodents, Primates and birds.

Genotype:—*Trichostrongylus retortæformis* (Zeder, 1800).

Key to Species.

- | | |
|--|---------------------------------|
| Parasite of hare | <i>pigmentatus</i> , p. 365. |
| Parasites of ruminants | 1. |
| I. Each spicule of male with a single ventral projection or barb | <i>colubriiformis</i> , p. 362. |
| Each spicule of male with a second angular ventral projection in front of the barb | <i>probolurus</i> , p. 364. |

1. **Trichostrongylus colubriiformis** (Giles, 1892) Ransom, 1911. (Fig. 170.)

Synonyms:—*Strongylus colubriiformis* Giles, 1892; *Strongylus instabilis* Railliet, 1893; *Strongylus subtilis* Looss, 1905; *Trichostrongylus subtilis* Looss, 1905; *Trichostrongylus delicatus* Hall, 1916.

Hosts:—This is a common and widely-distributed parasite of the fourth stomach and small intestine of many ruminants, including the sheep, goat and camel. It also sometimes occurs in the intestine of other mammals, having been recorded from squirrels, the chimpanzee, various monkeys and man. In India (Assam and the Punjab) it has been recorded from

sheep by Giles and by Lane. A species of *Trichostrongylus*, in all probability *T. colubriformis*, appears to occur not infrequently in man in at least some parts of India. Boulenger (1920) records the finding of the eggs of *Trichostrongylus* in the stools of a small percentage of Indian hospital patients in Mesopotamia, while Sweet (1929) estimates the incidence of such eggs in the State of Mysore as 0.4 per cent. of the population.

The male measures about 4.4–7.7 mm. in length and 0.07–0.11 mm. in maximum thickness, the female about 5.1–8.6 mm. and 0.08–0.12 mm. respectively. The diameter of the head is 0.013–0.017 mm. The oesophagus is about 0.6–1 mm. long. The excretory pore is situated at 0.11–0.17 mm. from the anterior end.

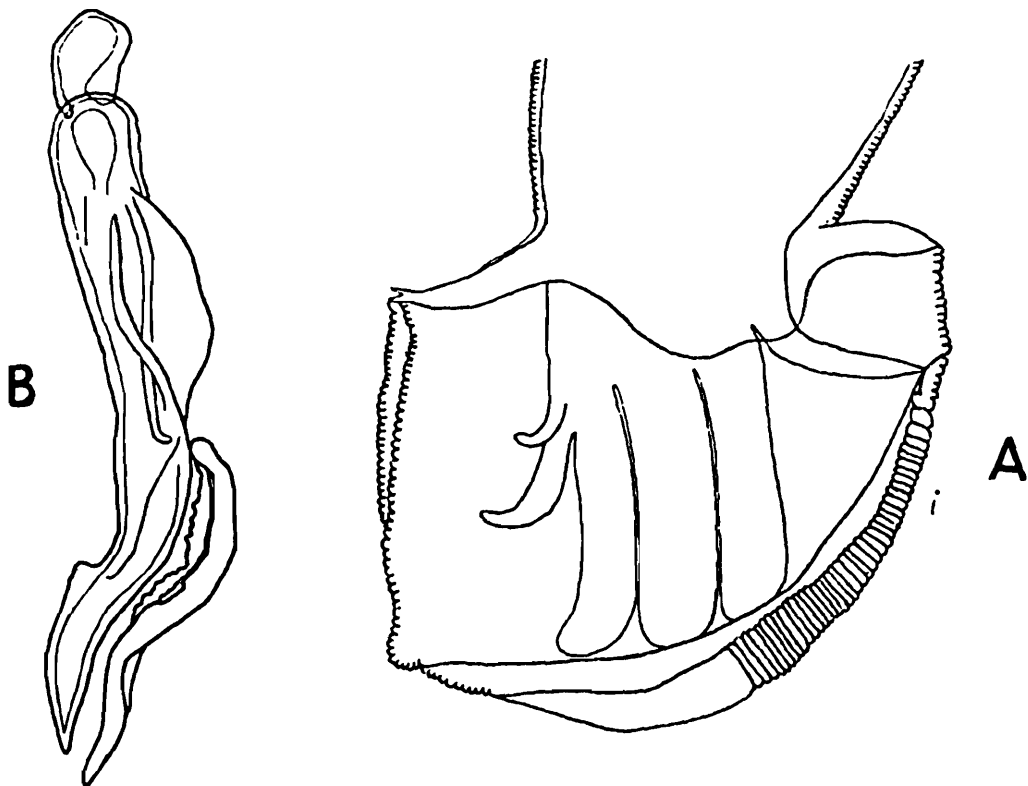

Fig. 170.—*Trichostrongylus colubriformis*. A, bursa of male, lateral view; B, left spicule and accessory piece, viewed from left side. (After Nagaty.)

The bursa is large and deeply bilobed, with a very small dorsal lobe. The antero-lateral ray is usually the stoutest. The postero-lateral ray is relatively small, and its tip is directed towards the externo-dorsal ray. The dorsal ray bifurcates at about its posterior third. According to Nagaty (1932) "the inner divisions are longer than the outer and bear on their inner surfaces a small papilla-like projection which is more marked in some than in others." The spicules are dark brown and somewhat unequal, the left spicule being longer and broader than the right. The left spicule measures

0.136–0.171 mm., the right 0.123–0.154 mm. in length. At about its posterior quarter each spicule bears a rather prominent ventral barb. The accessory piece, which measures 0.066–0.088 mm. in length, is canoe-shaped in dorso-ventral and somewhat S-shaped in lateral view.

The tail of the female is 0.055–0.092 mm. long, rather slender and sharply pointed. The vulva is situated at about 1–1.8 mm. from the posterior end, and is a longitudinal slit with a raised cuticular border. The combined length of the ovejectors is about 0.4–0.6 mm. The eggs measure 0.073–0.096 × 0.035–0.048 mm.

2. *Trichostrongylus probolurus* (Railliet, 1896) Looss, 1905.
(Fig. 171.)

Synonym :—*Strongylus probolurus* Railliet, 1896.

Hosts :—This species occurs in the duodenum of ruminants, including the sheep and camel, in various parts of the world.

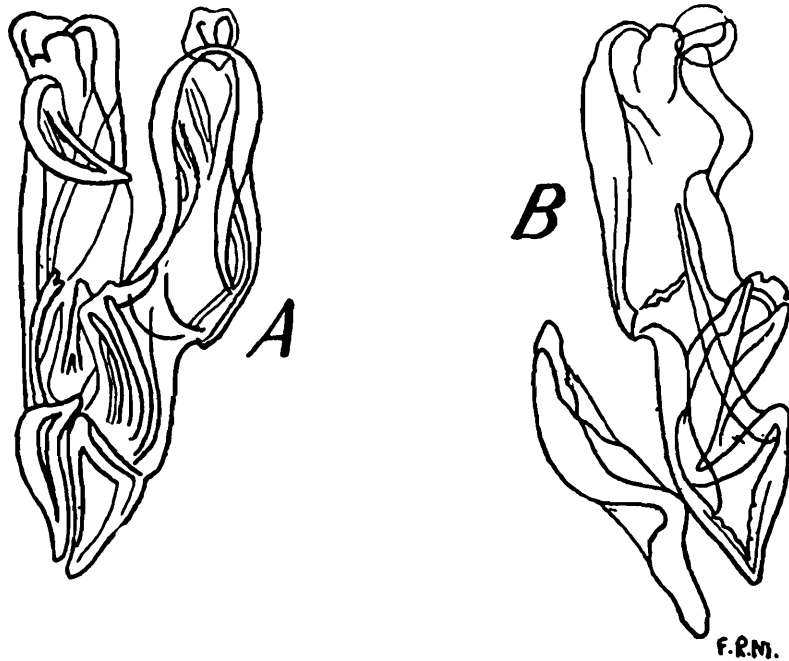

Fig. 171.—*Trichostrongylus probolurus*. Spicules and accessory piece. A, ventral view; B, lateral view. (From Baylis, after Looss.)

It has also been recorded as an accidental parasite of man. Nagaty (1932) records a single male specimen from a sheep from the Punjab. This specimen was discovered among Giles' original material of *T. colubriformis*.

The following description is taken from Ransom (1911). The male measures 4.5–5.5 mm. in length, the female 4.5–6 mm., and both measure 0.08 mm. in maximum thickness.

The latero-ventral ray is much the stoutest of the bursal rays. The postero-lateral and externo-dorsal rays are very

short and close together. The dorsal ray has a short and stout stem and short, bidigitate terminations. The spicules measure 0.126–0.134 mm. in length and are relatively stout. Each has a very pronounced terminal hook or barb. In front of this “on the ventral edge of the spicule is a second angular pointed projection, which together with the terminal hook when observed under low magnification, gives the spicule a gnarled or twisted appearance.” The accessory piece is 0.075–0.08 mm. long.

In the female the posterior portion of the body is rather stout, beginning to taper rapidly a short distance in front of the anus. The tail is rather blunt and measures 0.04–0.05 mm. in length. The vulva, which is a longitudinal slit, is situated at about 1–1.25 mm. from the posterior end. The combined length of the ovejectors is about 0.375 mm. The eggs measure 0.076–0.08 × 0.043–0.046 mm.

3. *Trichostrongylus pigmentatus* (v. Linst., 1904) Hall, 1916.

Synonym :—*Strongylus pigmentatus* v. Linstow, 1904.

Host :—This parasite is recorded from the stomach of the black-naped hare (*Lepus nigricollis*) at Ranna, Southern Province, Ceylon.

Of this species nothing is known beyond the original description of it by v. Linstow. The type-specimens should be in the collection of the Colombo Museum, but apparently cannot now be found, and the writer has therefore been unable to examine them.

According to v. Linstow's description the male measures 7.7 mm. in length and 0.12 mm. in thickness, the female 10.5 mm. and 0.14 mm. respectively. The head has three lips, each carrying on its summit a small papilla. The œsophagus occupies 1/14 of the total length in the male and 1/18 in the female. It measures, therefore, about 0.55–0.58 mm.

The bursa has two large lateral lobes and a small dorsal lobe. The dorsal ray has a long stem and very short, bifurcate terminal branches, the inner termination of each branch being longer than the outer. All the other rays of the bursa are figured as being slender and of about equal thickness, but the figure is probably somewhat diagrammatic. The length of the spicules is given as 0.68 mm., but this measurement, as suggested by Hall (1916), should probably be 0.068 mm. They are of a pale brown colour, and each is divided distally into three processes, of which the largest is blunt, the others pointed.

The tail of the female measures 1/66 of the total length (*i. e.* about 0.15 mm.) The vulva divides the total length

in the ratio of 37:11, and is therefore situated at about 2.4 mm. from the posterior end. The eggs measure 0.062×0.036 mm.

v. Linstow states that the "œsophagus, testes, uterus, eggs and especially the ovaries are coloured black." This peculiarity in the type-specimens was no doubt an artifact due to some reagent to which they had been subjected.

2. Genus **OSTERTAGIA** Ransom, 1907

Synonym :—*Camelostrongylus* Orloff, 1933.

Cuticle of body marked with numerous (twenty-five to thirty) longitudinal ridges. Cuticle of head may be slightly dilated. Cervical papillæ present. Buccal cavity small. Bursa of male with two lateral lobes and a smaller dorsal lobe. Within the bursa dorsally there is typically an accessory bursal membrane with a free posterior edge and supported by two slender, divergent rays. Prebursal papillæ present. Ventral rays close together and parallel. Dorsal ray with two main branches, each giving off one or two short accessory branches. Spicules rather short, usually divided distally into three processes. An accessory piece may be present or absent. Vulva towards the posterior end of the body, sometimes covered by a cuticular flap developed from its anterior lip. Adult worms parasitic in mammals, chiefly ruminants.

Genotype :—*Ostertagia ostertagi* (Stiles, 1892).

Key to Species.

Spicules of male 0.5 mm. long, or longer ..	<i>mentulata</i> , p. 372.
Spicules of male not more than 0.32 mm. long	1.
1. Latero-ventral ray of bursa the stoutest	2.
Antero-lateral ray of bursa the stoutest	3.
2. Spicules with a longer, knobbed, outer process and two shorter, barbed, inner processes. .	<i>ostertagi</i> , p. 366.
Spicules with a short, blunt, dorsal process and two ventral processes, one slightly knobbed, the other pointed	<i>marshalli</i> , p. 369.
3. One process of each spicule knobbed, two processes pointed	[p. 367.
Two processes of each spicule knobbed or blunt, one process pointed	<i>circumcincta</i> ,
	<i>occidentalis</i> , p. 370.

1. *Ostertagia ostertagi* (Stiles, 1892) Ransom, 1907.

Synonyms :—*Strongylus convolutus* Ostertag, 1890 (*nec* Kuhn, 1829); *Strongylus ostertagi* Stiles, 1892; *Strongylus harkeri* Stödter, 1901 (part).

Hosts :—This species occurs in nodules in the wall of the abomasum, or free in its cavity or in the duodenum, of cattle

and sheep in various parts of the world. It has also been recorded from the bharal (*Ovis nahura*) in captivity in the United States of America, and from the roe-deer and chamois in Europe. Bhalerao (1935, *b*) records it from cattle (*Bos indicus*) at Muktesar, United Provinces.

The male measures 6.5–7.5 mm. in length and 0.115–0.15 mm. in maximum thickness, the female 8.3–9.2 mm. and 0.12–0.16 mm. respectively. The diameter of the head is 0.016–0.02 mm. The œsophagus is 0.65–0.68 mm. long. The nerve-ring is situated at 0.26–0.28 mm., the excretory pore at about 0.3 mm., and the cervical papillæ at 0.32–0.34 mm., from the anterior extremity.

The bursa is relatively small. The ventral and lateral rays are of about equal thickness, but the latero-ventral ray is slightly thicker than the others. The tips of the ventral rays are very close together, as are those of the medio-lateral and postero-lateral rays. The dorsal ray is bifurcated at about its posterior third, each branch being slender and having two short terminations. An accessory bursal membrane, supported by two slender rays, is present. The spicules are about 0.2–0.23 mm. long. Each has two barbed processes on its inner side in the posterior half. These are united by a membrane with the main shaft, which ends in a knob. The accessory piece consists of an oval body, about 0.04 mm. long, and a posterior process about 0.025 mm. long.

The tail of the female is tapering and measures 0.1–0.14 mm. in length. The vulva is situated at 1.3–1.5 mm. from the posterior end, and is covered by a prominent cuticular flap. The combined length of the ovejectors, including the sphincters, is 0.2–0.26 mm. The eggs measure 0.065–0.08 × 0.03–0.04 mm.

2. *Ostertagia circumcincta* (Stadelmann, 1894) Ransom, 1907 (Figs. 172 & 173.)

Synonyms :—*Strongylus circumcinctus* Stadelmann, 1894 ; *Strongylus cervicornis* McFadyean, 1897 ; *Ostertagia (Ostertagia) circumcincta* Orloff, 1933 ; ? *Strongylus vicarius* Stadelmann, 1893.

Hosts :—This is a cosmopolitan parasite of sheep and goats, and also occurs in various wild ruminants. It inhabits the abomasum (fourth stomach) and small intestine. It is recorded by Bhalerao (1932) from the Himalayan ibex (*Capra sibirica*) at Muktesar, United Provinces.

The male measures 7.5–11 mm. in length, the female 9–12.2 mm. In both sexes the maximum thickness is 0.1–0.165 mm. The head has a diameter of about 0.018–0.022 mm. The œsophagus is 0.5–0.69 mm. long. The cervical papillæ are situated at 0.21–0.35 mm. from the anterior end, and the

nerve-ring and excretory pore at about the same level (a little in front of the middle of the œsophagus).

The antero-lateral ray of the bursa is the stoutest. Each main branch of the dorsal ray has two short accessory branches, one on the inner side near the tip and one on the outer side higher up. The spicules measure 0.28–0.32 mm. in length, and have three terminal processes. The outer of these is longer and stouter than the others, and ends in a knob. The

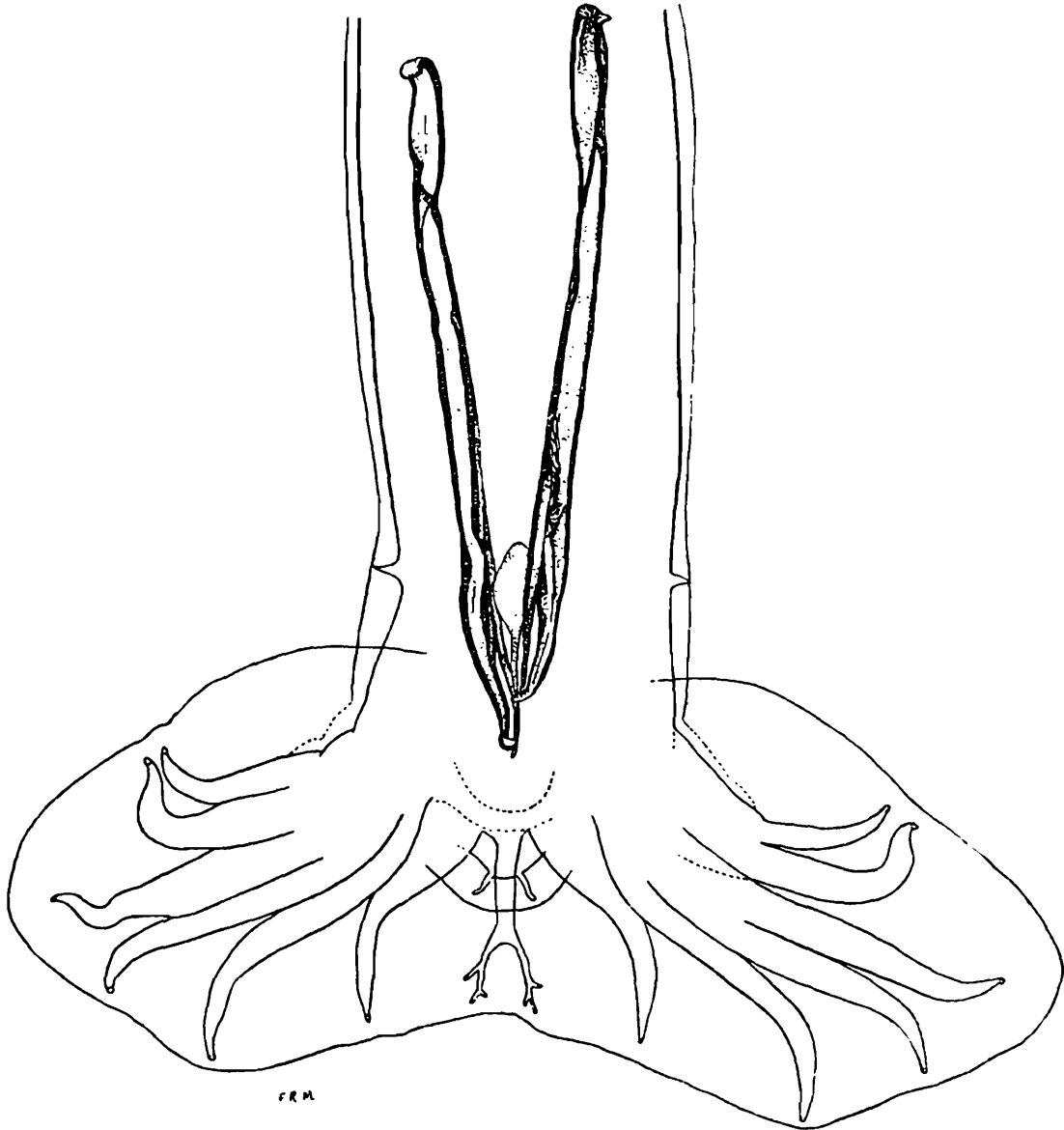

Fig. 172.—*Ostertagia circumcincta*. Posterior end of male; ventral view. (From Baylis, after Travassos.)

two inner processes are slender, tapering and pointed, and one of them is considerably longer than the other. The accessory piece is about 0.08–0.09 mm. long. It has a spatulate anterior portion and a long, slender posterior portion.

The tail of the female is 0.13–0.19 mm. long, and is tapering, with a blunt tip. Near the tip there is a slightly raised band composed of some three to five annulations. The vulva is

situated at 1.5–2.5 mm. from the posterior end, and is usually covered by a flap. The combined length of the ovejectors is 0.33–0.56 mm. The eggs measure 0.075–0.1 × 0.035–0.05 mm.

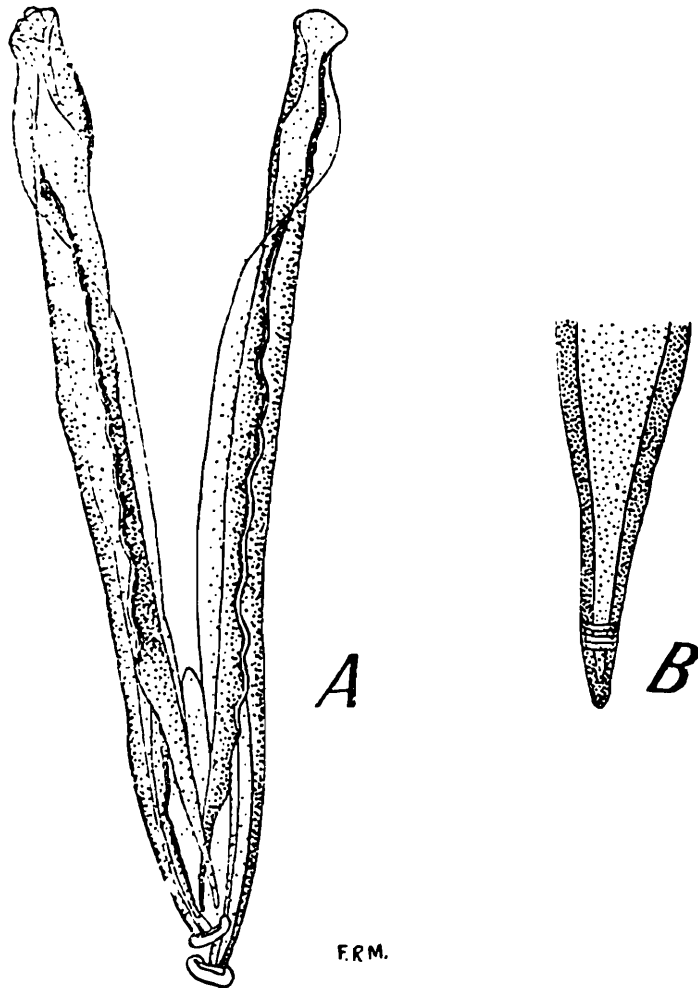

Fig. 173.—*Ostertagia circumcincta*. A, spicules and accessory piece, ventral view; B, posterior extremity of female. (From Baylis, after Ransom.)

3. *Ostertagia marshalli* Ransom, 1907.

Synonyms :—*Ostertagia tricuspis* Marotel, 1910 ; *Ostertagia orientalis* Bhalerao, 1932 ; *Ostertagia (Marshallagia) marshalli* Orloff, 1933 ; ? *Ostertagia brigantiaca* Blanchard, in Railliet and Henry, 1909.

Hosts :—This species occurs in the abomasum and small intestine of sheep and goats in various parts of the world (Europe, Asia and America). It also occurs in the chamois. Bhalerao (1932) records what he regards as a distinct species, *O. orientalis*, from the Himalayan ibex (*Capra sibirica*) at Muktesar, United Provinces. The slight differences in measurements mentioned do not, however, appear sufficient to justify the separation of Bhalerao's species from *O. marshalli*.

The male measures 9.5–14.3 mm. in length and 0.11–0.2 mm. in maximum thickness, the female 12–21.7 mm. and 0.19–0.26 mm. respectively. The diameter of the head is 0.013–0.023 mm. The œsophagus is about 0.7–0.97 mm. long. The nerve-ring is situated at about its anterior third (according to Bhalerao at 0.29–0.365 mm. from the anterior end). The excretory pore is slightly behind the nerve-ring, and the cervical papillæ at 0.32–0.48 mm. from the anterior extremity.

The latero-ventral ray is the stoutest of the bursal rays. The dorsal ray is very long and slender. Each of its branches is very slightly cleft at the tip, and gives off a very small accessory branch on the outer side a little before the tip. The spicules are about 0.18–0.28 mm. long, or, according to Bhalerao, as much as 0.31 mm. At about a quarter to three-eighths of their length from the tip they are divided into three processes, two of which are ventral and one dorsal. The dorsal process is shorter, broader and less conspicuous than the others, and has a blunt tip. According to Bhalerao it ends in a small knob. The ventral processes are slender, the inner being slightly knobbed, while the outer is longer and sharply pointed. According to Bhalerao the outer process "gives out a small, slender process at a short distance from its tip." There is no accessory piece.

The tail of the female is slender and tapering, and has a blunt tip. It measures about 0.2–0.3 mm. in length. The vulva is a transverse slit situated at 1.8–5 mm. from the posterior end, and sometimes covered by a backwardly-projecting flap. According to Bhalerao, "occasionally an anterior or a posterior flap may be present." The combined length of the ovejectors is about 0.58–0.64 mm. The eggs measure 0.15–0.23 × 0.07–0.116 mm.

4. *Ostertagia occidentalis* Ransom, 1907 (Fig. 174.)

Synonyms :—*Ostertagia trifida* Cuillé, Marotel and Panisset, 1911 ; *Ostertagia skrjabini* Kamensky, 1929 ; *Ostertagia (Grosspiculagia) occidentalis* Orloff, 1933.

Hosts :—This parasite occurs in the abomasum and small intestine of sheep in Europe, Asia and America, and has also been recorded from the chamois. Bhalerao (1932) records it from the Himalayan ibex (*Capra sibirica*) at Muktesar, United Provinces.

Most authors have found the female of this species indistinguishable from that of certain closely-related forms. Bhalerao was unable to separate it from that of *O. orientalis* (i. e. *O. marshalli*). The measurements of the female in the

following description are taken from Guschanskaja and Krjukowa, as quoted by Gebauer (1932).

The male measures 9–16 mm. in length and about 0.15–0.24 mm. in maximum thickness. The female is 10.8–14.5 mm. long. The diameter of the head is 0.012–0.023 mm. The œsophagus measures 0.51–0.98 mm. in length. The nerve-ring is situated at about its anterior third, and the cervical papillæ at 0.32–0.4 mm. from the anterior end.

The antero-lateral ray of the bursa is usually the thickest. The dorsal ray is long and slender, and bifurcates at about its posterior third. Each branch has a short accessory

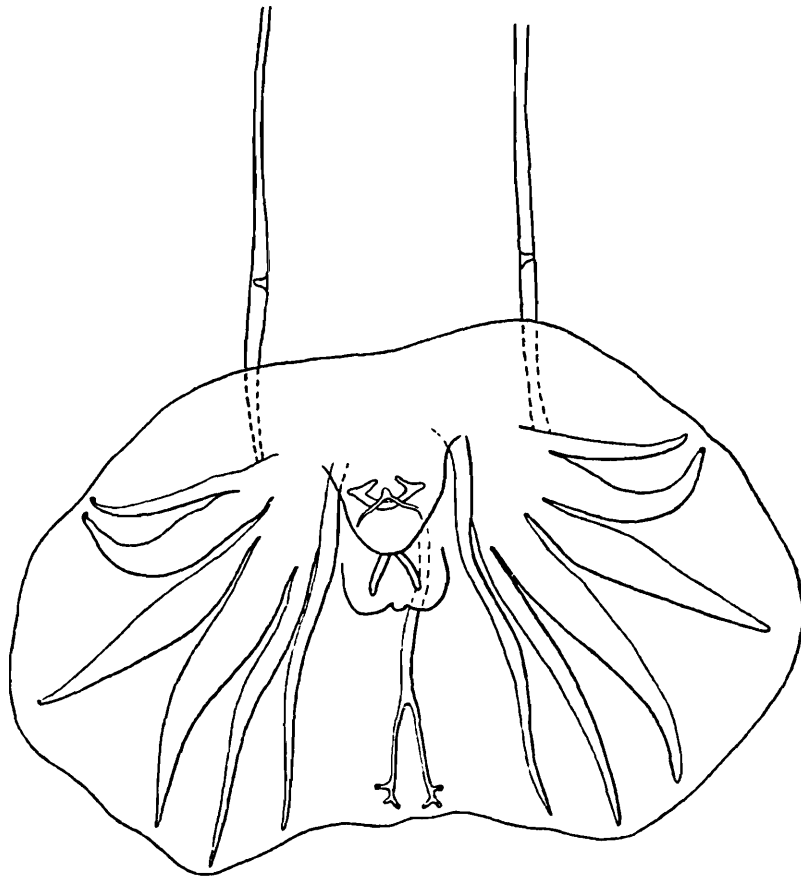

Fig. 174.—*Ostertagia occidentalis*. Posterior end of male; ventral view. (After Ransom.)

branch on the inner side near the tip, and one on the outer side a little higher up. The spicules are about 0.2–0.32 mm. long, and are relatively stout. A little behind its middle each spicule divides into three processes, two of which are ventral and one dorsal. The outer ventral process is the longest of the three, and ends in a knob. The inner ventral process is the shortest, and has a short subterminal point. The dorsal process is the thickest, and has a bluntly conical tip, marked off by a transverse ridge on the dorsal side. The

accessory piece, which is inconspicuous, is about 0.11–0.12 mm. long.

The tail of the female is 0.14–0.16 mm. long, and has three or four annulations near the tip. The vulva is situated at 2.24–3.01 mm. from the posterior end. The ovejectors have a combined length of 0.49–0.63 mm. The eggs measure 0.097–0.108 × 0.05–0.061 mm.

5. *Ostertagia mentulata* Railliet and Henry, 1909.

Synonyms :—*Camelostrongylus mentulatus* Orloff, 1933 ; ? *Strongylus capillaris* Pricolo, 1913.

Hosts :—This species occurs in the fourth stomach of the camel (*Camelus dromedarius*), and was originally recorded from India. It has also been recorded from the sheep in Europe and from the goat in Turkestan.

The male measures 6.5–7.5 mm. in length, the female 8–10 mm. Lateral alæ are present, in addition to the usual longitudinal ridges, in the posterior portion of the male. The œsophagus is 0.75–1 mm. long, and the cervical papillæ are situated at 0.35–0.45 mm. from the anterior end.

The spicules of the male are relatively long (0.5–0.7 mm.), transversely striated and of reticulated appearance. At its distal end each spicule carries two slightly unequal processes, about 0.09 mm. long and apparently articulated to the main shaft. These processes have hammer-shaped or button-like terminations.

The tail of the female is bluntly pointed. The vulva is situated in the posterior fifth of the body.

3. Genus **ORNITHOSTRONGYLUS** Travassos, 1914.

Synonym :—*Cephalostrongylus* Irwin-Smith, 1920.

Cuticle of anterior end inflated. A slight buccal capsule present. Ventro-ventral and latero-ventral rays of bursa of equal thickness and close together. Antero-lateral and medio-lateral rays close together proximally but widely divergent distally. Postero-lateral ray about as thick as, but divergent from, the other lateral rays. Dorsal ray cleft to a varying extent, up to half its total length ; each branch ending in three or four digitations. Externo-dorsal rays originate from the base of the dorsal ray. Prebursal papillæ present. Spicules relatively short, each ending in three pointed processes. An accessory piece (? telamon) present. Vulva in the posterior half of the body. Adult worms parasitic in the alimentary canal of birds.

Genotype :—*Ornithostrongylus fariai* Travassos, 1914.

1. *Ornithostrongylus travassosi* Maplestone, 1932.

Host :—This species is recorded by Maplestone from the gizzard of the coral-billed pigeon (*Chalcophaps indica*) in the Zoological Gardens, Calcutta.

The male measures 5·7 mm. in length and 0·88 mm. in maximum thickness, the female 7·8 mm. and 0·116 mm. respectively. The head has a diameter of 0·24 mm. According to Maplestone's description there is no buccal capsule. The œsophagus is 0·356 mm. long, and is slightly swollen towards its posterior end. The nerve-ring is situated at 0·2 mm., and the excretory pore, which is surrounded by an inflation of the cuticle, at 0·28 mm., from the anterior extremity.

The externo-dorsal rays almost reach the edge of the bursa. The spicules measure 0·144 mm. in length, and have membranous alæ along their inner borders. The accessory piece is 0·048 mm. long. Maplestone states that it is "Y-shaped when seen dorso-ventrally, and when seen from the side it appears as a straight rod with a rounded prominence running ventrally from about its centre."

The tail of the female measures 0·12 mm. in length, and ends in a spike which is 9μ long. It bears a pair of papillæ at 0·024 mm. from the tip. The vulva is situated at a distance of 1·87 mm. from the anus (*i. e.* at 1·99 mm. from the posterior end). The eggs measure 0·05–0·052 \times 0·027–0·028 mm.

Maplestone does not compare this species with *O. quadri-radiatus* (Stevenson, 1904), a form occurring in the intestine of domestic pigeons in America and elsewhere, but according to his description it differs from this form in its smaller size, the greater length of the externo-dorsal rays, the shape of the accessory piece and the smaller size of the eggs.

4. Genus **HÆMONCHUS** Cobb, 1898.

A small buccal cavity present, containing a lancet-like dorsal tooth which originates at its base. A pair of well-developed, spine-like cervical papillæ present. Bursa with large lateral lobes and a small, asymmetrical dorsal lobe attached to the left lateral lobe near its base. Ventral rays divergent distally. Dorsal ray bifurcate distally; each branch with two small terminal digitations. Externo-dorsal rays long and slender; the left ray originating with the main stem of the dorsal ray in the left lateral lobe of the bursa. Prebursal papillæ present. Spicules relatively short, each with a small barb near its tip. An accessory piece present. Vulva usually covered by a cuticular flap; this, however, is subject to great variation. Adult worms parasitic in the stomach or small intestine of mammals, chiefly ruminants.

Genotype :—*Hæmonchus contortus* (Rud., 1803).

Key to Species.

Spicules of male 0.6 mm. long, or longer	<i>longistipes</i> , p. 378.
Spicules of male not more than about 0.5 mm. long	1.
1. Barb of left spicule at about 0.01–0.02 mm. from the tip	<i>contortus</i> , p. 374.
Barb of left spicule at about 0.04–0.06 mm. from the tip	<i>similis</i> , p. 378.

1. ***Hæmonchus contortus*** (Rud., 1803) Cobb, 1898. (Figs. 175–178.)

Synonyms:—*Strongylus contortus* Rudolphi, 1803; *Strongylus hæmonchus* Stewart, 1912; ? *Hæmonchus cervinus* Baylis and Daubney, 1922.

Hosts:—This is a cosmopolitan parasite of the ox, sheep, goat and various wild ruminants, occurring in the stomach (usually in the abomasum) and less commonly in the small intestine, and being perhaps the commonest cause of verminous gastritis in these animals. It has been recorded as an accidental parasite of man. The species appears to be of frequent occurrence in India. It has been recorded by Gaiger from the ox and sheep in the Punjab, by Bhalerao from “goats” [sc. *Capra sibirica*] at Muktesar, United Provinces, and by Baylis and Daubney from the markhor (*Capra falconeri*) in the Zoological Gardens, Calcutta. It seems probable that the form described by Baylis and Daubney (1922), under the name of *Hæmonchus cervinus*, from the spotted deer (*Cervus axis*) is identical with *H. contortus*. The only male specimen available was much damaged, and the females agreed in measurements with small specimens of *H. contortus*. The absence of a vulvar flap was noted at the time as a distinctive feature, but in view of the amount of variation now known to occur in this respect in *H. contortus*, no importance can be attached to this character.

The male measures about 10–20 mm. in length and 0.23–0.4 mm. in maximum thickness, the female about 18–30 mm. and 0.4–0.5 mm. respectively. The diameter of the head is about 0.03 mm. The buccal tooth is 0.01–0.015 mm. long, and may project through the mouth. The œsophagus is club-shaped and measures about 1.2–1.5 mm. in length. The nerve-ring and excretory pore are situated at about 0.28 mm., and the very prominent cervical papillæ at about 0.3–0.44 mm., from the anterior end.

The stem of the dorsal ray is only slightly longer than its branches. The spicules are of a dark brown colour and measure about 0.3–0.5 mm. in length. Each spicule has a small barb on its outer surface, that of the left spicule at about 0.014–0.02 mm. and that of the right at about 0.028–0.04 mm.

from the tip. The accessory piece is fusiform, with thickened edges, and about 0.2 mm. long.

The tail of the female is slender and sharply pointed, and measures 0.3–0.63 mm. in length. It bears a pair of papillæ at about 0.1 mm. from the tip. The vulva is situated at a

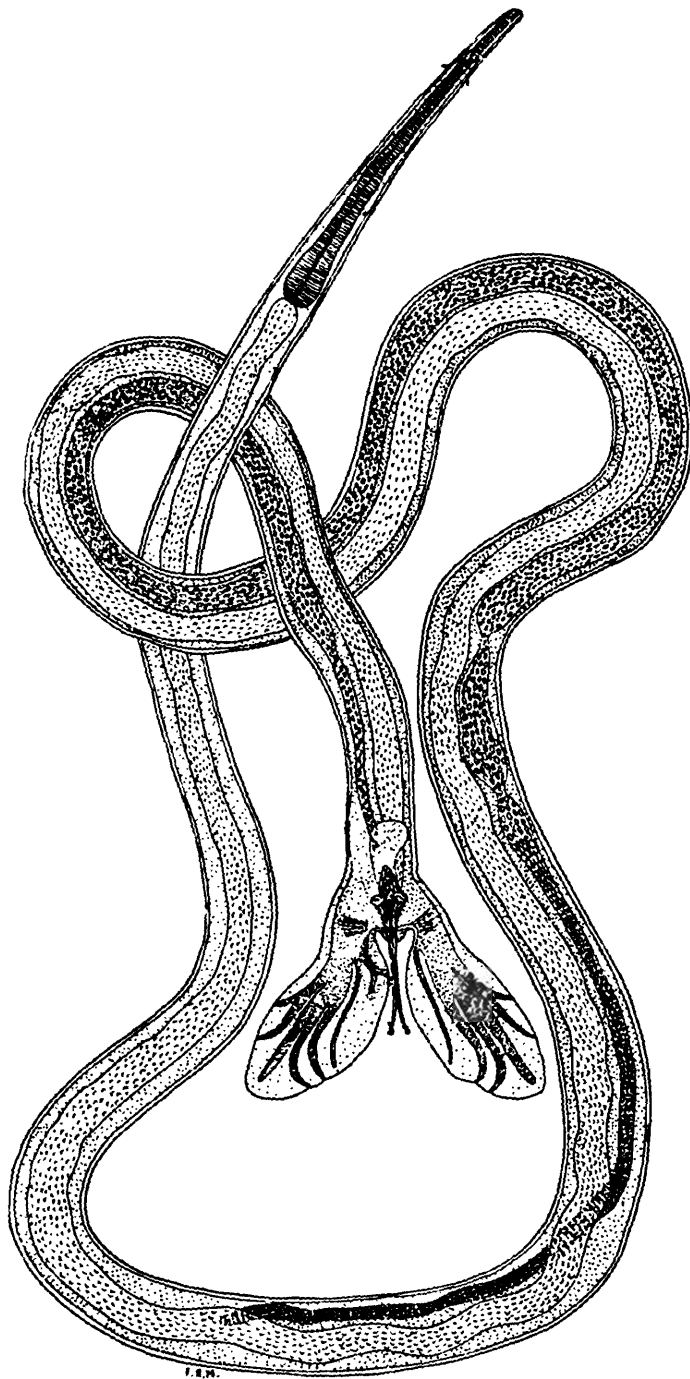

Fig. 175.—*Hæmonchus contortus*. Male. (From Baylis, after Neveu-Lemaire.)

distance of 3–5 mm. from the posterior end, and is usually covered by a backwardly-directed, tongue-shaped flap. This may, however, show great variations in form, being sometimes bilobed or represented by one or two cuticular bosses,

or may be absent. The combined length of the ovejectors is about 1 mm. The eggs measure $0.066-0.095 \times 0.04-0.05$ mm.

The life-history of this species, which is typical of the family, may be briefly described as follows. The eggs, whose contents are undergoing segmentation at the time of laying, may hatch within 24 hours after reaching the open. The larva

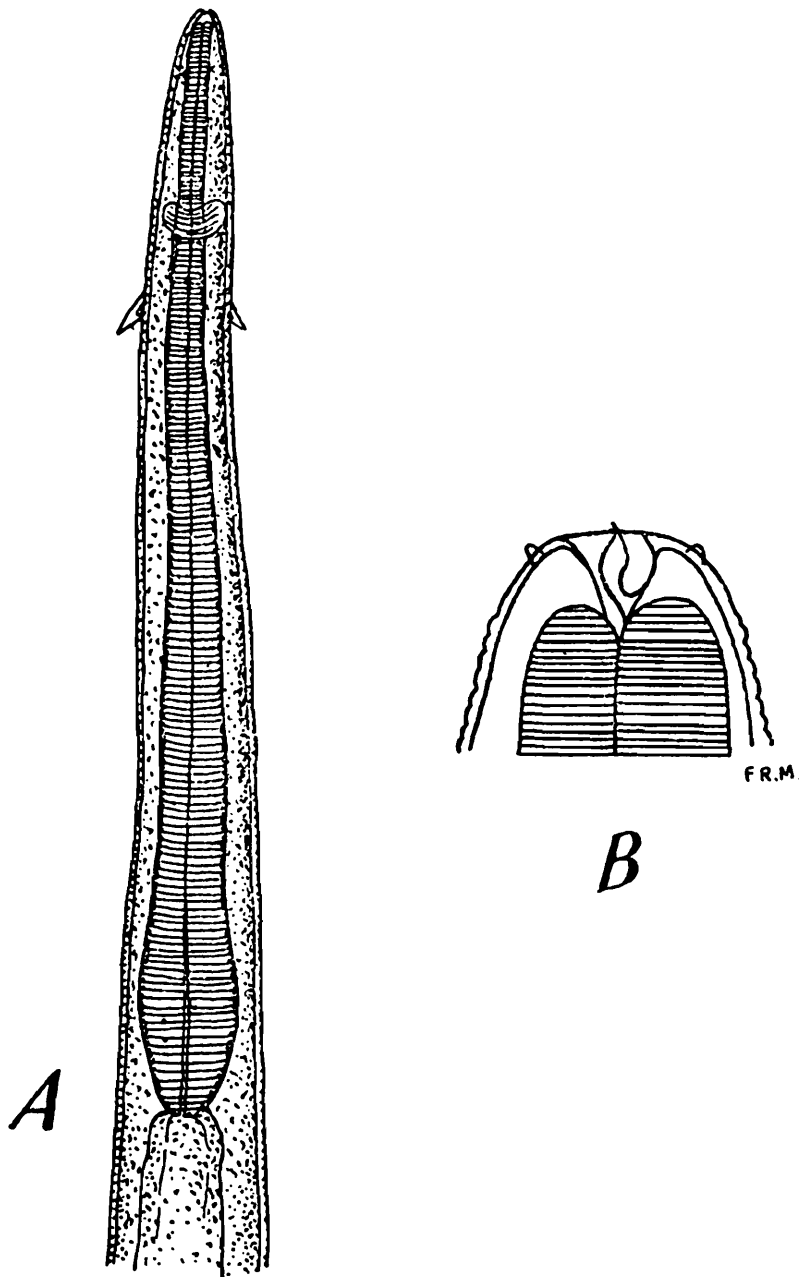

Fig. 176.—*Hæmonchus contortus*. A, anterior end, dorsal view (from Baylis, after Ransom); B, head, lateral view (from Baylis, after Yorke and Maplestone).

develops to the third (infective) stage within a period varying from four days to several weeks, according to the conditions of moisture and temperature. The infective larva, enclosed in a "sheath" consisting of the old cuticle of the second moult, is highly resistant to cold, dryness and chemical substances,

Fig. 177.

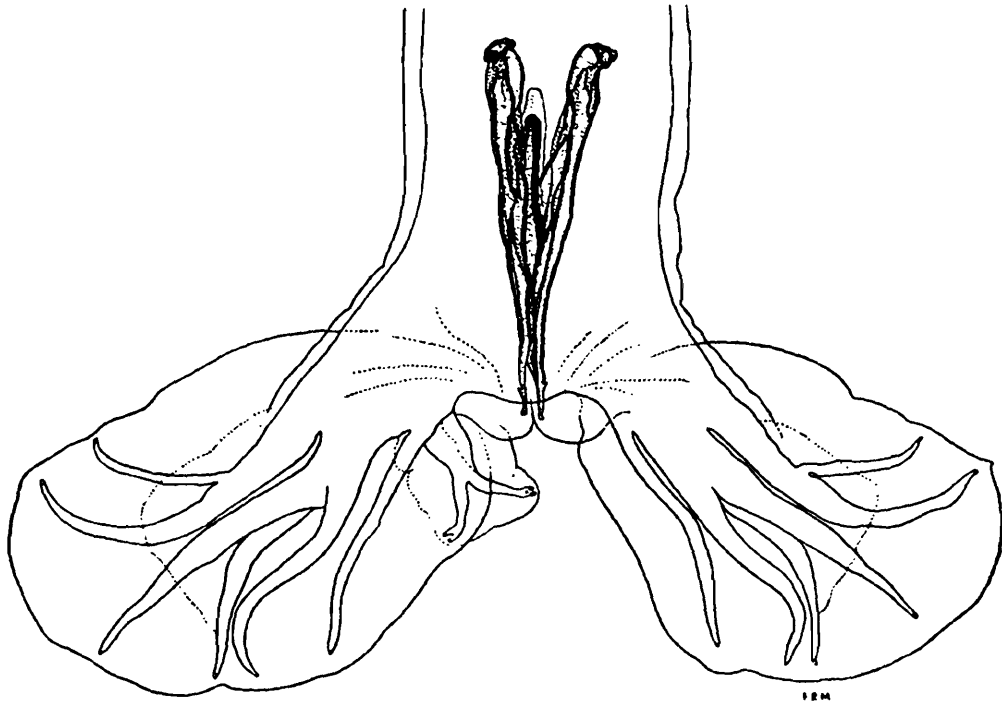

Fig. 178.

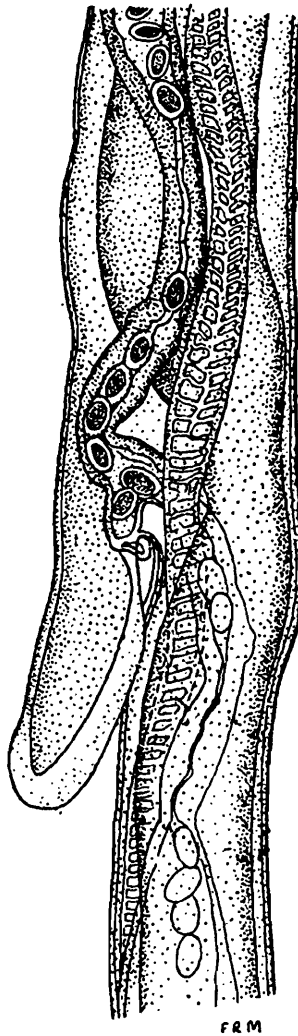

Fig. 177.—*Hæmonchus contortus*. Bursa of male ; dorsal view. (From Baylis, after Travassos.)

Fig. 178.—*Hæmonchus contortus*. Vulvar region of female ; lateral view. (From Baylis, after Ransom.)

and is capable of living for about a year in or on the ground. When the herbage is damp with dew or rain, and particularly during dull, warm weather, the larvæ climb up on to it, sometimes retreating into the soil again if the atmosphere becomes dry. If swallowed by a suitable host, the worms reach maturity in about three weeks.

2. *Hæmonchus similis* Travassos, 1914.

Synonym :—*Hæmonchus contortus* of Schnyder, 1906.

Hosts :—This species has been recorded from the abomasum of cattle in Europe and Brazil, and recently Bhalerao (1933, *b*) has recorded it in India from “hill bulls” (i. e. *Bos indicus*) at Muktesar. It has also been found by Isshiki (1933) in calves [*Bos taurus*] in Korea, and both these authors have given new descriptions of the parasite.

The male measures about 8.5–12.5 mm. in length and 0.18–0.24 mm. in maximum thickness, the female about 7.9–19.7 mm. and 0.12–0.5 mm. respectively. The cuticle has fine transverse striations and about 26 longitudinal striations. The buccal capsule is small, but contains a well-developed dorsal tooth, which is shaped like a spear-head in dorso-ventral view. The œsophagus is about 1–1.7 mm. long. The nerve-ring and excretory pore are situated at about 0.23–0.32 mm., and the cervical papillæ at about 0.3–0.4 mm., from the anterior extremity.

Each branch of the dorsal ray of the bursa has, in addition to the two small terminal digitations, a small accessory branch on its outer surface. The spicules measure about 0.32–0.38 mm. in length. The barb of the left spicule is at 0.045–0.063 mm., that of the right at 0.063–0.072 mm., from the tip. The accessory piece is about 0.16–0.23 mm. long.

The tail of the female is rather blunt, and measures 0.17–0.32 mm. in length. The caudal papillæ are situated at 0.05–0.12 mm. from the tip. The vulva is at a distance of about 1.2–3.2 mm. from the posterior end, and opens on a posteriorly-directed appendage (the aperture being either at the extremity of the appendage or on either the dorsal or the ventral surface of it). The vagina runs anteriorly from the vulva and is 0.12–0.26 mm. long. The eggs measure 0.053–0.078 × 0.033–0.054 mm.

3. *Hæmonchus longistipes* Railliet and Henry, 1909.

Host :—This species is recorded by Railliet and Henry from the abomasum of the camel (*Camelus dromedarius*) in Africa and India. In the latter country it was originally

found by Leese, and has been recorded subsequently by Boulenger (1921, *b*) and by Baylis and Daubney (1923, *b*). Railliet and Henry state that "in the Indies this parasite is very common and appears to play a predominant pathogenic role in producing a chronic abomasitis." The brief description given by these authors has been considerably amplified by Boulenger, on the basis of material in the collection of the Punjab Veterinary College, Lahore.

The male measures 18–25 mm. in length and about 0.4 mm. in maximum thickness, the female 23–35 mm. and 0.45–0.65 mm. respectively. The diameter of the head is about 0.03 mm. The buccal tooth is 0.01 mm. long, and sometimes projects from the mouth. The œsophagus measures 1.6–2.1 mm. in length. The cervical papillæ are situated at 0.39–0.53 mm. from the anterior end.

The dorsal lobe of the bursa is relatively large, and the stem of the dorsal ray is at least twice as long as its branches. The spicules are 0.6–0.65 mm. long. The barb of the left spicule is at 0.038–0.04 mm., that of the right spicule at 0.09–0.1 mm., from the tip. The accessory piece measures 0.3–0.33 mm. in length.

The tail of the female is slender and pointed, and is 0.47–0.58 mm. long. The vulva is situated at 4.5–6.8 mm. from the posterior end, and is not covered by a flap. There is, however, a rounded projection of the body-wall on one side of it. The ovejectors have a combined length of 0.8–1.1 mm. The eggs measure 0.068–0.07 × 0.04–0.05 mm.

5. Genus **NEMATODIRUS** Ransom, 1907.

Body markedly tapering and thread-like anteriorly. Cuticle of anterior end slightly inflated. Cuticle of body with a number of longitudinal ridges. Cervical papillæ absent. Anterior end of œsophagus with a small dorsal and two still smaller subventral teeth. Lateral lobes of bursa typically bear on their inner surfaces a number of cuticular bosses. Dorsal lobe reduced to two small lobules, each supported by a separate ray. Ventral rays close together and parallel. Postero-lateral ray divergent distally from the other lateral rays. Spicules slender, relatively long, and united, at least distally, by a membrane. Accessory piece absent. Tail of female truncate, usually with a terminal spike. Vulva typically in the posterior region of the body. Eggs relatively large (generally over 0.15 mm. long). Adult worms parasitic in the stomach and small intestine of mammals, chiefly herbivores.

Genotype :—*Nematodirus filicollis* (Rud., 1802).

Key to Species.

Spicules of male less than 1 mm. long
 Spicules of male more than 4 mm. long.

flicollis, p. 380.
mauritanicus, p. 381.

1. ***Nematodirus flicollis*** (Rud., 1802) Ransom, 1907 (Fig. 179.)

Synonyms:—*Ascaris flicollis* Rudolphi, 1802; *Trichocephalus auricularis* Rudolphi, 1802 (nec *Strongylus auricularis* Zeder, 1800); *Fusaria flicollis* Zeder, 1803; *Strongylus flicollis* Rudolphi, 1803, nec Molin, 1861; *Æsophagostomum flicollis* Stossich, 1899; *Trichostrongylus flicollis* Sluiter and Swellengrebel, 1912; *Strongylus (Nematodirus) flicollis* Huttyra and Marek, 1913; *Nematodirus (Nematodirus) flicollis* Neveu-Lemaire, 1914.

Hosts:—This is a cosmopolitan parasite of the duodenum of ruminants (sheep, goat, ox, deer, chamois etc.) It has been recorded by Gaiger from the sheep in India.

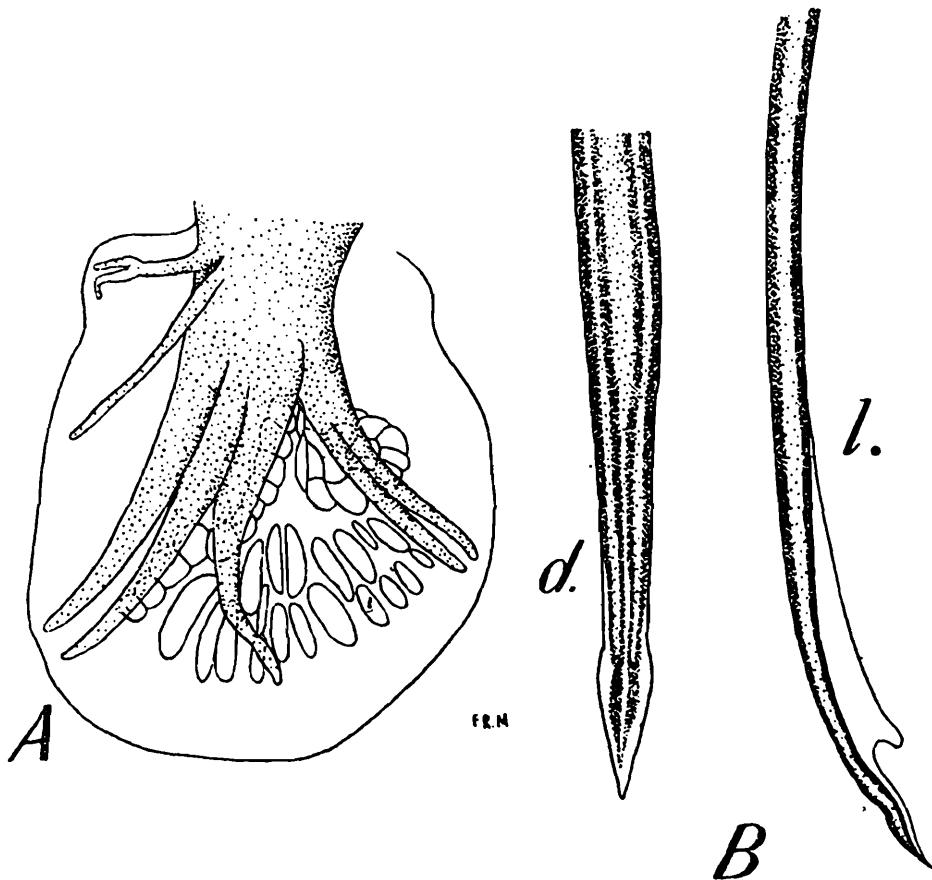

Fig. 179.—*Nematodirus flicollis*. A, bursa of male, lateral view; B, dorsal (*d.*) and lateral (*l.*) views of tip of spicule. (From Baylis, after May.)

The male measures about 7.5–15 mm. in length and 0.09–0.175 mm. in maximum thickness, the female about 12–21 mm. and 0.15–0.25 mm. respectively. The diameter of the head is 0.025–0.06 mm. In the cervical region there are coarse transverse striations. The rest of the body is without transverse striations, but has 18 longitudinal ridges. The œsophagus

measures 0.4–0.6 mm. in length. The nerve-ring is situated at about 0.3 mm. from the anterior end. The excretory pore is about 0.05–0.07 mm. behind the posterior end of the oesophagus.

The bursa of the male is large, and the bosses on its lining are relatively large and elongated. The dorsal lobes are not very distinct. The rays are comparatively slender. The spicules measure 0.68–0.95 mm. in length, and each has a sharply-pointed terminal portion.

The tail of the female is about 0.07–0.08 mm. long, and is truncate, but has a terminal filament measuring 0.012–0.018 mm. in length. The vulva is situated at about the posterior third of the body. The combined length of the ovejectors is about 0.4–0.5 mm. The eggs measure 0.13–0.2 × 0.07–0.09 mm.

2. *Nematodirus mauritanicus* Maupas and Seurat, 1912.

Synonym :—*Nematodirus spathiger* of Gaiger, 1910.

Host :—This species occurs in the small intestine of the camel (*Camelus dromedarius*), and was originally recorded and described from North Africa by Maupas and Seurat. Boulenger (1921, *b*), who examined specimens labelled *N. spathiger* in the collection of the Punjab Veterinary College (probably the specimens recorded by Gaiger), found them to be *N. mauritanicus*, and has added a few details to the description of the female. The fragmentary specimens from a camel recorded by Baylis and Daubney (1923, *b*) as *Nematodirus* sp. very probably belonged to this species.

The male measures about 13–15 mm. in length and 0.17 mm. in maximum thickness, the female 20–24 mm. and 0.35 mm. respectively. The cuticle of the head is slightly inflated and transversely striated. The diameter of the head in the male, according to Maupas and Seurat, is 0.06 mm., or 0.038 mm. without the cuticular inflation. The head of the female, according to Boulenger, has a diameter of about 0.035 mm. In the anterior region of the body the cuticle shows 24 to 28 longitudinal ridges. In the female the postvulvar region is without these, but has transverse striations at intervals of 1.5 μ . The buccal cavity is small and funnel-shaped. The oesophagus is about 0.58–0.61 mm. long, and is club-shaped posteriorly. The nerve-ring is situated behind the middle of the oesophagus, and the excretory pore a little behind its posterior end.

The dorsal lobes of the bursa are united, but separated from the lateral lobes by deep indentations. The spicules measure 4.5–5.5 mm. in length, and their terminal portions are shaped like spear-heads.

The tail of the female is about 0.1 mm. long, and is truncate, but has a terminal filament. The vulva is situated a little behind the middle of the body (at 9–10.5 mm. from the posterior end). The ovejectors run parallel to each other and posteriorly from the vulva, and are very unequal in size, one being about 3.2 mm., the other 1.44 mm. long. The eggs measure 0.22–0.28 × 0.09–0.115 mm. Their contents are sometimes only segmenting at the time of laying, but they may, according to Maupas and Seurat, already contain embryos.

6. Genus **MECISTOCIRRUS** Railliet and Henry, 1912.

Body markedly attenuated anteriorly. Anterior end with a slight vesicular swelling. Cuticle of body with numerous inconspicuous longitudinal ridges. Cervical papillæ conspicuous and spine-like. Mouth subterminal and slightly dorsal. Buccal cavity contains a large, lancet-like tooth. Bursa of male consists of two lateral lobes and a small but distinct dorsal lobe. Ventro-ventral ray short, slender and widely divergent from the latero-ventral ray. Latero-ventral and antero-lateral rays very stout, close together and parallel. The remaining rays are all slender. Dorsal ray short and bifurcate distally, each branch having three terminal papillæ. Prebursal papillæ present. Spicules very long, slender and united for almost the whole of their length. Accessory piece apparently absent. Vulva close to the anus, with prominent, chitinous lips. Vagina very long and running anteriorly from the vulva. Adult worms parasitic in the alimentary canal of mammals, chiefly ruminants.

Genotype :—*Mecistocirrus digitatus* (v. Linstow, 1906).

1. **Mecistocirrus digitatus** (v. Linstow, 1906) Railliet and Henry, 1912. (Fig. 180.)

Synonyms :—*Strongylus digitatus* v. Linstow, 1906; *Strongylus fordii* Daniels, 1908; *Strongylus gibsoni* Stephens, 1909; *Nematodirus digitatus* Railliet and Henry, 1909; *Nematodirus fordii* Leiper, 1911; *Nematodirus gibsoni* Railliet and Henry, 1912; *Nematodirus (Mecistocirrus) digitatus* Railliet and Henry, 1912; *Nematodirus (Mecistocirrus) fordii* Railliet and Henry, 1912; *Mecistocirrus fordii* Railliet and Henry, 1912; *Mecistocirrus fordii* Lane, 1916; *Mecistocirrus tagumai* Morishita, 1922.

Hosts :—This species has been recorded as a parasite of the stomach, and less commonly of the small intestine, of the zebu, ox, buffalo, sheep, pig and (accidentally) man in Eastern countries. It was originally recorded by v. Linstow from the stomach of the zebu (*Bos indicus*) at Colombo, Ceylon. The type-specimens, however, are apparently not now available in the Colombo Museum. Sheather (1919)

describes what was evidently this species from the fourth stomach of calves in a dairy herd in India, and states that the animals showed all the symptoms usually associated with parasitic gastritis, and that there could be no doubt that the worms were responsible for their death. Specimens from the abomasum of a calf, presumably of Indian origin, were also recorded by Baylis and Daubney (1923, *b*).

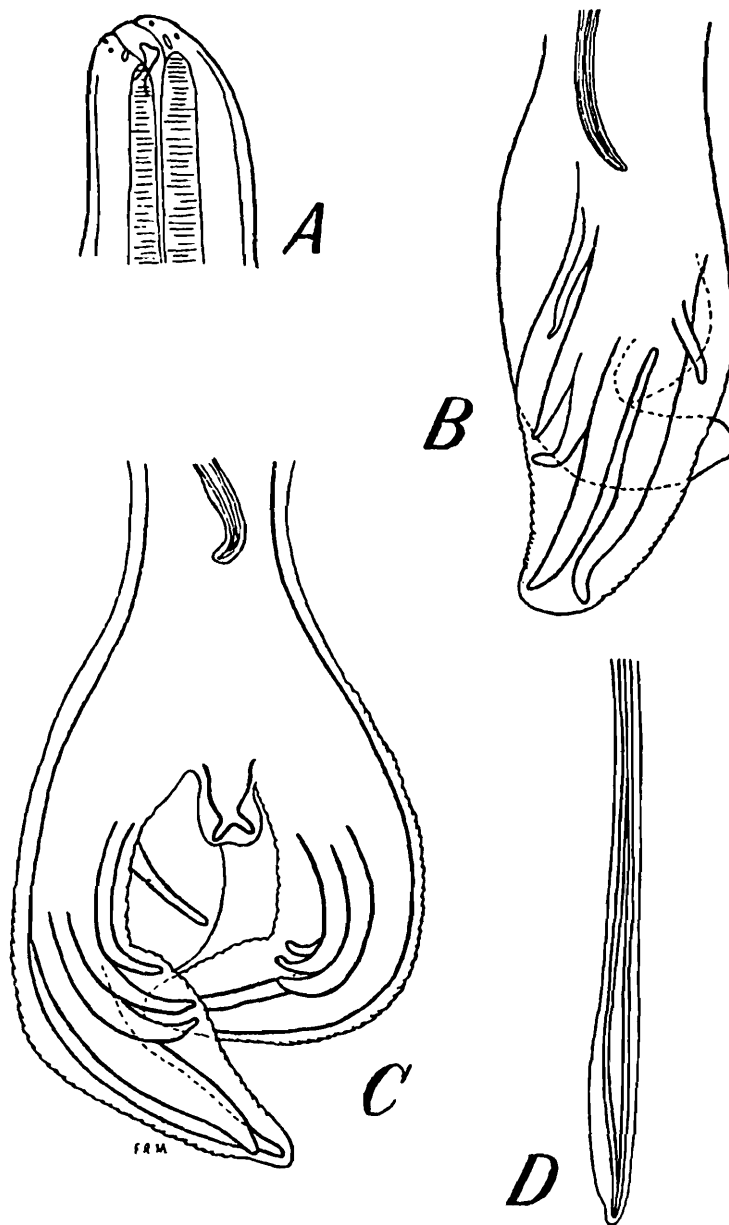

Fig. 180.—*Mecistocirrus digitatus*. A, anterior end, lateral view; B, bursa of male, lateral view; C, bursa, dorsal view; D, tip of spicules. (From Baylis, after Yorke and Maplestone.)

This species is very variable in size. The male measures about 16–31 mm. in length and 0.36–0.4 mm. in maximum thickness, the female 19–43 mm. and 0.47 mm. respectively. The cuticle has fine transverse striations, the intervals between

which measure not more than 2μ , and about 30 longitudinal ridges. The œsophagus is club-shaped and about 1.6–1.8 mm. long. The cervical papillæ are situated at about 0.5 mm. from the anterior end, the nerve-ring at about the anterior quarter of the œsophagus, and the excretory pore behind the nerve-ring.

The spicules measure 3.8–7 mm. in length.

The tail of the female is pointed and about 0.14–0.2 mm. long. The vulva is situated at 0.26–0.6 mm. from the posterior end, and the vagina is about 2.8 mm. long. The ovejectors are opposed, but the posterior branch of the uterus immediately turns forward to run parallel with the anterior branch. The eggs measure $0.095\text{--}0.12 \times 0.05\text{--}0.06$ mm.

7 Genus **OSWALDOCRUZIA** Travassos, 1917

Cuticle of anterior end inflated and transversely striated. Ventral rays of bursa close together and equal in size. Antero-lateral ray divergent from, and of about the same length as, the other lateral rays, which are closely apposed. Externodorsal rays originate from the base of the dorsal ray and are parallel proximally to the trunks of the lateral rays, but diverge from the postero-lateral rays distally. Dorsal ray long and rather stout, cleft distally, with two pairs of small accessory branches and several short terminal digitations. Accessory piece absent. Eggs contain embryos when deposited. Adult worms parasitic in the intestine or lungs of reptiles and batrachians.

Genotype :—*Oswaldocruzia subauricularis* (Rud., 1819).

1. **Oswaldocruzia filiformis** (Goeze, 1782) Travassos, 1917

Synonyms :—*Ascaris filiformis* Goeze, 1782; *Ascaris tenuissima* Schrank, 1788; *Ascaris intestinalis* Gmelin, 1790; *Ascaris bufonis* Gmelin, 1790, nec Schrank, 1788; *Cucullanus ranæ* Gmelin, 1790; *Strongylus auricularis* Zeder, 1800.

Hosts :—This parasite has been recorded from the intestine of a number of species of frogs, toads, newts, salamanders and lizards in Europe. Baylis and Daubney (1923, *b*) record it from *Bufo melanostictus* at Nankouri, Nicobar Islands.

The male measures about 10 mm. in length and 0.18 mm. in maximum thickness, the female 11–19 mm. and 0.2–0.25 mm. respectively. The cuticular striations are at intervals of about 2.3μ . The diameter of the head, including the cuticular inflation, is about 0.06 mm., or without the inflation 0.05 mm. The œsophagus is club-shaped and measures about 0.6 mm. in length and 0.065 mm. in maximum width.

The spicules of the male are about 0.23 mm. long, and are divided distally into four or five points, two of which are bifid.

The tail of the female measures 0.5–0.7 mm. in length, and is truncate, but has a terminal filament. The vulva is prominent, and is situated at about the posterior fifth or quarter of the body. The eggs measure about 0.09–0.12 mm. in length.

APPENDIX TO TRICHOSTRONGYLINÆ.

Strongylus costatus Meyer, 1896.

Host :—Indian pangolin (*Manis pentadactyla*) ; Ceylon.

This species is not sufficiently fully described to enable its systematic position to be determined, but appears to belong to the subfamily Trichostrongylinæ, and is possibly closely related to the genus *Trichohelix* Ortlepp, 1922.

The male, according to Meyer's description, measures 9.2–10 mm. in length and 0.08–0.1 mm. in maximum thickness, the female 10.5–11.7 mm. and 0.11–0.14 mm. respectively. The cuticle of the head is inflated, and that of the body bears about 26 longitudinal ridges. A pair of lateral alæ, which are somewhat T-shaped in transverse section, extend throughout almost the whole length of the body. A "chitinous mouth-ring" is said to be present. The œsophagus is 0.5 mm. long, and the excretory pore is situated at 0.03 [?] mm. from the anterior end.

The bursa of the male measures 0.12–0.14 mm. in length and 0.11–0.13 mm. in width. The spicules are tubular, and are hooked at their tips. They measure 0.15 mm. in length and 0.02 mm. in thickness.

The tail of the female is 0.11–0.12 mm. long, and is bluntly rounded, but has a terminal filament 0.015 mm. long. The vulva is situated at 2 mm. from the posterior end, and the vagina is very short. The uterine branches are opposed, and each has a globular swelling ("seminal vesicle") at a distance of 0.3–0.4 mm. from the vagina. The eggs measure 0.072–0.076 × 0.037–0.043 mm.

17. Family METASTRONGYLIDÆ Leiper, 1908.

Synonyms :—Pseudaliidæ Railliet, 1916 ; Protostrongylidæ Leiper, 1926.

Buccal capsule much reduced or absent. Bursa of male may be relatively well developed or vestigial, with a corresponding degree of development of the bursal rays, some of which, in extreme cases, may be reduced to mere papillæ. Parasites of the respiratory and circulatory systems, and of the cranial sinuses, of mammals.

This family, as here understood, comprises the "lungworms" not only of terrestrial mammals, but also of Cetaceà and Pinnipedia. There appears to the writer to be no necessity for the erection of a separate family (Pseudaliidæ) for the lungworms of marine mammals. The differences between the genera are for the most part merely degrees of reduction in the bursal rays and in the bursa itself, and it is difficult to find characters to justify the various subfamilies into which certain authors have proposed to divide the group.

The family includes several forms which are of some importance as causing disease (verminous bronchitis and pneumonia) in domestic animals. The life-history of most of the genera is still unknown, but it has recently been discovered that some of the forms occurring in domestic animals may make use of invertebrates as intermediate hosts. It is not yet clear, however, that an intermediate host is indispensable for any of them. Some are known to have a direct development in the open, while it may be strongly suspected that with others (even among those which sometimes pass through an intermediate host) prenatal infection can occur. It appears extremely probable that in the case of marine hosts this is the general rule.

Key to Genera.

- | | |
|--|------------------------------|
| Adult worms (imperfectly described) in nodules in the respiratory organs of dogs. | OSLERUS, p. 395. |
| Bursa of male with two separate dorsal rays. | 1. |
| Bursa with a single stout dorsal ray having short terminal digitations | 2. |
| 1. Dorsal rays with simple terminations; spicules of male long and slender, with hooked tips | [p. 387.
METASTRONGYLUS, |
| Dorsal rays with bidigitate or tridigitate terminations; spicules short and stout | DICTYOCAULUS, p. 389. |
| 2. Posterior end of male with a bow-shaped chitinoid supporting structure | [p. 394.
PROTOSTRONGYLUS, |
| Posterior end of male apparently without bow-shaped supporting structure | [p. 392.
VARESTRONGYLUS, |

1. Genus **METASTRONGYLUS** Molin, 1861.

Mouth with two lateral trilobed lips. Bursa small; its greatest diameter antero-posterior, and its wall thickened in the posterior half. All the bursal rays very stout, except the dorsal and externo-dorsal, which are small and thin. Tip of latero-ventral ray curves away from ventro-ventral ray. Termination of antero-lateral ray typically forms a large, lobulated swelling. Postero-lateral ray represented by a small branch arising from the medio-lateral ray. The latter may also have a swollen termination. Spicules long and slender, each with a striated ala and ending in a single hook. Posterior end of female recurved ventrally. Vulva immediately in front of anus. Uterine branches parallel. Eggs contain embryos when laid. Adult worms parasitic in the respiratory passages of Suidæ and, accidentally, of other mammals.

Genotype:—*Metastrongylus elongatus* (Duj., 1845).

1. **Metastrongylus elongatus** (Duj., 1845) Railliet and Henry, 1911. (Fig. 181.)

Synonyms:—*Ascaris apri* Gmelin, 1790 (part); *Ascaris bronchiorum suis* Modeer, 1791; *Fusaria apri* Zeder, 1803 (part); *Gordius pulmonalis apri* Rudolphi, 1809 (part); *Strongylus suis* Rudolphi, 1809 (part); *Strongylus paradoxus* Mehlis, 1831 (part); *Strongylus elongatus* Dujardin, 1845; *Strongylus longevaginatus* Diesing, 1851; *Metastrongylus longevaginatus* Molin, 1861; *Metastrongylus paradoxus* Molin, 1861; *Eustrongylus longevaginatus* Duglison, 1874; *Strongylus apri* Blanchard, 1895; *Cloacina octodactyla* v. Linstow, 1906; *Sclerostoma apri* Braun and Lühe, 1910; ? *Filaria trachealis* Cobbold, 1864.

Hosts:—This species occurs in the bronchioles, and more rarely in the bronchi and trachea, of the pig, wild boar and peccary. It is also occasionally recorded in man, the dog and various ruminants (cattle, sheep, goat and deer). In pigs it gives rise to a verminous bronchitis, sometimes leading to pneumonia, which may be fatal to young animals. The parasite is of world-wide distribution. Baylis and Daubney (1923, b) record fragmentary material of this species, from the bronchi of a pig, in the collection of the Zoological Survey of India, but it is uncertain whether the specimens were of Indian origin.

The male measures 11–25 mm. in length and 0.1–0.225 mm. in maximum thickness, the average thickness, according to Lewis (1926), being 0.14 mm. The female measures 12–58 mm. and 0.4–0.45 mm. respectively. The œsophagus is 0.5–0.63 mm. long.

The dorsal ray of the bursa consists of two separate portions. The male has a well-developed genital cone. The spicules

are equal or subequal in length, and measure 2.5–5 mm. There is no accessory piece.

The posterior end of the female is often bent ventrally into a hook. The tail is 0.09 mm. long and is suddenly narrowed, with its tip curved ventrally. The vulva is close to the anus and is preceded by a prominent swelling. The vagina is about 2.3 mm. long. The eggs have an average size of about 0.051×0.035 mm., though measurements up to 0.1×0.073 mm. have been recorded.

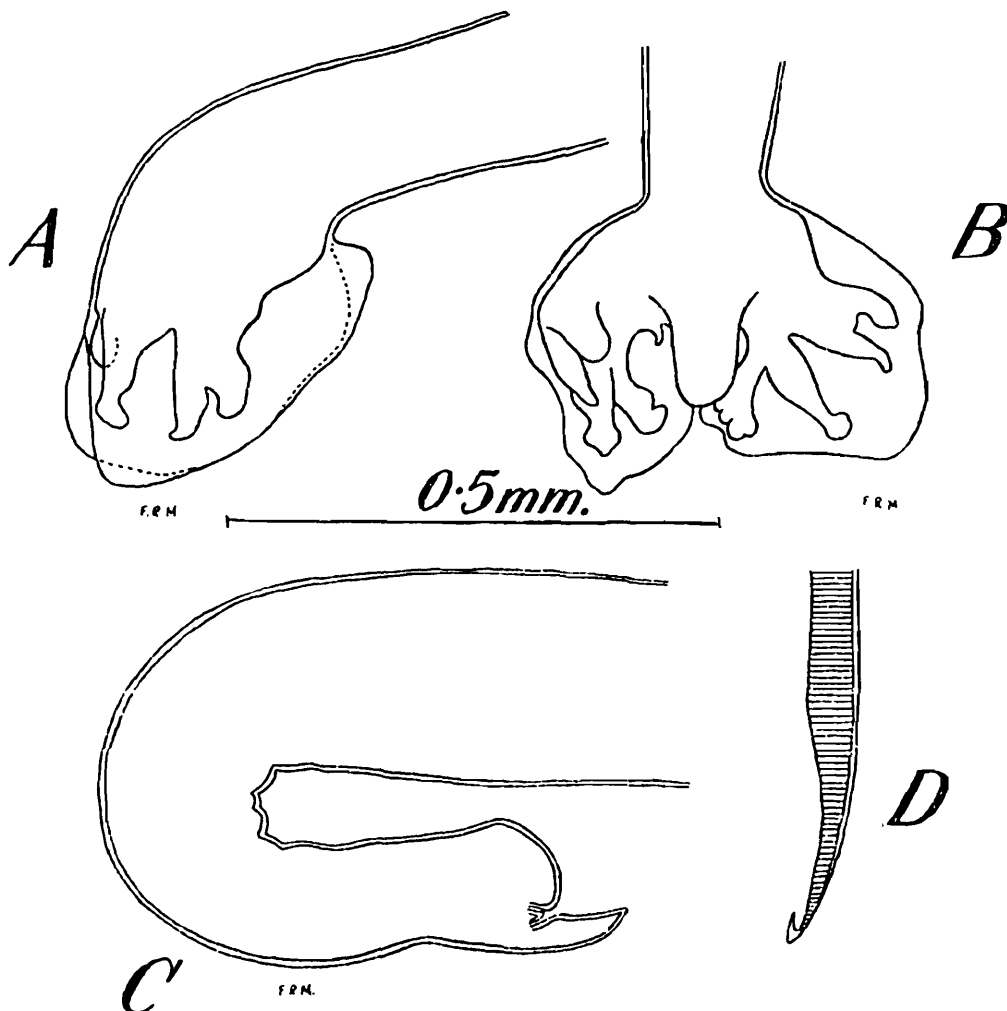

Fig. 181.—*Metastrongylus elongatus*. A, bursa of male, lateral view; B, bursa, ventral view; C, posterior end of female, lateral view; D, tip of spicule. (The scale refers to the figures above it.) (From Baylis, after Gedoelst.)

The life-history of this species, according to recent researches by Hobmaier and Hobmaier, Schwartz and Alicata, and others, is briefly as follows. The eggs, which contain embryos when laid, hatch in the bronchi of the host. The larvæ, on reaching the ground with the fæces, are swallowed by earthworms (species of *Lumbricus* and *Helodrilus*). They enter the blood-vessels of the worms, and there continue their development, undergoing two moults. The third (infective) stage is reached

in about a week or ten days. Pigs may become infected by swallowing earthworms, but it has been found that the infective larvæ are capable of living for about two weeks after the death of the earthworm. It appears, therefore, that they may also be picked up from the soil. On reaching the intestine of the final host, the larvæ migrate to the lungs, where they reach the fourth stage in about five days, and become sexually mature within a period varying from three to eight weeks after infection. There seems to be a possibility that prenatal infection may occur, since pigs only three weeks old have been found to be infested.

2. Genus **DICTYOCAULUS** Railliet and Henry, 1907.

Mouth surrounded by four lip-like structures, two lateral and larger than the other two, which are dorsal and ventral. A very shallow buccal capsule present, with a chitinous ring at its base. Bursa of male short. Antero-lateral ray originates separately from the other lateral rays. Medio-lateral and postero-lateral rays fused, at least for the greater part of their length. Externo-dorsal rays originate separately from the dorsal ray, which consists of two separate portions with bidigitate or tridigitate terminations. Spicules short, stout and simple, showing a reticulate structure. An accessory piece present. Vulva near the middle of the body. Uterine branches opposed. Eggs contain embryos when laid, and may be without chitinous shells. Adult worms in the bronchi of herbivorous mammals.

Genotype :—*Dictyocaulus filaria* (Rud., 1809).

Key to Species.

Parasite of horse tribe and tapir	<i>arnfieldi</i> , p. 392.
Parasites of ruminants	1.
1. Spicules of male between 0.3 mm. and 0.6 mm. long	<i>filaria</i> , p. 389.
Spicules of male less than 0.3 mm. long	2.
2. Spicules about 0.2 mm. long	<i>viviparus</i> , p. 391.
Spicules only slightly less than 0.3 mm. long	<i>unequalis</i> , p. 391.

1. **Dictyocaulus filaria** (Rud., 1809) Railliet and Henry, 1907. (Fig. 182).

Synonyms :—*Strongylus filaria* Rudolphi, 1809 ; *Sclerostoma filaria* Braun and Lühe, 1910 ; ? *Strongylus dorcadis* Rudolphi, 1819.

Hosts :—This species occurs in the sheep, goat and camel, and is of cosmopolitan distribution. It occurs also in various wild ruminants (deer, chamois, etc.). According to Gaiger (1910 ; 1915), this parasite is very common in sheep on marshy land and near rivers in India. It is recorded also by him

from the camel in the Punjab. This worm is the common cause of verminous bronchitis ("husk" or "hoose") in heavily-infested animals.

The male measures about 30–80 mm. in length and 0.4 mm. in maximum thickness, the female about 50–100 mm. and 0.45 mm. respectively. The head is blunt, and has a diameter of about 0.12 mm. The œsophagus is club-shaped, and measures 1.25–1.4 mm. in length and about 0.09–0.13 mm. in maximum width.

The spicules of the male measure about 0.32–0.57 mm. in length, and are relatively broad, alate and somewhat boomerang-shaped. They are of a dark brown colour and have pitted or reticulate surfaces.

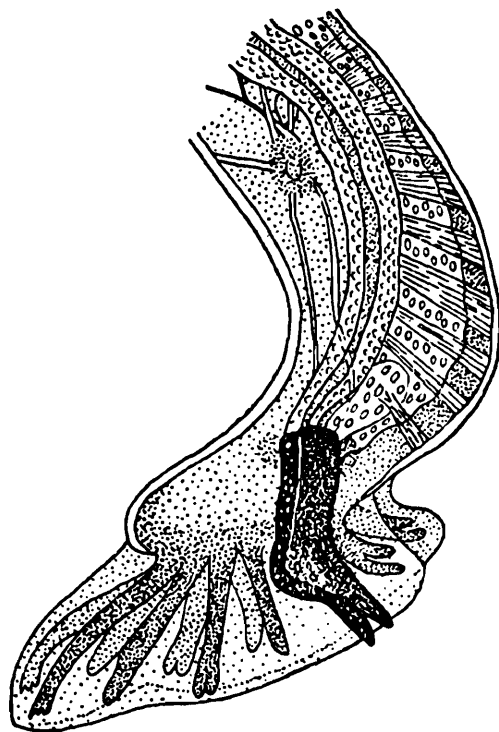

F.R.M.

Fig. 182.—*Dictyocaulus filaria*. Posterior end of male; lateral view. (From Baylis, after Neveu-Lemaire.)

The tail of the female is pointed and measures about 0.47 mm. in length. The vulva has rather prominent lips, and is situated at about the posterior $\frac{2}{5}$ of the body. The eggs measure 0.116–0.138 × 0.069–0.09 mm.

The life-history of this species, briefly described, is as follows. The eggs hatch in the lungs of the host, and the first-stage larvæ are swallowed and passed in the fæces. They undergo the first moult about a day after hatching, but the cuticle is retained until the second moult. This occurs in about six to ten days, according to temperature, and the third (infective) stage is thus reached. In this stage the worm may live in the open for about six months, and is very resistant to drying and low temperatures. It is unable to penetrate the host's

skin, but direct infection takes place if the larva is swallowed with food or water. When the atmosphere is sufficiently damp, the larvæ climb up on the grass, especially during the night or if the weather is dull but warm. Within three days after being ingested by a suitable host the larva enters the lymphatics of the intestinal wall, and thence invades the mesenteric lymphatic glands. Here it undergoes a further moult about four or five days after infection. By about the tenth day the fourth-stage larva migrates to the lungs and enters the bronchioles, where the last moult occurs. Sexual maturity is reached within about six weeks from the time of infection. Young animals may be infected prenatally.

2. *Dictyocaulus unequalis* Bhalerao, 1932.

Host :—This species is recorded by Bhalerao from the bronchi of a Tibetan sheep (*Ovis hodgsoni*) at Muktesar, United Provinces. The animal had been suffering from pneumonia.

There are very few characters in Bhalerao's description which show a clear distinction from *D. filaria*. The smaller size of the spicules of the male, and the position of the vulva in the female, however, may prove to be valid specific characters when further specimens are obtained.

The male measures, according to Bhalerao, 28 mm. in length and 0.3 mm. in maximum thickness, the female 64 mm. and 0.43 mm. respectively. The buccal capsule measures 0.017–0.018 mm. in length and 0.023–0.032 mm. in width. The œsophagus is 1.1 mm. long in the male and 1.23–1.37 mm. in the female. The nerve-ring, in the male, is situated at 0.23 mm. from the anterior end.

The bursa is 0.28 mm. wide. The spicules are reticulate and measure 0.28–0.29 mm. in length. The accessory piece is 0.1 mm. long.

The tail of the female is 0.57 mm. long. The vulva has prominent lips and is situated at 29 mm. from the anterior end (*i. e.* somewhat in front of the middle of the body). The eggs measure 0.1–0.123 × 0.061–0.073 mm.

3. *Dictyocaulus viviparus* (Bloch, 1782) Railliet and Henry, 1907.

Synonyms :—*Gordius viviparus* Bloch, 1782; *Ascaris vituli* Gmelin, 1790; *Fusaria vituli* Zeder, 1803; *Strongylus vitulorum* Rudolphi, 1809; *Strongylus micrurus* Mehlis, 1831; *Metastrongylus micrurus* Sluiter and Swellengrebel, 1912; *Dictyocaulus micrurus* Railliet, 1915; ? *Strongylus pulmonaris* Ercolani, 1859.

Hosts :—This species is a cosmopolitan parasite of the bronchi of cattle and deer, and frequently has effects similar

to those of *D. filaria*. It has been recorded from the ox in the Punjab by Gaiger.

The male measures about 40 mm. in length, the female about 60–80 mm. The medio-lateral and postero-lateral rays of the bursa are entirely fused. The spicules are 0.195–0.215 mm. long. The vulva is situated in the posterior quarter of the body. The eggs measure 0.082–0.088 × 0.033–0.038 mm.

The life-history of this form is similar to that of *D. filaria*, but the larvæ may reach the infective stage in the open in as short a period as four days.

4. *Dictyocaulus arnfieldi* (Cobbold, 1884) Railliet and Henry, 1907.

Synonyms :—*Strongylus arnfieldi* Cobbold, 1884; *Metastrongylus arnfieldi* Sluiter and Swellengrebel, 1912; *Strongylus (Dictyocaulus) arnfieldi* Hutyrá and Marek, 1913.

Hosts :—This species is a parasite of the horse and donkey in Europe and elsewhere. It has also been recorded from the Malay tapir (*Tapirus indicus*) in France by Railliet and Henry. Gaiger records its occurrence in a horse in the Punjab.

The male measures 25–36 mm. in length and about 0.25 mm. in maximum thickness, the female 43–60 mm. and about 0.4 mm. respectively. The œsophagus is club-shaped and measures, in the female, about 0.75 mm. in length and 0.15 mm. in maximum width. The nerve-ring is situated at about the middle of the œsophagus, and the excretory pore just behind the nerve-ring.

The ventral rays of the bursa are fused for the greater part of their length, as are also the medio-lateral and postero-lateral rays. The antero-lateral ray is separate from, but close to, the other lateral rays. The dorsal ray has a main stem and two simple terminal branches. The spicules are somewhat club-shaped and measure about 0.2–0.25 mm. in length. They have a vacuolated structure. The accessory piece is about 0.05 mm. long.

The tail of the female is about 0.4 mm. long, and is bluntly pointed. The vulva is situated just in front of the middle of the body. The eggs measure 0.08–0.1 × 0.05–0.06 mm.

3. Genus **VARESTRONGYLUS** Bhalerao, 1932.

Mouth surrounded by four lip-like structures, two lateral and larger than the others, which are dorsal and ventral. Bursa small. Ventral rays stout and fused except at the tips. Lateral rays relatively slender. Antero-lateral and medio-lateral rays widely divergent. Postero-lateral ray represented

by a small branch arising from the medio-lateral ray. Externodorsal rays originate independently of the dorsal ray, which consists of a stout trunk with short terminal digitations. Spicules fairly stout, bifid distally and provided with striated alæ. A gubernaculum and a telamon present; the latter said to consist of two chitinous structures with a swelling at their base. Vulva close to anus, covered by a cuticular flap. Uterine branches parallel. Oviparous. Adult worms parasitic in the bronchi of ruminants.

Genotype :—*Varestrongylus pneumonicus* Bhalerao, 1932.

1. *Varestrongylus pneumonicus* Bhalerao, 1932.

Hosts :—This species is recorded by Bhalerao from the bronchi of the Himalayan ibex (*Capra sibirica*), great Tibetan sheep (*Ovis hodgsoni*) and "hill sheep" (Bharal or blue wild sheep, *Ovis nahura*) at Muktesar, United Provinces.

The male measures 17.6–24 mm. in length and about 0.17–0.19 mm. in maximum thickness, the female 19.6–28 mm. and about 0.18–0.19 mm. respectively. The cuticle appears smooth. The buccal cavity is very feebly developed or absent. The œsophagus is club-shaped and measures 0.34–0.4 mm. in length. The nerve-ring is situated at 0.17–0.18 mm. from the anterior end of the œsophagus in the male, and at 0.19–0.25 mm. from the same point in the female. The excretory pore is at the level of the nerve-ring or somewhat behind it.

The bursa of the male has relatively large lateral lobes and a small dorsal lobe. The dorsal ray is stout and ends in five digitations. The externodorsal rays do not reach the edge of the bursa. The postero-lateral ray is very small, and originates as a branch of the medio-lateral ray. The antero-lateral ray arises separately from the medio-lateral and diverges widely from it, reaching the edge of the bursa. The ventral rays are stout and are fused for the greater part of their length. The spicules measure 0.29–0.57 mm. in length. They are provided, on their inner surfaces, with transversely-striated alæ which overlap in the middle portion. The tips of the spicules are bifid. There is a somewhat spindle-shaped gubernaculum, which "has two pairs of lateral processes, one situated at the extreme posterior end is very short and the other, which is about three times as long as the first, is situated at a distance of about 0.02 [mm.] in front of the former. Besides the gubernaculum there are two chitinous structures with a swelling at their base which form the telamon. It measures 0.026–0.027 [mm.] in length."

The tail of the female tapers rapidly to a point and measures 0.04–0.045 mm. in length. The vulva is situated at a distance

of 0.04–0.06 mm. from the anus, and has prominent lips. “Inserted immediately anterior to the vulva and disposed posteriorly is a cuticular valve measuring 0.065–0.08 [mm.] in length. It covers the vulva and the anus ventrally.” The vagina is about 1.41 mm. long. The eggs have very thin shells and measure 0.057–0.08 × 0.03–0.043 mm.

4. Genus **PROTOSTRONGYLUS** Kamensky, 1905.

Synonym :—*Synthetocaulus* Railliet and Henry, 1907.

Very slender forms, reddish during life. Posterior end of body in male has a bow-shaped chitinoid supporting structure. Lateral rays of bursa originate from a common trunk. Medio-lateral and postero-lateral rays parallel and partly fused. Externo-dorsal rays originate separately from the dorsal ray. The latter consists of a stout trunk with short terminal digitations. Spicules rather stout, striated or pectinate, and simple or divided distally into two processes. Paired accessory pieces and a telamon present; the former consisting of elongate and parallel chitinoid structures. Vulva close to the anus. Uterine branches parallel. Eggs unsegmented when laid. Adult worms parasitic in the smaller bronchioles and in the tissues of the lungs of mammals.

Genotype :—*Protostrongylus commutatus* (Diesing, 1851).

1. **Protostrongylus rufescens** (Leuckart, 1865) Kamensky, 1905.

Synonyms :—*Strongylus rufescens* Leuckart, 1865; *Synthetocaulus rufescens* Railliet and Henry, 1907; *Sclerostoma rufescens* Braun and Lühe, 1910; *Metastrongylus rufescens* Sluiter and Swellengrebel, 1912; *Strongylus (Synthetocaulus) rufescens* Huttyra and Marek, 1913; *Dictyocaulus rufescens* Pratt, 1916.

Hosts :—This parasite occurs in the bronchioles and pulmonary tissue of the sheep and goat, and also of certain wild hosts, such as the roe and fallow deer, and possibly the rabbit. Gaiger records it from sheep and goats in the Punjab. Verminous pneumonia is a frequent result of heavy infestation with this worm.

The following description is largely taken from Cameron (1927). The male measures 16–28 mm. in length, the female 25–35 mm. Cameron gives 17.5 mm. as the average length of the male, and 26 mm. as that of the female. The maximum thickness varies between 0.12 mm. and 0.2 mm. The cuticle is apparently unstriated. The mouth is surrounded by six very low papillæ. The œsophagus is about 0.25 mm. long, and has a maximum thickness of 0.04 mm. It is very slightly swollen posteriorly. The excretory pore and nerve-ring are situated just in front of this swelling. The cervical

papillæ are minute, and are situated at about the middle of the œsophagus. There are very long and conspicuous cervical glands, which extend for about one-sixth of the length of the body.

The body of the male is truncate posteriorly, and has two stout, crescentic, dorso-lateral cuticular plates which serve as supports for the bursal membrane. The ventral rays are short, but reach the margin of the bursa. The antero-lateral ray is shorter than the other lateral rays, all three of which are close together. The externo-dorsal rays terminate some distance from the edge of the bursa. The dorsal ray is represented by a spherical mass, on the inner surface of which there are six papillæ (three posterior, two median and one anterior). The spicules measure about 0.24–0.265 mm. in length. Each consists of “a central cuticular tube and a voluminous spicular sheath,” and ends in a blunt point surrounded by a colourless cuticle. “From the ventral aspect of each spicule arise two series of digitations which carry the spicular sheath: the median row of digitations are relatively long, whereas the lateral row is short. These digitations are finely granular, are of irregular shape and often bifurcate.” The accessory pieces (termed by Cameron the telamon) are about 0.05–0.06 mm. long, and are partly fused anteriorly. Their hinder portions are pigmented and carry four or five blunt teeth on their inner surfaces distally. The telamon (“gubernaculum” of Cameron) is situated at about 0.3 mm. from the cloacal opening, and consists of “a flat arc-shaped plate of a dark brown colour with its concave side on the posterior aspect. Attached to the ventral surface is a central keel which often bifurcates distally, and on either side of which pass the spicules.”

The tail of the female is bluntly pointed. It is about 0.06 mm. long, and bears a pair of small papillæ. The vulva is situated at about 0.15 mm. from the posterior end. The vagina is about 0.6 mm. long. The eggs measure 0.075–0.12 × 0.045–0.082 mm.

5. Genus **OSLERUS** Hall, 1921.

The genotype of this genus is so imperfectly known that it is almost impossible at present to draw up a generic diagnosis. Skrjabin (1933) regards *Oslerus* as a subgenus of *Filaroides* v. Beneden, 1858. The position of the vulva and the arrangement of the female genital tubes in *Oslerus* appear to be in marked contrast with the corresponding structures in the genotype of *Filaroides*, while many of its other important characters have not been adequately described. The writer feels, therefore, that the wisest course for the present is to treat *Oslerus* as an independent genus.

1. *Oslerus osleri* (Cobbold, 1879) Hall, 1921.

Synonyms :—*Strongylus canis bronchialis* Osler, 1877 ; *Filaria osleri* Cobbold, 1879 ; *Pseudalius osleri* Railliet, 1915 ; *Filaroides osleri* Skrjabin, 1933.

Hosts :—This parasite occurs in nodules under the mucous membrane of the trachea and bronchi, and apparently also in the lung-tissue, of dogs, each nodule containing several worms. It has been recorded also from the coyote or prairie wolf (*Canis latrans*) in North America. Gaiger has recorded it from dogs in India.

The male measures 4–5 mm. in length, and is very slender. The female is stouter and 6–15 mm. long. The tail of the male is rather blunt, and bears a pair of fleshy papillæ near the cloacal aperture. The spicules are slightly unequal, measuring 0·048 mm. and 0·056 mm. in length.

The tail of the female is rounded. The vulva is situated very close to the anus. The eggs are said to hatch in the uterus.

ALPHABETICAL INDEX.

[Names printed in *italics* are synonyms. Page-numbers printed in heavy type are main references.]

- Acanthopharynx*, 243.
acanthura (*Oxyuris*), 195.
 aceti (*Anguillula*), 16.
Actinolaimus, 234.
acutocaudatus (*Tylenchus*), 228.
acutum (*Esophagostomum*), 296.
additicia (*Decrusia*), 252.
additicus (*Strongylus*), 252.
additictia (*Decrusia*), 252.
additictus (*Strongylus*), 252.
Adoncholaimus, 241.
ægyptiacum (*Trichonema*), 269.
Africana, 149.
africanus (*Necator*), 327.
agile (*Multicæcum*), 100.
agilis (*Ascaris*), 100.
Agriostomum, 324.
Alaimidæ, 240.
alatus (*Thelandros*), 192.
Alfortia, 250.
Allantonema, 17.
Allodapa, 150.
Allomonhystera, 236.
ambiguus (*Passalurus*), 206.
americana (*Uncinaria*), 327.
americanum (*Anchylostomum*), 327.
americanum (*Ankylostomum*), 327.
americanus (*Necator*), 327.
- Amidostomidæ*, 356.
Amidostomum, 356.
Amira, 282.
Amiroides, 282.
ammonis (*Strongylus*), 296.
Amplicæcum, 105.
amucronatum (*Characostomum*), 328.
amucronatus (*Globocephalus*), 328, 329.
anatinum (*Amidostomum*), 357.
anatinum (*Epomidio-stomum*), 360.
anchylostomum (*Dochmius*), 318.
Ancylostoma, 7, **317**.
Ancylostomidæ, 5, **317**.
Ancylostominæ, 317.
andersoni (*Ascaris*), 151.
andersoni (*Subulura*), 151.
Angiostoma, 214.
Angiostomum, 214.
Anguillula aceti, 16.
Anguillulina, 226.
Anguillulinidæ, 9, 16, **225**.
Anguillulininæ, 225.
Anguina, 226.
angusta (*Anguillulina*), 229.
angusticolle (*Porrocæcum*), 71.
angusticollis (*Ascaris*), 71.
angustus (*Tylenchus*), 229.
Anisakinæ, 9, **66**.
annandalei (*Zanclophorus*), 174.
- anoura* (*Ascaris*), 49.
anoura (*Polydelphis*), 49.
Antholaimus, 234.
anthropopitheci (*Enterobius*), 191.
anthropopitheci (*Oxyuris*), 191.
apiostomum (*Esophagostomum*), 300.
Aphelenchulus, 226.
Aplectana, 200.
apri (*Ascaris*), 387.
apri (*Fusaria*), 387.
apri (*Sclerostoma*), 387.
apri (*Strongylus*), 387.
aquillæ (*Ascaris*), 83.
arcuata (*Kathleena*), 81.
ardeæ (*Ascaris*), 73, 74.
ardeæ (*Porrocæcum*), 73.
arenaria (*Anguillula*), 232.
arenarius (*Tylenchus*), 232.
armatum (*Piguris*), 248.
armatus (*Strongylus*), 248.
armatus major (*Strongylus*), 248.
arnfieldi (*Dictyocaulus*), 392.
arnfieldi (*Metastrongylus*), 392.
arnfieldi (*Strongylus*), 392.
Ascaridæ, 5, 17, 24, **34**.
Ascaridia, 133.
Ascarinæ, 35.
Ascaris, 3, 7, 17, 21, **35**.
Ascaris sp., 43.
Ascaroidea, 33, **34**.
Asifia, 259.

- asininus* (*Strongylus*), 248.
asperum (*Œsophagostomum*), 297.
Atractidæ, 206.
Atractis, 207.
attenuata (*Ascaris*), 49, 51.
attenuata (*Polydelphis*), 51.
Atylenchus, 226.
auricularis (*Trichocephalus*), 380.
auricularis (*Strongylus*), 384.
Austronema, 236.
Axonchium, 234.
- balisticola* (*Ascaris*), 95.
balistis (*Ascaris*), 92.
balistis (*Contracæcum*), 92.
balsami (*Dochmius*), 320.
barbata (*Urolabes*), 239.
barbatum (*Symplocostoma*), 239.
barbatus (*Enoplus*), 239.
barbi (*Falcaustra*), 165.
barbi (*Spiro-noura*), 165.
Bathmostomum, 343.
baylisi (*Thelandros*), 194.
Belanisakis, 66.
Belascaris, 58.
bengalensis (*Kalicephalus*), 347.
beramporia (*Heterakis*), 119, 122.
bifaria (*Ascaris*), 36.
biformis (*Tylenchus*), 228.
biramosum (*Œsophagostomum*), 306.
blanchardi (*Œsophagostomum*), 300, 302.
bosia (*Heterakis*), 116.
Bosicola, 291, 305.
boulengeri (*Pseudamidostomum*), 359.
Bourgelatia, 288.
Bourgelatioides, 305.
bovis (*Bunostomum*), 334.
bovis (*Œsophagostomum*), 306.
- brachycephalus* (*Kalicephalus*), 350.
brachycheilos (*Ascaris*), 52.
brachycheilos (*Polydelphis*), 52.
brachyura (*Ascaris*), 109.
brachyurus (*Tylenchus*), 230.
braziliense (*Agchylostoma*), 321.
braziliense (*Ancylostoma*), 319, 321.
braziliense (*Ancylostomum*), 321.
braziliense (*Ankylostoma*), 321.
braziliensis (*Uncinaria*), 321.
brevicauda (*Triodontophorus*), 255.
brevicaudatus (*Crossocephalus*), 210.
brevicaudum (*Œsophagostomum*), 294.
brevispiculata (*Spiro-noura*), 170.
brigantiaca (*Ostertagia*), 369.
bronchiorum suis (*Ascaris*), 387.
bufonis (*Ascaris*), 384.
Buissonia, 278.
Bunostomum, 331.
Bustomum, 331.
- Caconema*, 231.
caliciforme (*Cylicostomum*), 265.
calicatum (*Cyathostomum*), 267.
calicatum (*Cylichnostomum*), 267.
calicatum (*Cylicostomum*), 267.
calicatum (*Trichonema*), 267.
calicatum var. *minus* (*Cylicostomum*), 267.
calotis (*Strongyluris*), 145.
Cameloststrongylus, 366.
canina (*Uncinaria*), 320.
caninum (*Agchylostoma*), 320.
caninum (*Anchylostoma*), 320.
- caninum* (*Ancylostoma*), 319, 320.
caninum (*Ancylostomum*), 320.
caninum (*Ankylostoma*), 320.
caninum (*Ankylostomum*), 320.
caninum (*Sclerostoma*), 320.
caninus (*Strongylus*), 320.
canis (*Ascaris*), 62.
canis bronchialis (*Strongylus*), 396.
canis (*Lumbricus*), 59.
canis (*Strongyloides*), 216.
canis (*Toxocara*), 59.
Capillaria, 29.
Capillaria gastrica, 23.
capillaris (*Strongylus*), 372.
cati (*Ascaris*), 60, 62.
cati (*Belascaris*), 60.
catinatum (*Cyathostomum*), 273.
catinatum (*Cylichnostomum*), 273.
catinatum (*Cylicostomum*), 273.
catinatum (*Trichonema*), 273.
catinatum var. *pseudocatinatum* (*Trichonema*), 273, 274.
caudata (*Heterakis*), 121.
cebus (*Strongyloides*), 220.
cecidoplastes (*Anguil-lulina*), 231.
Cephaloststrongylus, 372.
Cerascaris, 79.
cernua (*Uncinaria*), 331.
cernuum (*Ankylostoma*), 331.
cernuum *Ankylostomum*), 331.
cernuus (*Dochmius*), 331.
cernuus (*Monodontus*), 331.
cernuus (*Strongylus*), 331.
cernuus (*Strongylus*), 367.
cervinus (*Hæmonchus*), 374.

- ceti* (*Odontobius*), 16.
Ceylancylostoma, 321, 322.
ceylanica (*Ascaris*), 83.
ceylanicum (*Agchylostoma*), 321.
ceylanicum (*Ancylostoma*), 321.
ceylanicum (*Ankylostoma*), 321.
ceylonica (*Ascaris*), 83.
Chabertia, 308.
chamaeleonis (*Strongyluris*), 142.
Characostomum, 328.
chilkensis (*Oncholaimus*), 243.
chiloscyllii (*Kathlania*), 160.
Chitinotylenchus, 226.
Chongianguium, 259.
Chongianguium sp., 261.
Chromadora, 243.
Chromadorella, 243.
Chromadorina, 243.
Chromadorissa, 243.
Chromadorita, 243.
circularis (*Ascaridia*), 141.
circumcincta (*Ostertagia*), 367.
circumcinctus (*Strongylus*), 367.
Cissophyllus, 181.
clathratum (*Sclerostoma*), 341.
clathratus (*Grammocephalus*), 341.
clathratus (*Strongylus*), 341.
cobi (*Bunostomum*), 333.
Cochlus, 107.
Codiostomum, 261.
coffæ (*Tylenchus*), 230.
colubriiformis (*Strongylus*), 362.
colubriiformis (*Trichostrongylus*), 362.
columbæ (*Ascaridia*), 137.
columbæ (*Ascaris*), 137.
columbæ (*Heterakis*), 137.
columbiana (*Hypostomum*), 297.
columbianum (*Æsophagostoma*), 297.
columbianum (*Æsophagostomum*), 297.
compar (*Ascaridia*), 135, 136.
compar (*Ascaris*), 136.
compar (*Fusaria*), 136.
compar (*Heterakis*), 136.
compar (*Oxyuris*), 205.
conicum (*Æsophagostomum*), 295.
connorfili (*Globocephalus*), 328, 329.
conoides (*Æsophagostomum*), 295.
Conoweberia, 291.
contortus (*Hæmonchus*), 374.
contortus (*Hæmonchus*), 378.
contortus (*Strongylus*), 308, 374.
Contracæcum, 24, 79.
Contracæcum, larval forms of, 92.
convolutus (*Strongylus*), 366.
cophotis (*Spinicauda*), 147.
coronata (*Ascaris*), 81.
coronatum (*Cyathostomum*), 270.
coronatum (*Cylichnostomum*), 270.
coronatum (*Cylicostomum*), 270.
coronatum (*Trichonema*), 270.
Cosmocercinæ, 200.
costatus (*Strongylus*), 385.
crassa (*Ascaris*), 69.
Crassisoma, 328.
crassum (*Porrocæcum*), 69.
crenulata (*Ascaris*), 62.
Criconema, 235.
criniformis (*Ascaris*), 337.
criniformis (*Strongylus*), 337.
cristata (*Ascaridia*), 139.
cristata (*Heterakis*), 139.
Crossocephalus, 209.
cruciata (*Atractis*), 208.
Cruzia, 179.
curvatum (*Æsophagostomum*), 291, 307.
curvatus (*Bosicola*), 307.
curvula (*Lepturis*), 185.
curvula (*Oxyuris*), 185.
Cyathostomum, 264.
Cylichnostomum, 264.
Cylicocercus, 272.
Cylicocyclus, 271.
Cylicostephanus, 265.
Cylicostomias, 268.
Cylicostomum, 268.
Cylicostomum, 264.
cymatostomum (*Cylichnostomum*), 275.
cymatostomum (*Cylicostomum*), 275.
cynonycteridis (*Ascaris*), 108.
Cystocephalus, 328.
dactyluris (*Atractis*), 207.
dactyluris var. *granulosa* (*Atractis*), 207.
dahomensis (*Heterakis*), 123.
decrusi (*Decrusia*), 252.
Decrusia, 251.
Delafondia, 251.
Deletrocephalus, 261.
delicatus (*Trichostrongylus*), 362.
delphini (*Ascaris*), 87.
dentatum (*Bunostomum*), 333.
dentatum (*Æsophagostomum*), 292.
dentatum (*Sclerostoma*), 292, 310.
dentatus (*Stephanurus*), 310.
dentatus (*Strongylus*), 292, 310.
Deontostoma, 244.
depressa (*Ascaris*), 70.
depressa (*Fusaria*), 70.
depressum (*Porrocæcum*), 70.
Desmodorinæ, 244.
diadonis (*Raphidascaaris*), 68.
Diaphanocephalidæ, 344.
Diaphanocephalus sp., 345, 356.
Dictyocaulus, 389.
diducta (*Bourgelatia*), 288.
digitatus (*Mecistocircus*), 382.

- digitatus* (*Nematodirus*), 382.
digitatus (*Strongylus*), 382.
dilatatum (*Æsophagostomum*), 306.
dilatatus (*Strongylus*), 306.
dimidiatus (*Deletrocephalus*), 262.
dimidiatus (*Strongylus*), 262.
 Diotrophymoidea, 9, 13.
Dipeltis, 240.
Diploodon, 317.
Diplopeltis, 240.
Discolaimus, 234.
Dochmius, 336.
Dochmoides, 336.
Dolichodoros, 226.
dorcadis (*Strongylus*), 389.
Dorylaimellus, 234.
Dorylaiminæ, 233.
Dorylaimus, 234.
Dorylaimus sp., 234.
Doryllium, 234.
Dujardinia, 95.
duodenale (*Agchylostoma*), 318.
duodenale (*Agchylostomum*), 318.
duodenale (*Ancylostoma*), 318.
duodenale (*Ancylostomum*), 318.
duodenale (*Ankylostoma*), 318.
duodenale (*Ankylostomum*), 318.
duodenale (*Sclerostoma*), 318.
duodenalis (*Dochmius*), 318.
duodenalis hominis (*Dochmius*), 318.
duodenalis (*Strongylus*), 318.
duodenalis (*Uncinaria*), 318.
duodenojejuna (*Ankylostoma*), 318.

edentatum (*Sclerostoma*), 250.
edentatus (*Strongylus*), 249, 250.

elephanti (*Strongylus*), 60.
elephantis (*Ascaris*), 60.
elephantis indici (*Strongylus*), 60.
elephantis (*Strongylus*), 60.
elephantis (*Toxocara*), 60.
elongatus (*Kalicephalus*), 349.
elongatus (*Metastrongylus*), 387.
elongatus (*Strongylus*), 387.
Endolaimus, 243.
engonium (*Contracæcum*), 85.
Enterobius, 188.
epistomum (*Choniamgium*), 260.
epistomum (*Sclerostoma*), 260.
Epomidiostomum, 360.
equi (*Mastigodes*), 185.
equi (*Oxyuris*), 185.
equi (*Trichocephalus*), 185.
equi (*Trichuris*), 185.
equinum (*Sclerostoma*), 248.
Equinurbia, 258.
equinus (*Strongylus*), 248.
equorum (*Ascaris*), 39.
equorum (*Parascaris*), 39.
equorum (*Strongylus*), 248.
ersiliæ (*Diaphanocephalus*), 355.
ersiliæ (*Kalicephalus*), 355.
ersiliæ (*Sclerostomum*), 355.
ersiliæ (*Strongylus*), 355.
escheri (*Rhabdias*), 215.
Ethmolaimus, 243.
Euchromadora, 243.
Eutylenchus, 226.
Evansia, 284.
exigua (*Meloidogyne*), 232.

falcata (*Falcaustra*), 168.
falcata (*Spirooura*), 168.
falcatum (*Oxysoma*), 168.
falcatum (*Spirooura*), 168.
Falcaustra, 163.
falcifer (*Cylicostoma*), 280.
falcifer (*Murshidia*), 280.
falcifer (*Strongylus*), 280.
falcifera (*Murshidia*), 280.
falciferum (*Cylicostomum*), 280.
feæ (*Heterakis*), 179.
felis (*Strongyloides*), 219.
filaria (*Ascaris*), 44.
filaria (*Dictyocaulus*), 389.
filaria (*Ophidascaris*), 44.
filaria (*Sclerostoma*), 389.
filaria (*Strongylus*), 389.
Filariidæ, 20.
Filarioidea, 11, 13.
filicollis (*Ascaris*), 380.
filicollis (*Fusaria*), 380.
filicollis (*Nematodirus*), 380.
filicollis (*Æsophagostomum*), 380.
filicollis (*Strongylus*), 380.
filicollis (*Trichostrongylus*), 380.
filiformis (*Ascaris*), 384.
filiformis (*Oswaldocruzia*), 384.
Fimbria, 238.
fimbriatus (*Kalicephalus*), 345, 354.
fimbriatus (*Occipitodontus*), 354.
Fimbrilla, 238.
fissicollis (*Ascaris*), 83.
Florenciaia, 163.
follicularis (*Strongylus*), 292.
fordi (*Mecistocirrus*), 382.
fordi (*Nematodirus*), 382.
fordini (*Mecistocirrus*), 382.
fordini (*Strongylus*), 382.

- fuligulæ* (*Amidostomum*), 357.
fülleborni (*Strongyloides*), 220.
funambulensis (*Laticuccana*), 151.
Fusarella, 188.
Fusaria, 35.
- Gaigeria**, 335.
galeocerdonis (*Porrocaecum*), 77.
galli (*Ascaridia*), 133.
galli (*Ascaris*), 133.
gallinæ (*Ascaris*), 112.
gallinæ (*Heterakis*), 112, 115.
gallopavonis (*Ascaris*), 133.
galloperdicis (*Subulura*), 153.
Galoncus, 323.
gangeticum (*Polycæcum*), 102.
gangula (*Ganguleterakis*), 123.
Ganguleterakis, 111.
gastrica (*Capillaria*), 23.
gavialidis (*Goezia*), 107.
gestri (*Ascaris*), 46.
gestri (*Ophidascaris*), 46.
gibbosa (*Ascaris*), 133.
gibsoni (*Nematodirus*), 382.
gibsoni (*Strongylus*), 382.
gigas (*Ascaris*), 36.
gigas equi (*Ascaris*), 39.
gigas hominis (*Ascaris*), 36.
gigas suis (*Ascaris*), 36.
gigas vituli (*Ascaris*), 41.
girardi (*Gireterakis*), 125.
girardi (*Heterakis*), 125.
Gireterakis, 111.
Globocephalus, 328.
globulus (*Ascaris*), 60.
Goezia, 107.
goldi (*Cylichnostomum*), 274.
goldi (*Cylicostomum*), 274.
goldi (*Trichonema*), 274.
- Gongylonema** *neoplasticum*, 23.
gongylophis (*Kalicephalus*), 348.
govindi (*Heterakis*), 126.
govindi (*Meteterakis*), 126.
graminearum (*Anguilula*), 226.
Grammocephalus, 341.
granulosa (*Ascaridia*), 133.
granulosa (*Atractis*), 207.
granulosa (*Heterakis*), 133.
Graphonema, 243.
Grosspiculagia, 370.
gulosus (*Tylenchus*), 230.
- Hæmonchus**, 373.
hæmonchus (*Strongylus*), 374.
haliaëti (*Contracæcum*), 83.
halichoris (*Dujardinia*), 99.
halicoris (*Ascaris*), 99.
halicoris (*Dujardinia*), 99.
hamia (*Ascaridia*), 133.
hamulus (*Heterakis*), 123.
harkeri (*Strongylus*), 366.
hastata (*Heterakis*), 119.
helicina (*Ascaris*), 96.
helicina (*Dujardinia*), 96.
hemidactylus (*Thelandros*), 196.
Hemipsilus, 244.
Henryella, 278.
Heterakidæ, 6, 11, 17, 110.
Heterakinæ, 110.
Heterakis, 111, 206.
Heterobolbus, 231.
Heterodera, 12, 231.
hexacanthum (*Sclerostoma*), 269.
Hexametra, 48.
Hexodontostomum, 276.
Hologonia, 13.
hominis (*Ankylostoma*), 318.
- hominis* (*Rhabdonema*), 216.
hominis (*Uncinaria*), 318.
Hoplolaimus, 235.
Hypostomum, 290.
hypostomum (*Sclerostoma*), 308, 331.
hypostomum (*Sclerostomum*), 308.
hypostomus (*Dochmius*), 308, 331.
hypostomus (*Strongylus*), 308.
Hysteracrum, 291.
- ibidis* (*Belanisakis*), 67.
Ihleia, 291.
imparidentatum (*Poteriostomum*), 276.
incognita (*Oxyuris*), 232.
incurva (*Ascaris*), 88.
incurvum (*Contracæcum*), 88.
indica (*Heterakis*), 115.
indica (*Mermis*), 225.
indica (*Murshidia*), 281.
indica (*Pteridopharynx*), 281.
indica (*Syphaciella*), 203.
indicum (*Leptosomatium*), 245.
indicum (*Æsophogostomum*), 299.
indicum (*Thoracostoma*), 245.
indicus (*Kalicephalus*), 347.
indicus (*Oncholaimus*), 242.
indicus (*Syngamus*), 315.
inflatum (*Æsophogostomum*), 306.
inflatum var. *ovis* (*Æsophagostoma*), 296.
inflatus (*Strongylus*), 306.
inflexa (*Ascaris*), 133.
inflexa (*Fusaria*), 133.
inflexa (*Heterakis*), 133.
infundibulicola (*Ascaris*), 44.

- insigne* (*Cylichnostomum*), 271.
insigne (*Cylicostomum*), 271.
insigne (*Trichonema*), 271.
instabilis (*Strongylus*), 362.
intermedius (*Triodontophorus*), 254.
intestinale (*Rhabdonema*), 216.
intestinalis (*Anguillula*), 216.
intestinalis (*Ascaris*), 384.
intestinalis (*Leptodera*), 216.
intestinalis (*Pseudorhabditis*), 216.
intestinalis (*Rhabditis*), 216.
intestinalis (*Stercoralis*), 216.
intestinalis (*Strongyloides*), 216.
Iota, 235.
Iotonchium, 226.
isolonche (*Heterakis*), 119.

Jägerskiöldia, 244.
javanica (*Heterodera*), 232.

kachugæ (*Atractis*), 213.
kachugæ (*Falcaustra*), 168.
kachugæ (*Monhysterides*), 213.
kachugæ (*Oxysoma*), 168.
kachugæ (*Spiro-noura*), 168.
Kalicephalus, 344.
Kalicephalus sp., 356.
kasauli (*Thelandros*), 195.
kashinathi (*Bunostomum*), 331, 333.
Kathlania, 158.
Kathlaniidæ, 11, 158.
Kathleena, 79.
kathlena (*Kathlania*), 159.
kempi (*Zanclophorus*), 177.
Khalilia, 282.
Kiluluma, 286.
Krikonema, 235.

labiatum (*Cylichnostomum*), 270.
labiatum (*Cylicostomum*), 270.
labiatum (*Trichonema*), 270.
lævissima (*Ascaris*), 39.
lagopodis (*Ascaris*), 136.
lamellaris (*Typhlophoros*), 104.
lanei (*Heterakis*), 119.
larynceus (*Syngamus*), 315.
larynceus minor (*Syngamus*), 315.
laryngeus (*Syngamus*), 315.
Latibuccana, 150.
laverani (*Cissophyllus*), 181.
Lecanocephalus, 107.
leonina (*Ascaris*), 62.
leonina (*Toxascaris*), 62.
leptocephala (*Falcaustra*), 167.
leptocephala (*Spiro-noura*), 167.
leptocephalum (*Spiro-noura*), 167.
Leptodera, 214.
leptoptera (*Ascaris*), 62.
Leptosomatides, 244.
leptura (*Ascaris*), 159.
leptura (*Kathlania*), 159.
leptura (*Pseudoheterakis*), 159.
Lepturis, 185.
lepturum (*Oxysoma*), 159.
Libyostrogylus, 362.
limbata (*Toxascaris*), 62.
lineata (*Ascaridia*), 133.
lineata (*Heterakis*), 133.
lobulata (*Ascaris*), 87.
lobulatum (*Contracæcum*), 87.
Lombricoides, 35.
lonchoptera (*Ascaris*), 60.
lonchoptera (*Belascaris*), 60.
longe-caudata (*Heterakis*), 112.
longespiculum (*Heterakis*), 131.

longespiculum (*Uncinaria*), 338.
longevaginatus (*Eustrongylus*), 387.
longevaginatus (*Metastrongylus*), 387.
longevaginatus (*Strongylus*), 387.
longibursatum (*Cylicostomum*), 265.
longibursatum (*Trichonema*), 265.
longicaudata (*Oxyuris*), 205.
longicaudum (*Æsophagostomum*), 294.
Longidorus, 234.
longior (*Kalicephalus*), 348.
longistipes (*Hæmonchus*), 378.
longum (*Rhabdonema*), 220.
longus bovis (*Strongyloides*), 220.
longus (*Rhabdonema*), 220.
longus (*Strongyloides*), 220.
lumbricoides (*Ascaris*), 36.
lumbricoides equorum (*Fusaria*), 39.
lumbricoides hominum (*Fusaria*), 36.
lumbricoides suis (*Fusaria*), 36.
lumbricoides suum (*Fusaria*), 36.

macintoshii (*Oxysoma*), 201.
macintoshii (*Oxysomatium*), 201.
macintoshii (*Oxyso-moides*), 201.
maculosa (*Ascaridia*), 137.
maculosa (*Ascaris*), 137.
maculosa (*Fusaria*), 137.
maculosa (*Heterakis*), 137.
major (*Syngamus*), 315.
malayana (*Uncinaria*), 322.
malayanicum (*Ancylostoma*), 322.

- malayanum* (*Agchylostoma*), 322.
malayanum (*Ancylostoma*), 322.
malayanum (*Ankylostoma*), 322.
maplestonei (*Kalicephalus*), 347.
maplestonei (*Esophagostomum*), 295.
maplestoni (*Esophagostomum*), 295.
maplestoni (*Parapharyngodon*), 195.
maplestoni (*Thelandros*), 195.
marginata (*Ascaris*), 59.
marginata (*Belascaris*), 59.
marginata (*Toxascaris*), 62.
marioni (*Anguillula*), 232.
marioni (*Heterodera*), 232.
markusi (*Hexodontostomum*), 276.
Marshallagia, 369.
marshalli (*Ostertagia*), 369.
mastigoides (*Oxyuris*), 185.
mastigodes (*Oxyuris*), 185.
mauritanicus (*Nematodirus*), 381.
Mecistocirrus, 382.
megalaima (*Monhystera*), 237.
megalocephala (*Ascaris*), 39.
megaloon (*Oxyuris*), 197.
meissneri (*Mermis*), 222.
meleagrinae (*Ascaris*), 94.
meleagris gallopavonis (*Strongylus*), 312.
Meloidogyne, 231.
Memphisia, 278.
mentulata (*Ostertagia*), 372.
mentulatus (*Camelostrongylus*), 372.
Mermis, 21, 27, 222.
Mermis sp., 224.
Mermithidæ, 17, 21, 221.
Metastrongylidæ, 386.
Metastrongylus, 387.
Meteterakis, 111.
Metoncholaimus, 241.
microcephala (*Ascaris*), 81.
microcephalum (*Contracæcum*), 81.
microptera (*Ascaris*), 62.
microptera (*Toxascaris*), 62.
micruris (*Thelandros*), 192.
micrurus (*Dictyocaulus*), 391.
micrurus (*Metastrongylus*), 391.
micrurus (*Strongylus*), 391.
minima (*Uncinaria*), 321.
minimum (*Ancylostoma*), 321.
minimum (*Ankylostomum*), 321.
minor (*Dipeltis*), 240.
minor (*Diplopeltis*), 240.
minor (*Triodontophorus*), 254.
minor (*Triodontus*), 254.
minutum (*Cylicostomum*), 267.
minutum (*Trichonema*), 267.
minutus (*Diaphanocephalus*), 351.
minutus (*Kalicephalus*), 351.
Monhystera, 236.
Monhysterides, 210.
Monodontus, 331.
Monohystera, 236.
Mononchus, 16.
monticelliana (*Heterakis*), 121.
morai (*Stephanurus*), 310.
Multicæcum, 100.
multipapillata (*Allo-dapa*), 156.
multipapillata (*Subulura*), 156.
murshida (*Murshidia*), 278.
Murshidia, 278.
mystax (*Ascaris*), 60.
mystax (*Belascaris*), 60.
mystax (*Fusaria*), 60.
mystax (*Toxocara*), 60.
naiæ (*Ascaris*), 46.
naiæ (*Kalicephalus*), 351.
naïæ (*Ophidascaris*), 46.
nanum (*Cylicostomum*), 265.
nassatum (*Cyathostomum*), 272.
nassatum (*Cylichnostomum*), 272.
nassatum (*Cylicostomum*), 272.
nassatum (*Trichonema*), 272.
nassatum var. *parvum* (*Trichonema*), 272.
nattereri (*Stephanurus*), 310.
Necator, 326.
Necatorinae, 326.
neglectus (*Aphelenchus*), 230.
neglectus (*Strongylus*), 248.
Nematevansia, 284.
Nematodirus, 379.
Neoscaris, 35.
neoplastica (*Heterakis*), 119.
neoplasticum (*Gongy-lonema*), 23.
nigrescens (*Mermis*), 222.
Nycolaimus, 234.
obvelata (*Syphacia*), 199.
occidentalis (*Ostertagia*), 370.
Occipitodontus, 344.
ocellata (*Chromadora*), 244.
ocellata (*Phanoglene*), 244.
ocellata (*Urolabes*), 244.
octodactyla (*Cloacina*), 387.
oculata (*Ascaris*), 52.
oculata (*Polydelphis*), 52.

- Odontobius ceti*, 16.
Odontocricus, 243.
Œsophagodontus, 256.
Œsophagostominæ, 290.
Œsophagostomoides, 290, 291.
Œsophagostomum, 290, 291.
Ogma, 235.
omra (*Amira*), 282.
onama (*Spirooura*), 173.
Oncholaimidæ, 241.
Oncholaiminæ, 241.
Oncholaimus, 241.
opeatura (*Atractis*), 208.
Ophidascaris, 44.
orientalis (*Cruzia*), 180.
orientalis (*Ostertagia*), 369.
Ornithostrongylus, 372.
osleri (*Filaria*), 396.
osleri (*Filaroides*), 396.
osleri (*Oslerus*), 396.
osleri (*Pseudalius*), 396.
Oslerus, 395.
os-papillatum (*Uncinaria*), 343.
ostertagi (*Ostertagia*), 366.
ostertagi (*Strongylus*), 366.
Ostertagia, 366.
Oswaldocruzia, 384.
ovatum (*Œsophagostomum*), 302.
ovatus (*Strongylus*), 302.
ovina (*Chabertia*), 308.
ovinum (*Sclerostomum*), 308.
ovinus (*Strongylus*), 308.
ovis (*Ascaris*), 36.
ovocinctus (*Strongyloides*), 220.
Oxysoma, 158, 179, 200.
Oxysomatium, 200.
Oxysomoides, 200.
Oxyurias, 188.
Oxyuridæ, 6, 9, 12, 14, 17, 184.
Oxyurinæ, 184.
Oxyuris, 7, 185.
Oxyuris sp., 204, 205.
Oxyuroidea, 33.
pachyscelis (*Gaigeria*), 335.
palustris (*Dorylaimus*), 234.
palustris (*Urolabes*), 234.
papillosa (*Ascaris*), 112, 121.
papillosa (*Fusaria*), 121.
papillosa (*Heterakis*), 121.
papillosa (*Heterakis*), 112, 121.
papillosum (*Trichosoma*), 220.
papillosus (*Strongyloides*), 220.
paradoxus (*Metastrongylus*), 387.
paradoxus (*Strongylus*), 387.
Paramonohystera, 236.
Paranisakis, 92.
Parapharyngodon, 192.
Paraquilonia, 284.
Parascaris, 35.
Parasitylenchus, 226.
Paratylenchus, 226.
parisi (*Heterakis*), 112.
parva (*Heterakis*), 118.
parvus (*Kalicephalus*), 347.
pastinacæ (*Ascaris*), 92.
pastinacæ (*Paranisakis*), 92.
pateratum (*Cylicostomum*), 275.
pateratum (*Trichonema*), 275.
pavonis (*Heterakis*), 115.
pavonis (*Pseudaspido-dera*), 115, 128.
penetrans (*Tylenchus*), 230.
Penzancia, 236.
perniciosa (*Uncinaria*), 323.
perniciosum (*Ancylostoma*), 323.
perniciosum (*Ankylostomum*), 323.
perniciosus (*Galonus*), 323.
perspicillum (*Ascari- dia*), 133.
perspicillum (*Ascaris*), 133.
perspicillum (*Heterakis*), 133.
philippinensis (*Uncinaria*), 338.
phlebotomum (*Bunostomum*), 334.
phlebotomum (*Bustomum*), 334.
phlebotomus (*Monodontus*), 334.
Physaloptera, 6.
pictus (*Strongylus*), 312.
pigmentatus (*Strongylus*), 365.
pigmentatus (*Trichostrongylus*), 365.
pileata (*Amira*), 282.
pileata (*Khalilia*), 282.
pileatum (*Cylicostomum*), 282.
pinguiola (*Sclerostoma*), 310.
pinguicola (*Strongylus*), 310.
piscicola (*Monhysteri- des*), 211.
plagiostomorum (*Ascaris*), 90.
plagiostomorum (*Con- tracæcum*), 90.
Pleuromyarii, 9.
pluridentatum (*Poterio- stomum*), 276.
pneumonicus (*Vare- strongylus*), 393.
poculatum (*Cyathosto- mum*), 268.
poculatum (*Cylichno- stomum*), 268.
poculatum (*Cylicosto- mum*), 268.
poculatum (*Trichone- ma*), 268.
poculum (*Oxyuris*), 188.
polaris (*Uncinaria*), 337.
pollicaris (*Ascaris*), 189.
Polycæcum, 102.
Polydelphis, 48.
Polydelphis sp., 58.
Polysigma, 243.
Porrocæcum, 24, 69.
Porrocæcum sp., 78.
Poteriostomum, 276.
pratensis (*Anguillu- lina*), 230.

- pratensis* (*Tylenchus*), 230.
primitivus (*Strongylus*), 312.
primitivus (*Syngamus*), 312.
Prionoderma, 107.
pristis (*Porrocæcum*), 75.
probolurus (*Strongylus*), 364.
probolurus (*Trichostrongylus*), 364.
Probstmayria, 182.
Prochromadora, 243.
procyonis (*Tetragomphus*), 339.
Prooncholaimus, 241.
Proteracrum, 291.
Protostrongylidæ, 386.
Protostrongylus, 394.
Pseudaliidæ, 386.
Pseudamidostomum, 359.
Pseudaspidodera, 127.
pseudo-catinatum (*Cylicostomum*), 274.
Pseudoheterakis, 158.
Pseudorhabditis, 215.
Pseudosclerostomum, 256.
Pteridopharynx, 278.
Pterocephalus, 209.
Pterygopharynx, 278.
Ptycholaimellus, 243.
pulmonalis apri (*Gordius*), 387.
pulmonaris (*Strongylus*), 391.
pusilla (*Heterakis*), 116.
putaustralis (*Heterakis*), 119, 122.
pythonis (*Ascaris*), 49, 51.

quadrata (*Ascaris*), 78, 92.
quadricuspe (*Contracæcum*), 81.
quadridentatum (*Sclerostoma*), 269.
quadrispinulatum (*Æsophagostomum*), 294.
Quasiststrongylus, 261.
quilona (*Quilonia*), 284.
Quilonia, 284.

radiata (*Uncinaria*), 334.
radiatum (*Ankylostoma*), 306.
radiatum (*Bunostomum*), 334.
radiatum (*Æsophagostomum*), 291.
radiatum (*Æsophagostomum*), 306.
radiatus (*Bosicola*), 306.
radiatus (*Dochmius*), 334.
radiatus (*Strongylatus*), 334.
radiatus (*Strongylus*), 306, 334.
radicicola (*Caconema*), 232.
radicicola (*Heterodera*), 232.
radicicola (*Tylenchus*), 232.
radicola (*Anguillula*), 232.
radicus (*Kalicephalus*), 348.
raillieti (*Æsophagostomum*), 302.
Raillietoststrongylus, 328.
ranæ (*Cucullanus*), 384.
Raphidascaris, 67.
renium (*Sclerostomum*), 310.
renniei (*Evansia*), 284.
renniei (*Nematevansia*), 284.
renniei (*Quilonia*), 284.
Resorbentes, 9.
reticulata (*Ascaris*), 74.
reticulatum (*Porrocæcum*), 74.
Rhabdias, 214.
Rhabditidæ, 9, 214.
Rhabditinæ, 214.
Rhabdonema, 214, 215.
rheæ (*Quasiststrongylus*), 262.
robustum (*Sclerostoma*), 256.
robustus (*Æsophagodontus*), 256.
rosarium (*Contracæcum*), 82.
rosarius (*Ascaris*), 82.
rotundicaudata (*Ascaris*), 56.
rotundicaudata (*Polydelphis*), 56.

rubicunda (*Ascaris*), 44, 51.
rufescens (*Dictyocaulus*), 394.
rufescens (*Metastrongylus*), 394.
rufescens (*Protostrongylus*), 394.
rufescens (*Sclerostoma*), 394.
rufescens (*Strongylus*), 394.
rufescens (*Synthetocaulus*), 394.

samoensis (*Globocephalus*), 330.
sangeri (*Bathmostomum*), 343.
sangeri (*Dochmius*), 343.
sangeri (*Uncinaria*), 343.
sarasinorum (*Filaria*), 153.
sarasinorum (*Subulura*), 153.
scandens (*Anguillula*), 226.
scandens (*Tylenchus*), 226.
sciuri (*Oxyuris*), 204.
sciuri (*Syphacia*), 198.
Sclerostoma, 247.
Sclerostomum, 247.
Secernentes, 9.
securiferum (*Pseudosclerostomum*), 256.
serpentulus (*Ascaris*), 73.
serratus (*Triodontophorus*), 254.
serratus (*Triodontus*), 254.
sewelli (*Polydelphis*), 54.
simiæ (*Probstmayria*), 183.
simiæ (*Strongyloides*), 220.
similis (*Anguillulina*), 228.
similis (*Hæmonchus*), 378.
similis (*Tylenchus*), 228.

- sipunculiforme* (*Cylico-*
stomum), 258.
sipunculiforme (*Sclero-*
stoma), 258.
sipunculiformis (*Equi-*
nurbia), 258.
skrjabini (*Amidosto-*
mum), 357.
skrjabini (*Ostertagia*),
 370.
smiti (*Gaigeria*), 335.
Sonsinia, 147.
spathiger (*Nematodi-*
rus), 381.
Sphaerularia, 17.
spiculigera (*Ascaris*),
 79.
spiculigerum (*Contra-*
cæcum), 79.
Spilipherella, 243.
Spilophorella, 243.
Spinicauda, 147.
spinosa (*Pseudaspido-*
dera), 132.
spinuliferum (*Sclero-*
stoma), 258.
Spirocerca, 20, 22.
Spirooura, 163.
Spirura, 163.
Spiruridæ, 19.
Spiuroidea, 19.
spumosa (*Gangulctera-*
kis), 123.
spumosa (*Heterakis*),
 123.
squamosa (*Iota*), 235.
squamosus (*Hoplolai-*
mus), 235.
Steinera, 236.
stenocephala (*Doch-*
moides), 337.
stenocephala (*Uncina-*
ria), 337.
stenocephalum (*Anky-*
lostoma), 337.
stenocephalum (*Anky-*
lostomum), 337.
stenocephalus (*Doch-*
mius), 337.
Stephanurinæ, 309.
Stephanurus, 309.
Stercoralis, 215.
stercoralis (*Anguillula*),
 216.
stercoralis (*Leptodera*),
 216.
stercoralis (*Pseudo-*
rhabditis), 216.
stercoralis (*Rhabditis*),
 216.
stercoralis (*Rhabdone-*
ma), 216.
stercoralis (*Strongy-*
loides), 216.
stercoralis var. *felis*
 (*Strongyloides*), 216,
 219.
stewarti (*Falcaustra*),
 171.
stewarti (*Spirooura*),
 171.
Stomachida, 35.
stroma (*Ascaridia*),
 140.
stroma (*Heterakis*),
 140.
stroma (*Syphacia*),
 199.
Strongylidæ, 246.
Strongylinæ, 247.
Strongyloidea, 2, 6, 8,
 11, 13, 15, 17, 19,
 246.
Strongyloides, 19, 215.
strongyloides (*Anguil-*
lula), 216.
strongyloides (*Lepto-*
dera), 216.
strongyloides (*Rhabdi-*
tis), 216.
strongyloides (*Rhabdo-*
nema), 216.
Strongyluris, 142.
Strongylus, 247, 248.
stylosa (*Heterakis*), 121.
stylosa (*Kiluluma*),
 287.
stylosus (*Delethroceph-*
alus), 287.
subnigrescens (*Mermis*),
 222.
subtilis (*Strongylus*),
 362.
subtilis (*Trichostrongy-*
lus), 362.
subulata (*Atractis*), 208.
subulatum (*Æsophago-*
stomum), 292.
Subulura, 150.
Subulurinæ, 150.
suilla (*Ascaris*), 36.
suillus (*Necator*), 327.
suis (*Ascaris*), 36.
suis (*Æsophagosto-*
mum), 294.
suis (*Rhabdonema*), 220.
suis (*Strongyloides*),
 220.
suis (*Strongylus*), 387.
suum (*Ascaris*), 36.
Symplocostoma, 239.
Syngaminæ, 312.
Syngamus, 312.
syngamus (*Sclerosto-*
ma), 312.
Synthetocaulus, 394.
Syphacia, 198.
Syphacia spp., 199.
Syphaciella, 202.
Tachyhodites, 236.
tæniuræ (*Paranisakis*),
 92.
tagumai (*Mecistocir-*
rus), 382.
taylori (*Thelandros*),
 194.
Telogonia, 13.
tenuicauda (*Oxyuris*),
 185.
tenuis (*Fimbria*), 238.
tenuis (*Fimbrilla*), 238.
tenuissima (*Ascaris*),
 384.
teres (*Ascaris*), 133.
teres hominis (*Lumbric-*
us), 36.
teres (*Lumbricus*), 36.
teres vituli (*Lumbricus*),
 41.
Terranova, 69.
testudinis (*Falcaustra*),
 164.
testudinis (*Spiro-*
oura), 164.
tetracanthum (*Cyatho-*
stomum), 269.
tetracanthum (*Cylich-*
nostomum), 269.
tetracanthum (*Cylicosto-*
mum), 269.
tetracanthum (*Sclero-*
stomum), 269.
tetracanthus (*Strongy-*
lus), 269.
Tetragomphius, 339.
Thelandros, 192.
Theristus, 236.
Thoracostoma, 244.
tigridis (*Ascaris*), 109.
tigridis (*Fusaria*), 109.
Tonaudia, 162.
tonaudia (*Kathlania*),
 162.
tonaudia (*Tonaudia*),
 162.
Toxascaris, 62.
Toxocara, 58.

- trachea* (*Fasciola*), 312.
trachea (*Syngamus*), 312.
tracheale (*Sclerostoma*), 312.
trachealis (*Filaria*), 387.
trachealis (*Strongylus*), 312.
trachealis (*Syngamus*), 312.
traguli (*Bosicola*), 307.
traguli (*Bourgala-tioides*), 291, 307.
traguli (*Æsophagostomoides*), 291, 304.
traguli (*Æsophagostomum*), 304.
transfuga (*Ascaris*), 63.
transfuga (*Toxascaris*), 63.
travancra (*Evansia*), 286.
travancra (*Nematevansia*), 286.
travancra (*Quilonia*), 286.
travassosi (*Ornithostrongylus*), 373.
Trichinelloidea, 5, 9, 13.
trichiuri (*Contracæcum*), 91.
Trichonema, 264, 265.
Trichoneminæ, 264.
Trichostrongylidæ, 2, 361.
Trichostrongylinæ, 361.
Trichostrongylus, 362.
tricoloris (*Bosicola*), 306.
tricuspe (*Contracæcum*), 84.
tricuspis (*Kathleena*), 84.
tricuspis (*Ostertagia*), 369.
tridentatum (*Æsophagostomum*), 291, 303.
trifida (*Ostertagia*), 370.
trigonocephala (*Uncinaria*), 320, 331.
trigonocephalum (*Anchylostomum*), 320.
trigonocephalum (*Ankylostoma*), 320, 337.
trigonocephalum (*Ankylostomum*), 320.
trigonocephalum (*Bunostomum*), 320, 331.
trigonocephalus (*Dochmius*), 320, 337.
trigonocephalus (*Monodontus*), 331.
trigonocephalus (*Strongylus*), 320, 331, 337.
trilabium (*Ascaridia*), 140, 141.
trilabium (*Heterakis*), 141.
Trilobidæ, 236.
Triodontophorus, 253.
Triodontus, 253.
triquetra (*Ascaris*), 59.
triquetra (*Fusaria*), 59.
tritici (*Anguillula*), 226.
tritici (*Anguillulina*), 226.
tritici (*Rhabditis*), 226.
tritici (*Tylenchus*), 226.
tritici (*Vibrio*), 226.
Trypanoxyuris, 188.
tubæforme (*Ankylostomum*), 320.
tubæformis (*Strongylus*), 320, 323.
tubæformis (*Uncinaria*), 320.
turnicis (*Subulura*), 154.
Tylenchus, 226.
Tylenchidæ, 225.
Tylenchorhynchus, 226.
Tylenchus, 226.
Typhlophoros, 104.
Uncinaria, 336.
uncinatum (*Epomidiostomum*), 360.
uncinatus (*Strongylus*), 360.
unequalis (*Dictyocaulus*), 391.
uria (*Monhystera*), 237.
urosubulatum (*Crassisoma*), 328.
urosubulatus (*Globocephalus*), 328.
varani (*Africana*), 149.
varani (*Amplicæcum*), 105.
varedatus (*Grammocephalus*), 341.
Varestrongylus, 392.
variabilis (*Heterakis*), 119.
variegata (*Ascaris*), 79.
vasifa (*Asifia*), 260.
venulosum (*Æsophagostomum*), 296.
venulosus (*Strongylus*), 296.
vermicularis (*Ascaris*), 189.
vermicularis (*Enterobius*), 189.
vermicularis (*Fusarella*), 189.
vermicularis (*Fusaria*), 189.
vermicularis (*Oxyurias*), 189.
vermicularis (*Oxyuris*), 189.
vesicularis (*Ascaris*), 112.
vesicularis (*Heterakis*), 112.
vesiculosum (*Æsophagostomum*), 306.
vialæ (*Anguillula*), 232.
vicarius (*Strongylus*), 367.
Viscosia, 241.
vituli (*Ascaris*), 41, 391.
vituli (*Fusaria*), 391.
vituli (*Strongyloides*), 220.
vitulorum (*Ascaris*), 39, 41.
vitulorum (*Neoascaris*), 41.
vitulorum (*Strongylus*), 391.
viviparus (*Dictyocaulus*), 391.
viviparus (*Gordius*), 391.
voluptuosa (*Pseudaspidodera*), 131.
voluptuosa var. *minor* (*Pseudaspidodera*), 131.
voluptuosus (*Pseudaspidodera*), 131.
vryburgi (*Agriostomum*), 324.

- vulgare* (*Sclerostoma*), 251.
vulgaris (*Strongylus*), 249, 251.
vulpis (*Ascaris*), 59.
vulpis (*Belascaris*), 59.
vulvolabiata (*Heterakis*), 118.
vulvolabita (*Heterakis*), 118.
- wedlii* (*Monodontus*), 331.
 Wellcomeia, 206.
willeyi (*Diaphanocephalus*), 345, 354.
willeyi (*Kalicephalus*), 345.
willeyi (*Kalicephalus*), 354.
woodlandi (*Dujardinia*), 97.
- Zanclophorus*, 174.
zebræ (*Cylichnostomum*), 276.
zebræ (*Cylicostomum*), 271.
zeylanica (*Ascaris*). 83.

